

MULTISTANDARD CMOS IC OF SINGLE CHIP PHONE WITH DOUBLE SOFT LIMITATION

Description

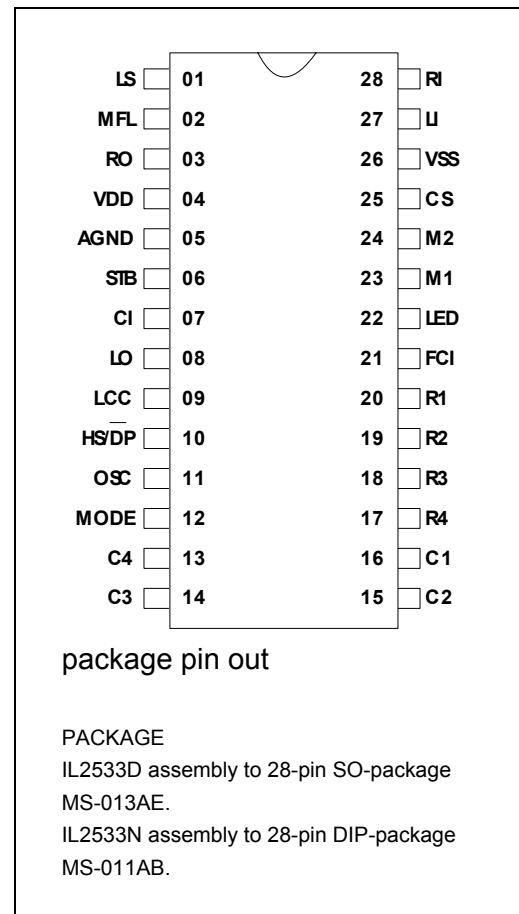
IL2533N, IL2533D is CMOS IC, supporting all functions, necessary for design of electronic telephone with high characteristics. Standard application circuit is shown at figure 2.

Device includes LD/MF constant automatic dialer, melodies generation, ring frequency identification and high quality circuit for line/speech.

RAM at chip, intended for redialing of 31-digit number and memory elements, containing upto 21 symbols/data. Floating marker method enables to use LNR function under control of different PABX systems. Device contains volume control of hearing aid. Volume is controlled by VOL button (5.4dB) or "-/+ " button (plus 8.1/minus 5.4dB in 5 levels).

Main features

- Line/speech circuit. LD/MF constant automatic dialer and tone ring at one 28-pin CMOS chip.
- Operational range 13 to 100 mA (decreasing upto 5 mA causes productivity deterioration).
- Soft limitation for elimination of drastic distortion.
- Controlling of received signal volume.
- Automatic line loss compensation.
- Low noise level (max – 72 dBmp).
- Actual or complex impedance.
- Switching LD/MF dialing.
- Tone damper during programming.
- Redial of the last 31 digit number.
- Reference storage.
- Redial of busy line or previous connection.
- Pause button for applying to pause or waiting function.
- 3 pulse flashes: buttons, "R1" – 100 ms, "R2" – 280 ms and "R3" – 375/600 ms.
- Active RC-filter on chip.
- Circuit of ring frequency determination.
- Three-tone melody generator



Versatility of the circuit provides possibility of variants selecting on circuit's pin and several outer components. It allows adapting easily to the requirements of different standard (post, telephone and telegraph). Description of circuits' pins is shown at table 1.

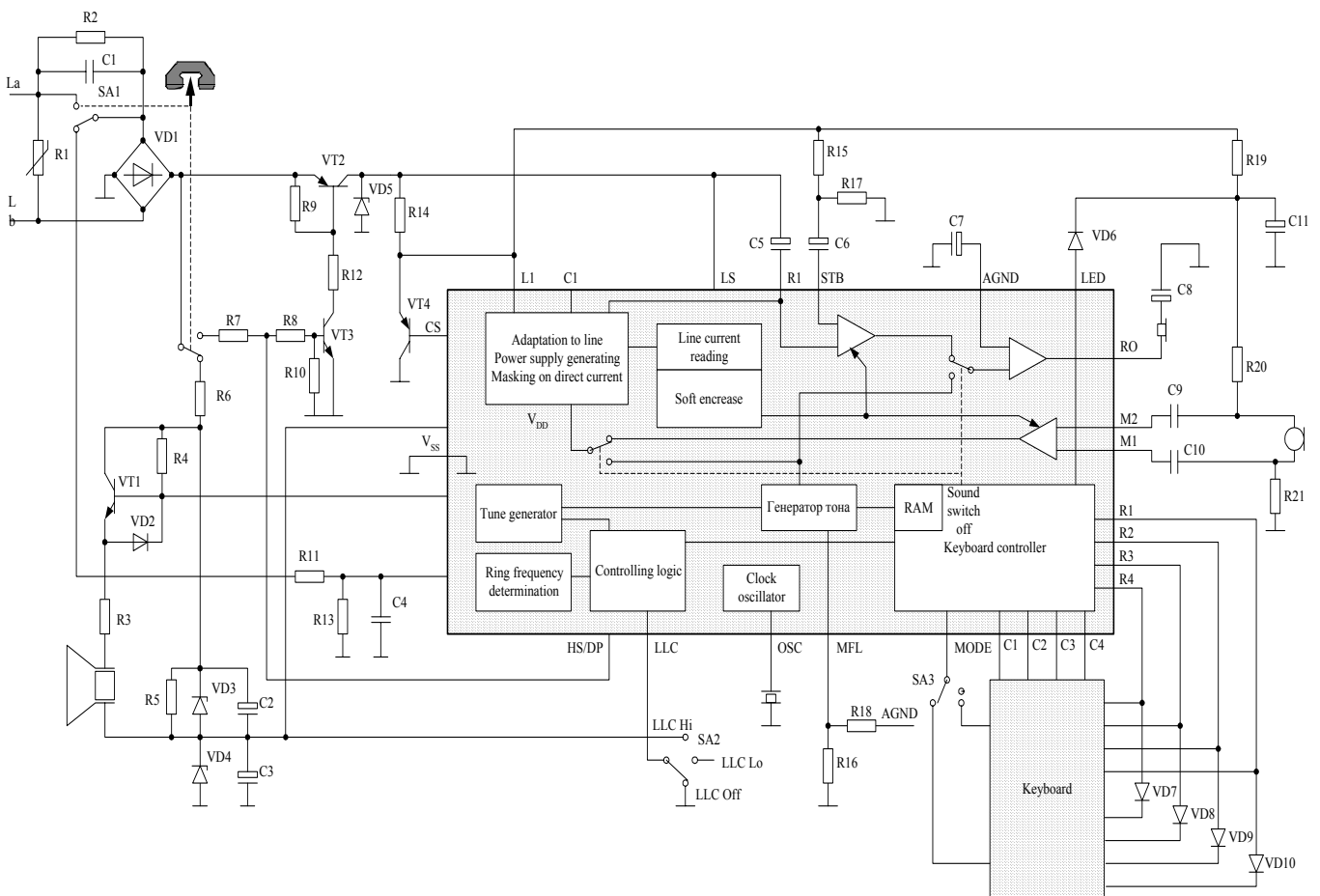


Figure 2 – Typical application flow-chat

Table 1 – Circuit pins description

Pin No	Pin letter symbol	Function																				
01	LS	Line current input. Input for line current determination (responsibility setup)																				
02	MFL	MF level setup. For DTMF level setup can be used potential divider, connected from this pin to A _{GND} and to V _{SS}																				
03	RO	Receipt output Output for controlling of dynamic hearing aid with impedance from 140 to 300 Ohm																				
04	V _{DD}	Positive supply voltage. Supply voltage output for circuit																				
05	A _{GND}	Analog ground, Analog ground for amplifiers																				
06	STB	Balanced input side tone. Input for side tone suppression																				
07	CI	Entire impedance output. For complex impedance, capacitor should be connected to this output																				
08	MO	Melody output. Melody generator PWM-output for tone ring. When output not active, in "Switch off" state																				
09	LLC	Line waste compensation. Selected output for loss compensation in line. LLC=A _{GND} : 20-50 mA; LLC=V _{DD} : 45-75 mA; LLC=V _{SS} :no compensation																				
10	HS/DP	Switch hook input and output of pulse dialing. Analog input/output, establishing by high switch hooks by off-hook and open drain set it in low state during interruptions for pulse dialing and flash pulses																				
11	OSC	Oscillator input. Input for ceramic resonator (3.5 MHz)																				
12	MODE	Input of mode denomination selection. <table border="1" style="margin-left: 20px;"> <thead> <tr> <th>Mode output</th> <th>Function</th> </tr> </thead> <tbody> <tr> <td>Open</td> <td>Interlocking number dialing</td> </tr> <tr> <td>Row 1</td> <td>LD mode, 10 pulse/s, 33/66ms</td> </tr> <tr> <td>Row 2</td> <td>LD mode, 10 pulse /s , 40/60ms</td> </tr> <tr> <td>Row 3</td> <td>LD mode, 20 pulse /s , 16/33ms</td> </tr> <tr> <td>Row 4</td> <td>LD mode, 20 pulse /s , 20/30ms</td> </tr> <tr> <td>Row 5</td> <td>LD mode, 10 pulse /s, 33/66ms. Temporary MF with tone on first button input "*"</td> </tr> <tr> <td>Row 6</td> <td>Only MF, 82/82ms</td> </tr> <tr> <td>Row 7</td> <td>Only MF, 82/160ms</td> </tr> <tr> <td colspan="2">Note – Pulse/s — pulses per second. During temporary MF : 82/160ms</td> </tr> </tbody> </table>	Mode output	Function	Open	Interlocking number dialing	Row 1	LD mode, 10 pulse/s, 33/66ms	Row 2	LD mode, 10 pulse /s , 40/60ms	Row 3	LD mode, 20 pulse /s , 16/33ms	Row 4	LD mode, 20 pulse /s , 20/30ms	Row 5	LD mode, 10 pulse /s, 33/66ms. Temporary MF with tone on first button input "*"	Row 6	Only MF, 82/82ms	Row 7	Only MF, 82/160ms	Note – Pulse/s — pulses per second. During temporary MF : 82/160ms	
Mode output	Function																					
Open	Interlocking number dialing																					
Row 1	LD mode, 10 pulse/s, 33/66ms																					
Row 2	LD mode, 10 pulse /s , 40/60ms																					
Row 3	LD mode, 20 pulse /s , 16/33ms																					
Row 4	LD mode, 20 pulse /s , 20/30ms																					
Row 5	LD mode, 10 pulse /s, 33/66ms. Temporary MF with tone on first button input "*"																					
Row 6	Only MF, 82/82ms																					
Row 7	Only MF, 82/160ms																					
Note – Pulse/s — pulses per second. During temporary MF : 82/160ms																						
13	C4	Keyboard line. (see keyboard scheme at figure 3)																				
14	C3																					
15	C2																					
16	C1																					

Table 1 continued

Pin No	Pin letter symbol	Function
17	R4	Keyboard line. (see keyboard scheme at figure 3)
18	R3	
19	R2	
20	R1	
21	FCI	Frequency comparator input. Schmitt flip-flop input for ring frequency determination
22	LED	LED output driver. Output for LED control, blinking in "Program / Mute "state
23	M1	Microphone outputs Differential inputs for microphone (electret type)
24	M2	
25	CS	Input of current shunting control. Given N-channel output with open drain controls outer shunting high capacity transistor for modulation of line voltage and for line shorting during period of pulse number dialing
26	V _{SS}	Negative supply connection
27	LI	Line input. Input is used for power abstraction and (adjusting) of line current
28	RI	Receipt input. Input for signal received

*Note – LD – pulse number dialing;

*MF – frequency number dialing;

*DTMF – two-frequency dialing (often case of frequency dialing)

Function selection (general table)

Function	
Straight memory (single key)	4
Indirect memory (two key)	10
Redialing	yes
LNR key	yes
Insert by LNR pause key	yes
Pause key PS	yes
P/M key or MT	P/M
Tone/Pulse key (T/P)	yes
Temporary MF key "*"	yes
Automatic setup key (A – D)	yes
Volumes keys (VOL, "-/+")	yes
Volume reset by off-hook	yes
Tone ring programming	yes
Pause duration "flash" R3	600m

KEYBOARD CONNECTING

Keyboard connecting is shown at figure 3.

Key closed, $R_{ON\ MAX} = 1\ \text{Ohm}$

Key opened, $R_{OFF\ MIN} = 1\ \text{Ohm}$

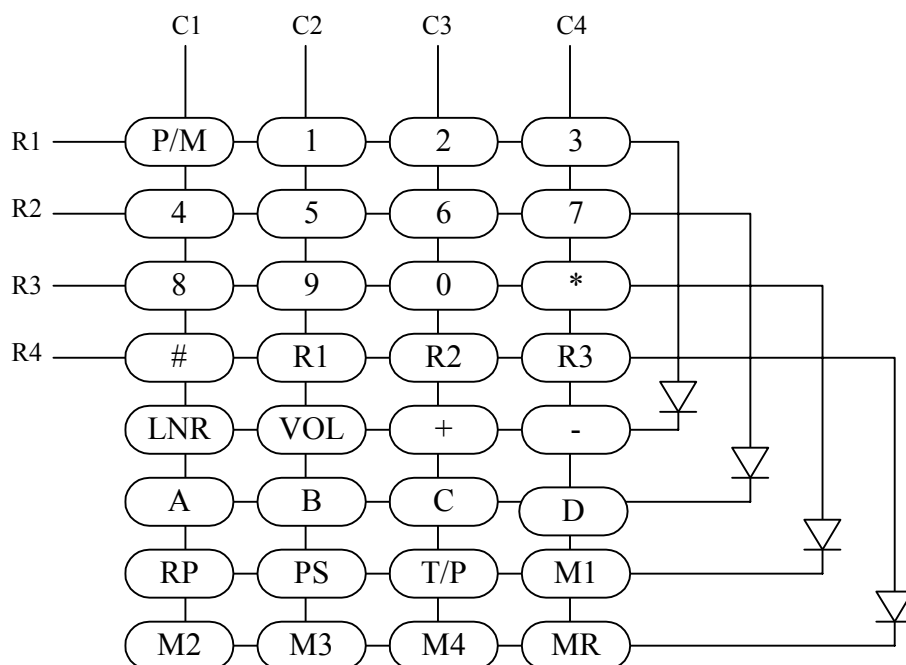


Figure 3 – Keyboard connecting

Power-up set up

On-chip voltage on preset circuit traces supply voltage V_{DD} during receiver off-hook. When V_{DD} increase reaches level approximately 1.2 V, preset circuit empties RAM.

Direct current conditions

Typical operational range is from 13 to 100 mA. Operational range by lowered effectiveness is from 5 to 13 mA (parallel operation). In operational range all functions are active.

By line currents lower than 13 mA microcircuit provides additional decrease lower than 4.5 V in order to allow parallel operation (see fig. 4).

Direct current characteristic (excluding diode bridge) determining by voltage to LI and R1 resistor by line currents higher than 13 mA by following form:

$$V_{LS} = V_{LI} + I_{LINE} \times R1$$

(1). Voltage at LI is 4.5 V in typical operational range. In dialing mode, speech scheme and inactive device parts is in mode of decreased power consumption with the purpose of current saving. CS output pulls up to V_{SS} in order to connect outer shunting transistor for supporting of low voltage at LS output within periods forming.

IMPEDANCE FOR ALTERNATING CURRENT

Circuit impedance on alternating current is adjusting by outer components. Impedance can be actual and complex. Alternating-current resistance Z_{AC} , Ohm, is determining according to following form

$$Z_{AC} = 33 \times Z_1$$

(2) Z_1 direct current value should be 30 Ohm for maintaining of correct characteristics on direct current.

Reverse damping and suppressing of side current can be set up not depending of each other.

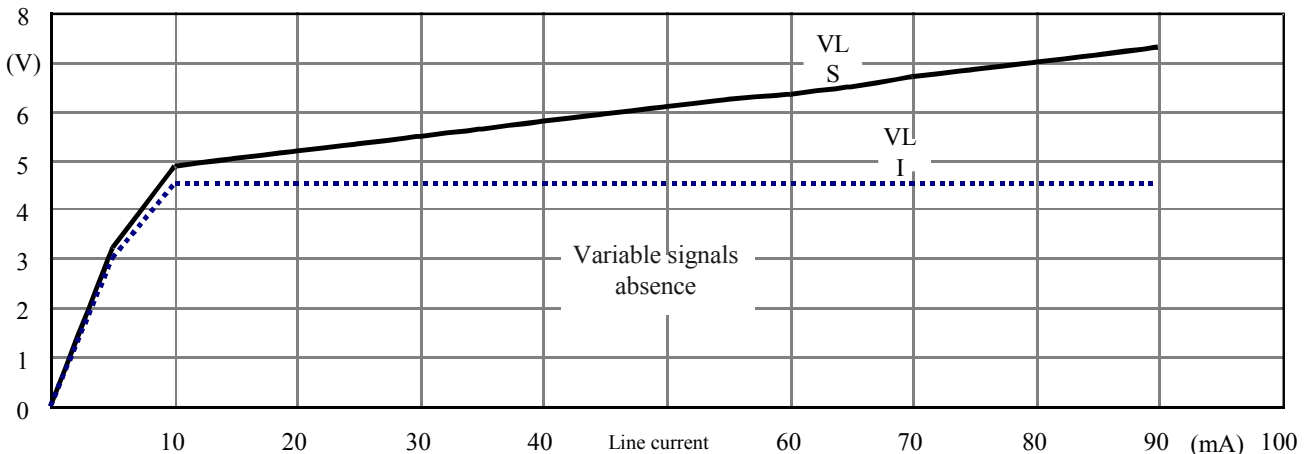


Figure 4 – Direct current characteristics. Dependence of potentials at LI and LS outputs from line current

SPEECH CIRCUIT

Speech circuit consists of transmitting and receiving chains with double soft limitation, line attenuation compensation and side current suppression.

TRANSMITTING

Amplification of transmitting chain is 37 dB for matched load line 600 Ohm from M1/M2 to LS (see test circuit at figure 5). Microphone input is differential input with input resistance 20 kOhm.

Soft limitation circuit limits output voltage at LI to 2 V_{PEAK} (see figure 5). Increase front duration is 30mcs/6dB and decay front duration is 20mcs/6dB. When no-signal mode is active, during dialing or after P/M key pressing, amplification coefficient is reducing by more than 60 dB.

RECEIVING

Amplification coefficient of receiving circuit is 3 dB for 600 Ohm of line load (test circuit at figure 5). Differential-mode signal RI and STB are receiving input. When no-signal mode is active during dialing, amplification coefficient decreases for more than 60 dB. During DIMF dialing, supporting tone is applied to the receiver. DIMF signal is supporting tone, with level lower than minus 30 dB relative to line signal.

Pressing Volume key can change receiving amplification coefficient. VOL key gives raising 5.4 dB and has two-state function, i.e. repetitive key pressing sets up initial value of amplification coefficient. As alternative can be used “+/-” keys. “+”key increases coefficient by 8.1 dB in 3 levels, and “-” key decreases by 5.4 dB in 2 levels (general range 13.5 dB). Volume is set to initial value by switch hook actuation.

Soft limitation circuit adjust voltage at receipt output (RO) no more than $1V_{PEAK}$ (see figure 6) It prevents from sharp distortion and acoustic impact.

SIDE TONE

Good side tone suppression can be reached by using of following equal

$$\frac{Z_{\text{BAL}}}{Z_{\text{LINE}}} = \frac{Z_2}{Z_1} \quad (3).$$

Signal of side tone suppression is applied to STB input (see figure 8).

LINE ATTENUATION COMPENSATION

Line attenuation compensation is controlled by circuit output. When this mode is activated, transmission and receipt coefficient is decreasing by 6 dB by line currents from 20 to 50 mA, when $LLC = A_{\text{GND}}$, and by currents from 45 to 75 mA, when LLC corresponds to high state (@R1=30 Ohm). Line attenuation compensation become disconnected, when LLC corresponds to low state (see figure 7).

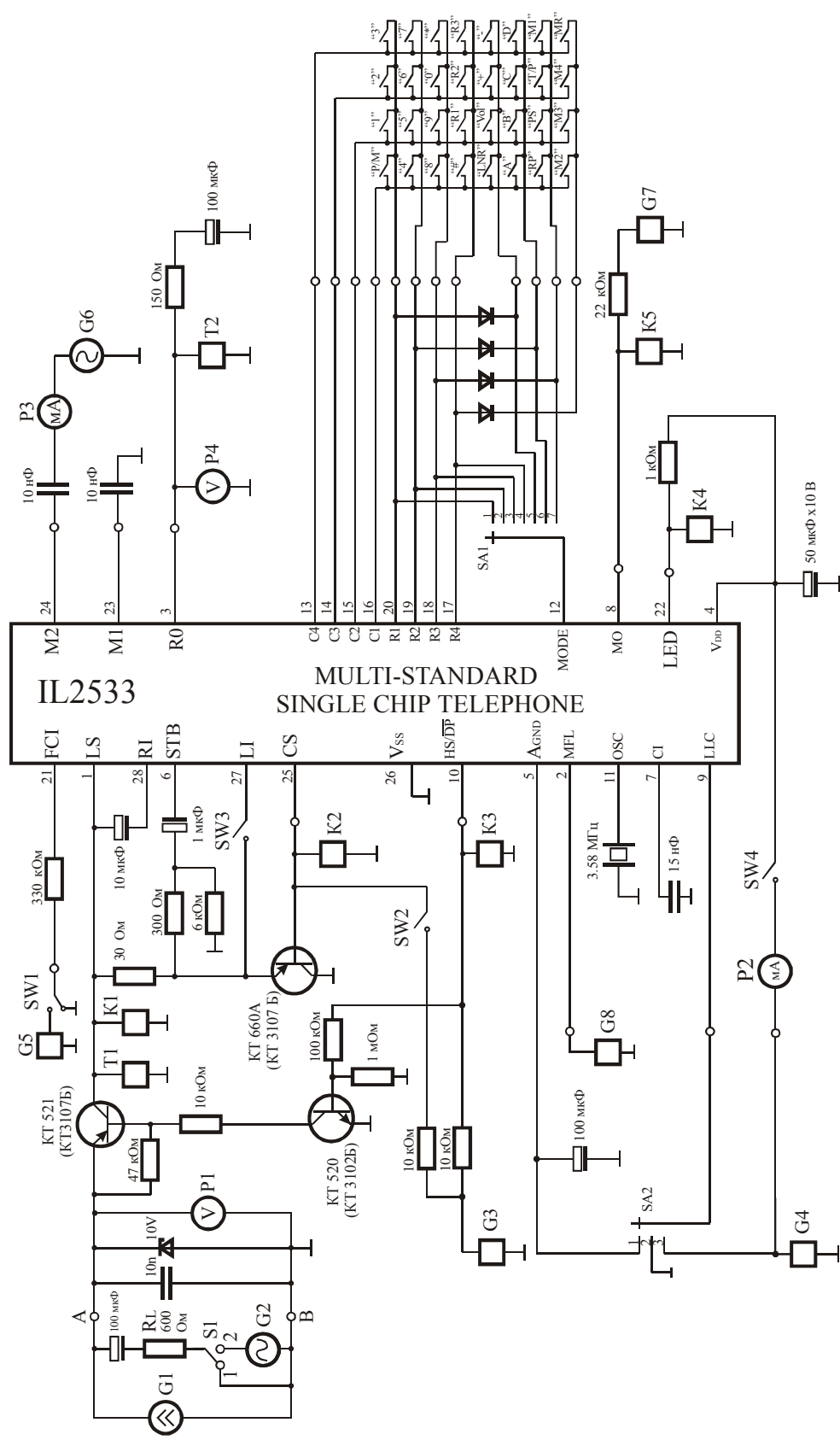
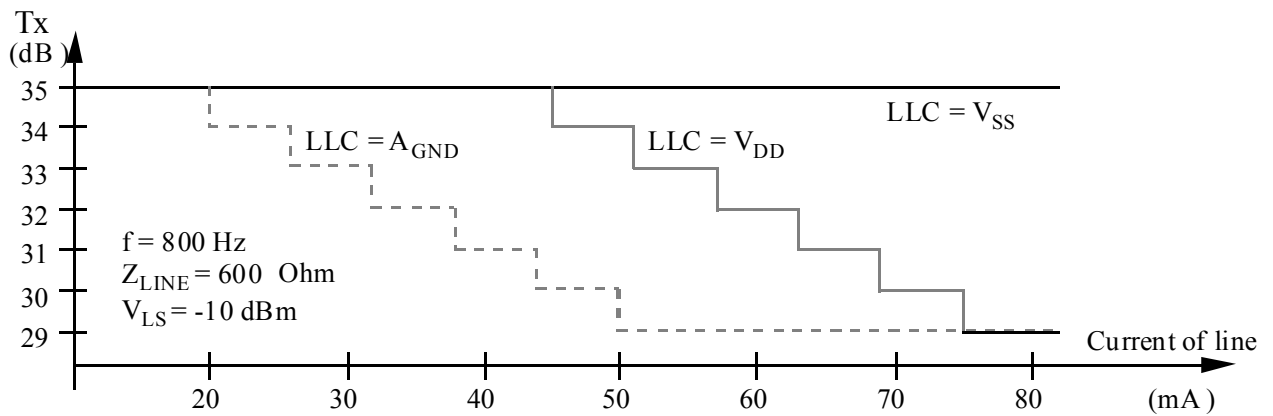
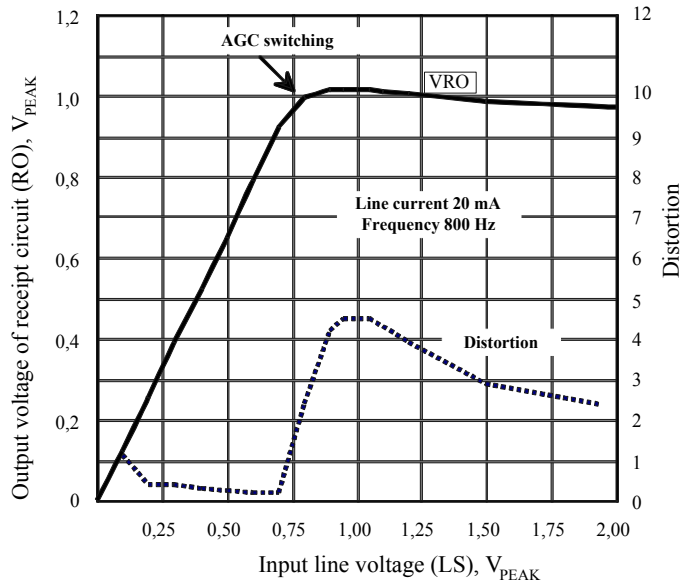
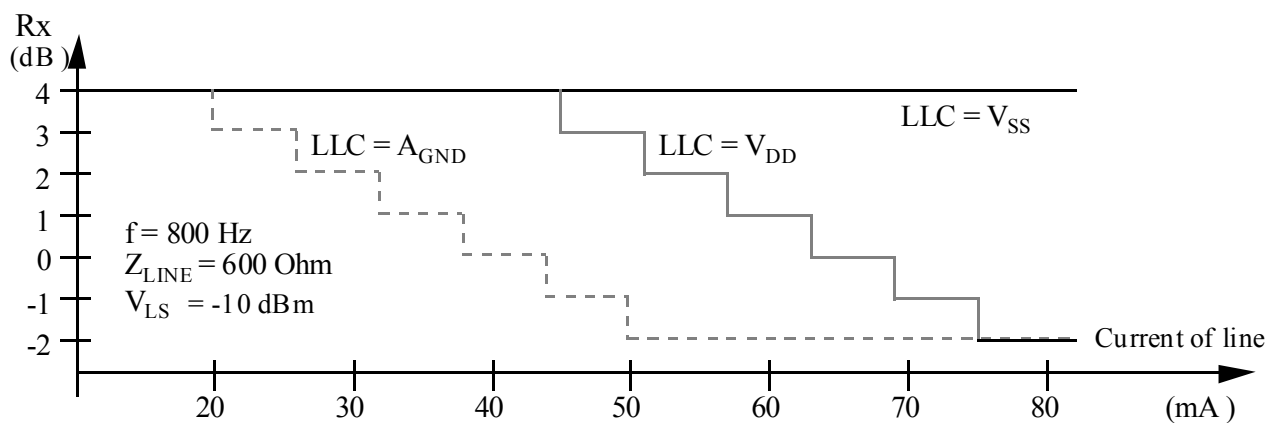


Figure 6 – Soft limitation and distortion by receipt



Typical characteristics and line attenuation compensation for transmitting circuit



Typical characteristics and line attenuation compensation for receiving circuit

Figure 7 – Typical characteristics and line attenuation compensation

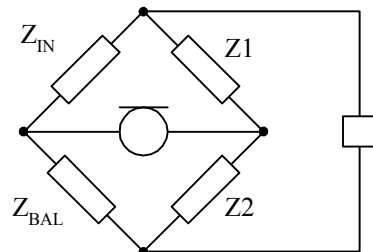


Figure 8 – Side Tone Balance

DIALING FUNCTION

DIGITAL KEYS

Key scanning is allowed, when HS/DPN is set up as high and V_{DD} is higher than V_{REF} . A valid key is detected from the keyboard by connecting the appropriate row to the column ($R_{ON} < 1 \text{ k}\Omega$). It can be done using keyboard matrix $N \times M$ with single contacts. Four diodes are used for lines quantity extension (see keyboard connecting at figure 3.). Also it is possible to connect microcontroller to lines and columns.

P/M KEY

P/M key is used for entry into the program/no-signal state. Pressing P/M key disconnects speech circuit and device is set to program state. Repetitive pressing of P/M key disconnects no-signal mode and program state (function with two states).

When program/no-signal state is activated, light-emitting indication is connected (flash: 80ms "ON" and 1s "OFF.").

SELECTING OF DIALING MODE

Initial mode (LD or MF) can be chosen by output mode.

LD is default selection, time transfer to invoke by pressing T/P key or MF mode can be invoke by pressing T/P key or "*" key (when mode input = line 5, by first pressing of "*" key, MF tone generating). Circuit will revert to initial LD state after pressing of T/P key or after pressing of R (R1, R2 or R3) key or after switch arm actuation.

When MF mode is selected by output mode, circuit can not be switched to LD and will stay in MF mode.

AUTOMATIC SET UP KEY

Letter keys allow to use easily services of interconnections automatic setup. Keys A, B, C or D are available only in MF mode (including temporal MF) and are not saved. Pressing of one of these keys will invoke transferring of corresponding MF.

Automatic set up keys are not saved to RAM, but sequentially entered signs are accumulated into FIFO buffer.

Redialing of the last number (LNR) – is a possibility, that allows to transfer repetitive last hand-dialed number, without pressing the same keys. LNR can be repeated after every receiver put up. Current RAM contents is overwritten by newly entered data.

Hand-entered number is automatically save to LNR RAM. RAM storage capacity is 31 digit. If dialed number is larger than 31 digit, LNR possibility will be blocked (until new data will be less than 31 digit) and further entered data will be buffered to FIFO.

By PS key pressing, pauses can be put out.

Digits, dialed later, i.e. digits entered by hand after LNR invocation, are not stored to RAM, but buffered to FIFO.

REDIALING

The last hand-dialed number can be redial without lever pressing, with the help of RP key. If dialed number is busy, than pressing of RP key interrupts line for 1.6 c (in order to pass to new dialing) and after pause number will be repeated.

Redialing function is allowed, if number was dialed before pressing RP key. It can be called unlimited times till next pressing of the lever. During 1.6-second interval, device is in lower energy consumption mode for current saving.

REPEATED CALL FUNCTION

Repeated call activation (R1, R2 or R3 keys) will cause flash (with periodic intervals), at that R1 flashes are never accomplished in LD mode. R2 and R3 will be implemented independently of mode.

If repeated call is repeated record in digit line, it will be stored into LNR RAM, when digit (digits) are entered after repeated call.

If redial key is pressed after entering of digit line into FIFO buffer with sequentially entered digit.

If redial key pressing does not accompanying by digits entering, LNR RAM stays untouched.

After number redialing, pause with duration 270 ms will be accomplished.

Keys from M1 to M12 are keys of direct memory access, and MR key is used for abbreviated dialing.

Table 2

Memory structure	Quantity of numbers or keys
Number storing	14
Keys of direct memory access	4
Indirect memory	10

Numbers can be stored to on-chip RAM. Every number can contain upto 21 digit (including pauses).

During programming several pauses can be entered by PS or LNR keys pressing. Every pause, inserted within first 5 entries will be automatically limited after 2 seconds, while pauses, inserted after position 5 in the digit line will stop dialing that can be continued after PS or LNR keys pressing. "Stop" function allows dialing in PABX extension.

Example – 45678–123 is stored in M1, where "-" is pause/waiting, and 123 is extension number:

- 1) Lift up the receiver. Wait for tone signal;
- 2) Press M1 (45678 will be dialed);
- 3) Wait for tone signal from called PABX;
- 4) Press PS or LNR (123 will be dialed).

Dialing from the memory is cascade. However, one memory cell contents shall be dialed before new one can be invoked.

PABX – PAX with outcoming and incoming communication.

FLOATING MARKER METHOD

In order to accomplish simple LNR dialing after connection with Automatic telephone system Protocol of floating marker is used. If new entry coincides with contained in RAM, LNR key pressing will cause automatic dialing of rest digits.

If there is inequality in coincidence, than LNR blocked till next lever pressing, and RAM will contain new number.

Example – (LNR912345 contents, where 9 is access code):

- 1) Lift up the receiverснять, wait for Automatic telephone system dial tone;
- 2) press 9 and wait for outer dial tone;
- 3) Press LNR (12345 will be dialed).

STONE OSCILLATOR

Tone oscillator includes DTMF tones, three main frequencies for tone ring and quieting DTMF tones. DTMF oscillator provides 8 frequencies, namely:

Lower Group:

- Sig 1 - 2 - 3 - A 697 Hz
- ns
- Sig 4 - 5 - 6 - B 770 Hz
- ns
- Sig 7 - 8 - 9 - 852 Hz
- ns C
- Sig * - 0 - # - D 941 Hz
- ns

Upper Group

- Sig 1 - 4 - 7 - * 1209 Hz
- ns
- Sig 2 - 5 - 8 - 0 1336 Hz
- ns
- Sig 3 - 6 - 9 - # 1477 Hz
- ns
- Sig A – B - C – 1633 Hz
- ns D

The output level of MF can be set by means of the external divider to the pin MFL.

Voltage at Pin MFL (2)	DTMF Level (Lower Group)
1.50 B (A _{GND})	-4.0 dBm
1.27 B	-5.2 dBm
1.15 B	-6.4 dBm
1.03 B	-7.6 dBm
0.90 B	-8.8 dBm
0.70 B	-10.0 dBm
0.54 B	-11.2 dBm
0.42 B	-12.4 dBm
0.30 B	-13.6 dBm
0.18 B	-14.8 dBm
0.00 B (V _{SS})	-16.0 dBm

(Z_{LINE} = 600 Ohm)

The preliminary distortion constitutes 2.6 dB. MF tones comply with the recommendations of CEPT.

Tone Ring (MELODY / LOUDNESS)

The three main parts for the melodies are as follows: F1 = 800 Hz, F2 = 1067 Hz and F3 = 1333 Hz ($\pm 5\%$).

Frequency of repetition and loudness of the tone melody rings can be programmed by pressing P/M and #, indicated with a sign in compliance with Table 4.

Table 4

SIG N	FREQUENCY OF REPETITION	LOUDNESS
1	1 time (50 msec pause)	-16 dB
2	1 time (50 msec pause)	- 7 dB
3	1 time (50 msec pause)	0 dB (max)
4	4 times	-16 dB
5	4 times	- 7 dB
6	4 times (by default)	0 dB (max)
7	10 times	-16 dB
8	10 times	- 7 dB
9	10 times	0 dB (max)
0	None	OFF

The procedure is completed by the repetitious pressing of the key P/M.

The default setting complies with the figure 6, i.e. after the supply ON preset the device will be started with the repetition rate of 4 and the maximum loudness. If the sign 0 is programmed, then the tone ring will be disabled until the next receiver lift, when it is set for the last preset value, previous to zero. The programmed preset values are stored in RAM on the chip.

The repetition frequency signifies, that the sequence from 6 frequencies is repeated 1.4 or 10 times during 1 sec.

The frequency sequence is controlled by means of the sequence register as follows:

Sequence F1 F2 F3 F1 F2 F3

QUIETING TONE

During the MF dialing the number the DIMF tones are applied to the phone speaker as a comforting tone.

In the course of programming entry of the keys is indicated by means of the quieting tone of 1477 Hz. The quieting tone level constitutes approximately 60 mB at the output of RO. Duration constitutes 40 msec. After each key pressing in the program mode.

When the program mode is terminated with the key P/M, the identification tone is applied of 140 msec. An erroneous key pressing shall cause termination of the program mode, indicated by the denial tone 4 times of 40 msec with the pauses of 28 msec between the tone enablings.

IDENTIFICATION OF THE RING FREQUENCY

The ring frequency identification block assumes, that only the signals with the frequencies between 13 and 70 Hz shall be considered as the real ringing signals. The real ringing signal identification time constitutes $1/f$ sec, where f is equal to the ring frequency.

When the real ringing signal is continuously available during 73 msec, the melody generator is activated and remains active as long as the ring signal is available.

As soon as the melody generator is started, the ring signal is continuously monitored, and the melody generator is enabled or disabled instantly in compliance with the short time availability of the correct or erroneous ring signal appropriately (until the next supply enabling or hanging up the receiver).

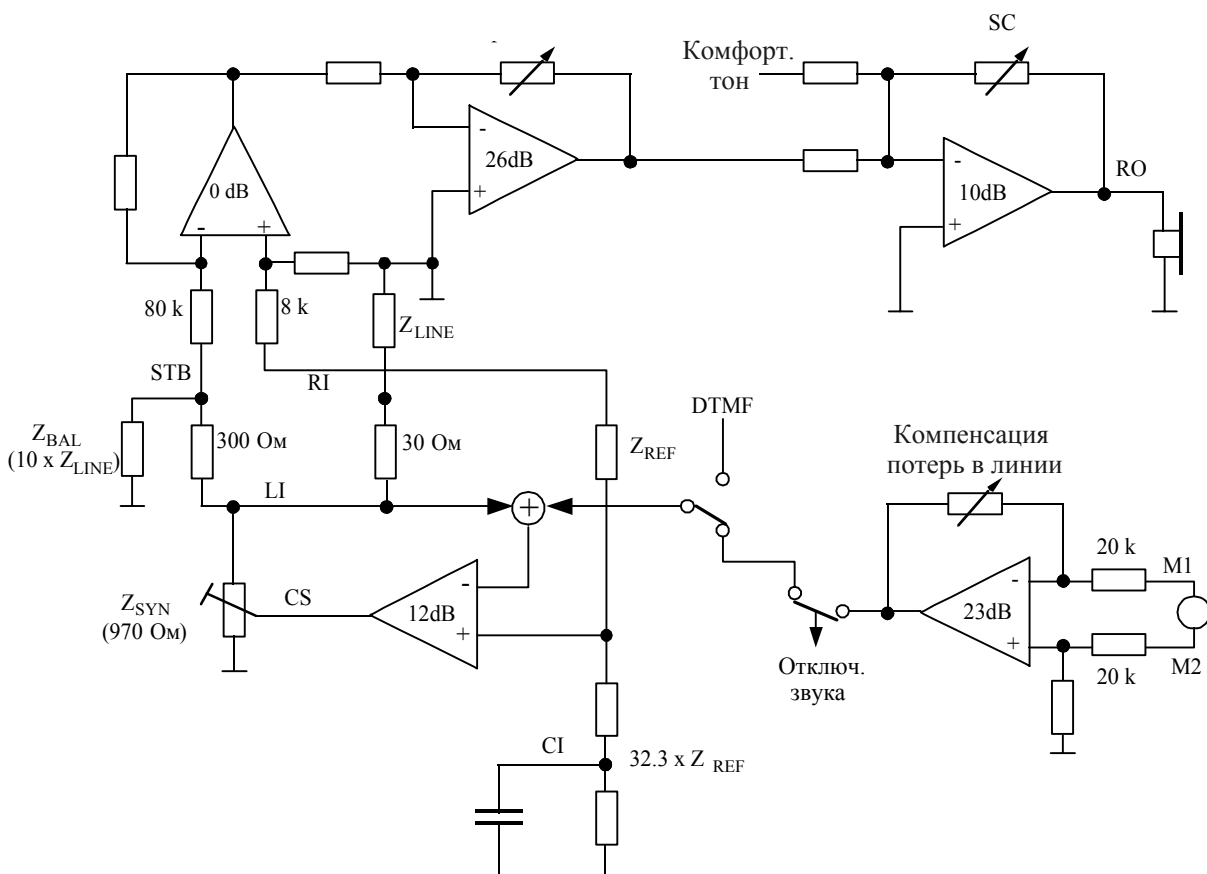


Figure 9 – Speech circuit model by the alternating current

LEGEND






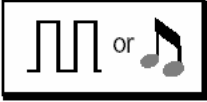


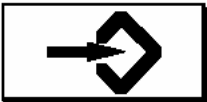






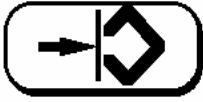

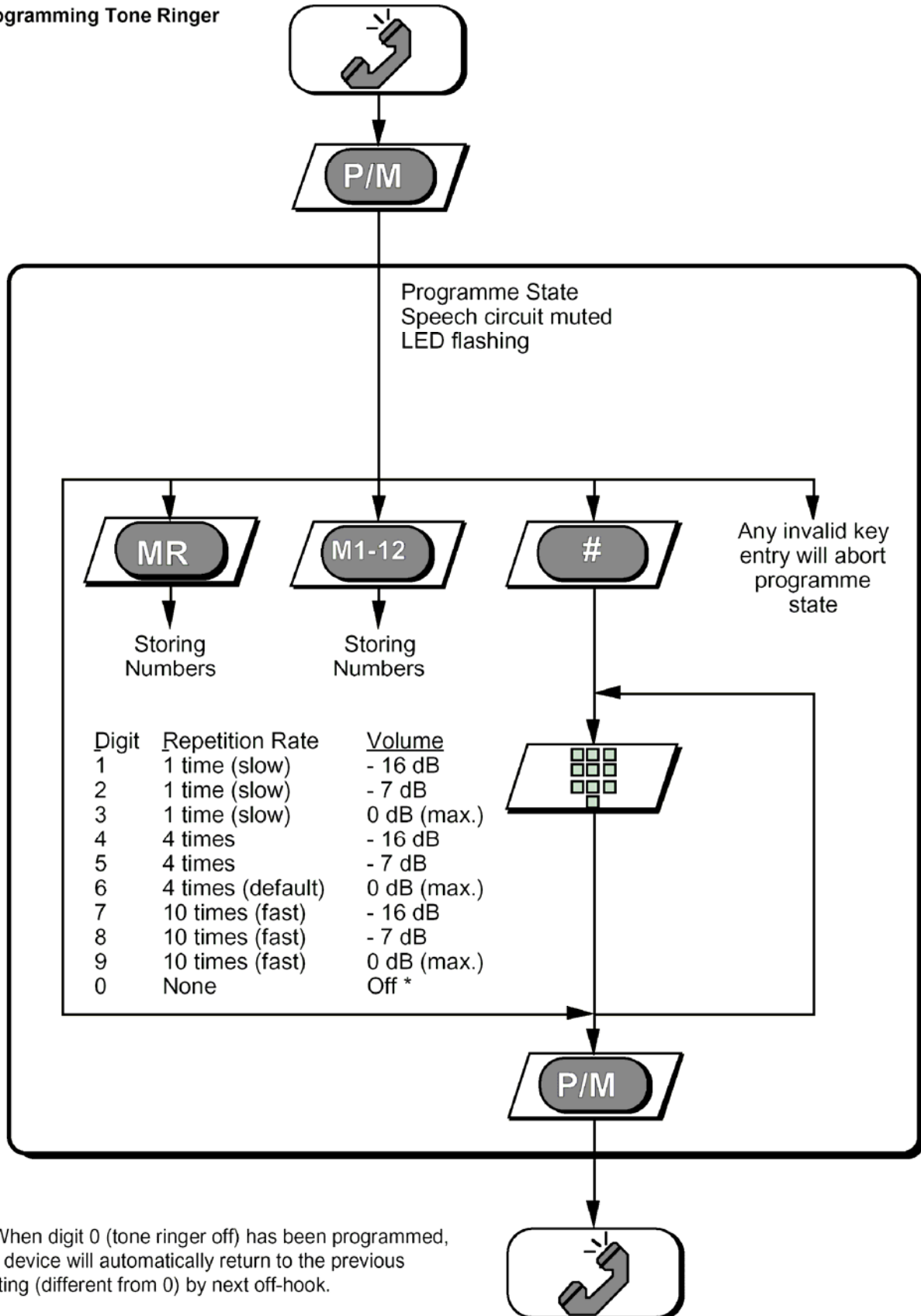
STATUSES		INPUTS		PROCESSING	
	No operation (receiver out. no		Receiver lift-		Forced break (sec)
	Speech mode		Receiver put-		Number dialing (LD
	Cut-off from outsiders		Key pressing		Saving (storing in
	Programming		Number entry		Processing in compliance
	Erroneous program entry		Entry in compliance		Read-out from
	Incorrect entry				
	Status compliance in with				

Figure 10 – Symbols

Programming Tone Ringer



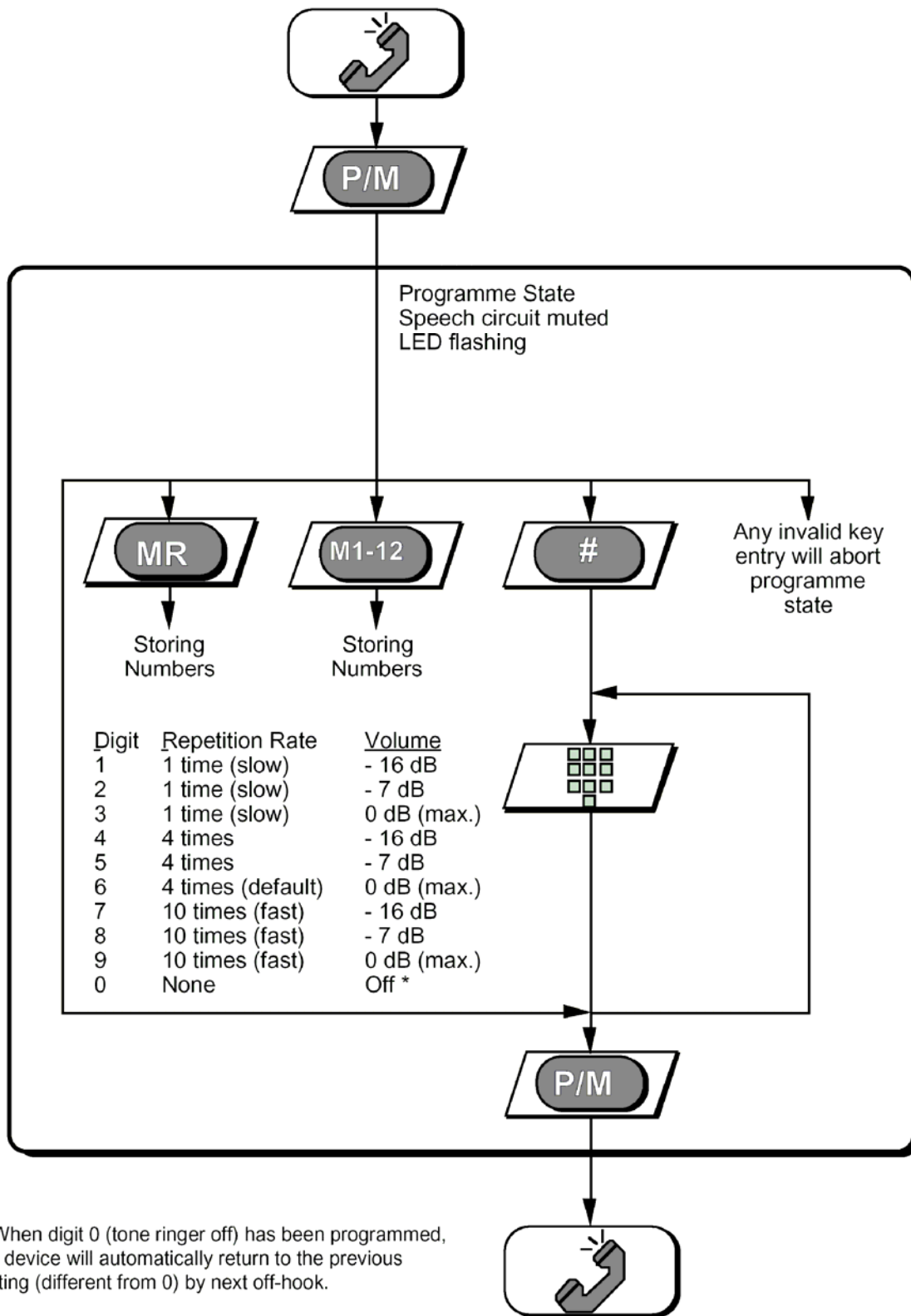


Figure 11 – Ring tone programming

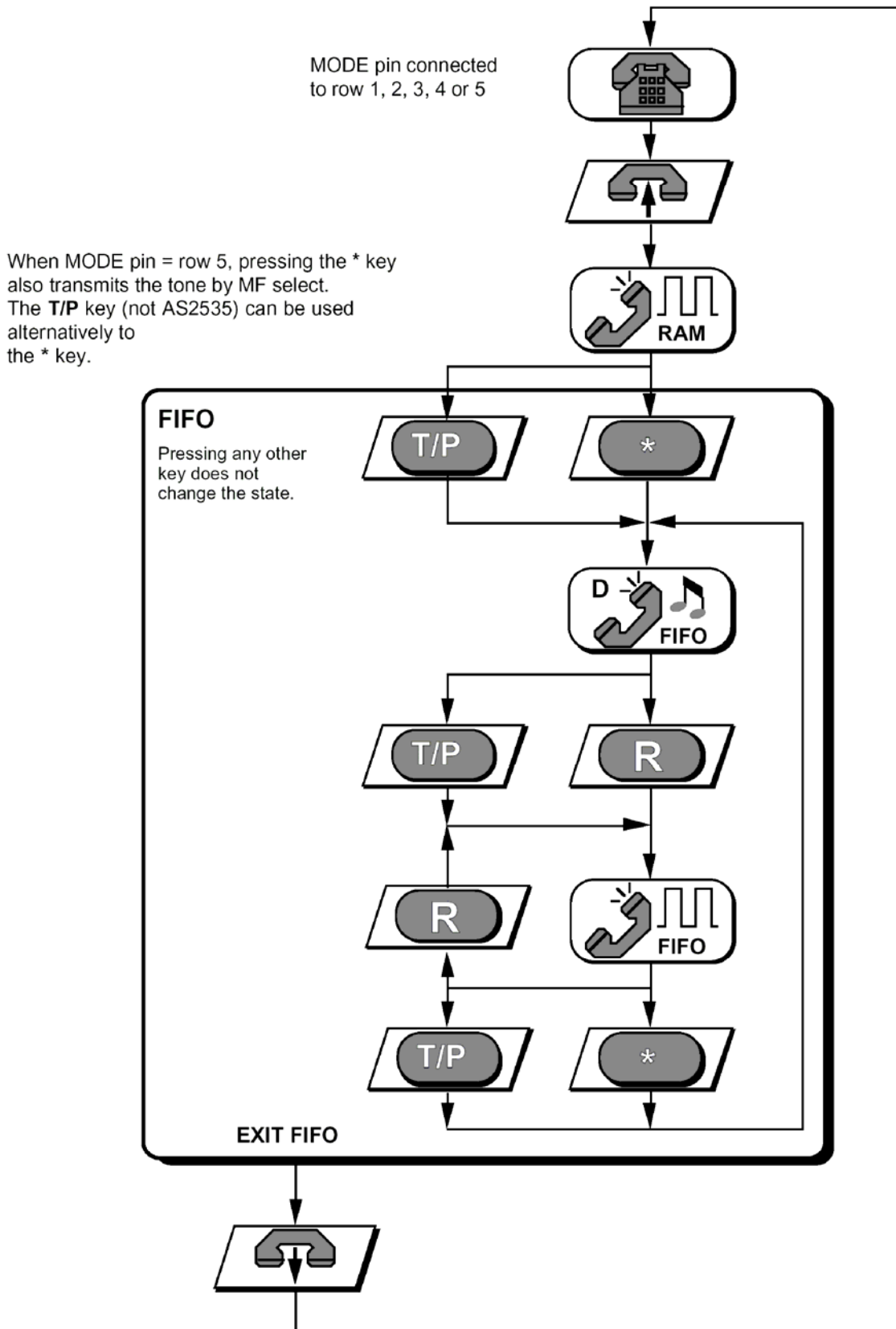


Figure 12 – Time MF

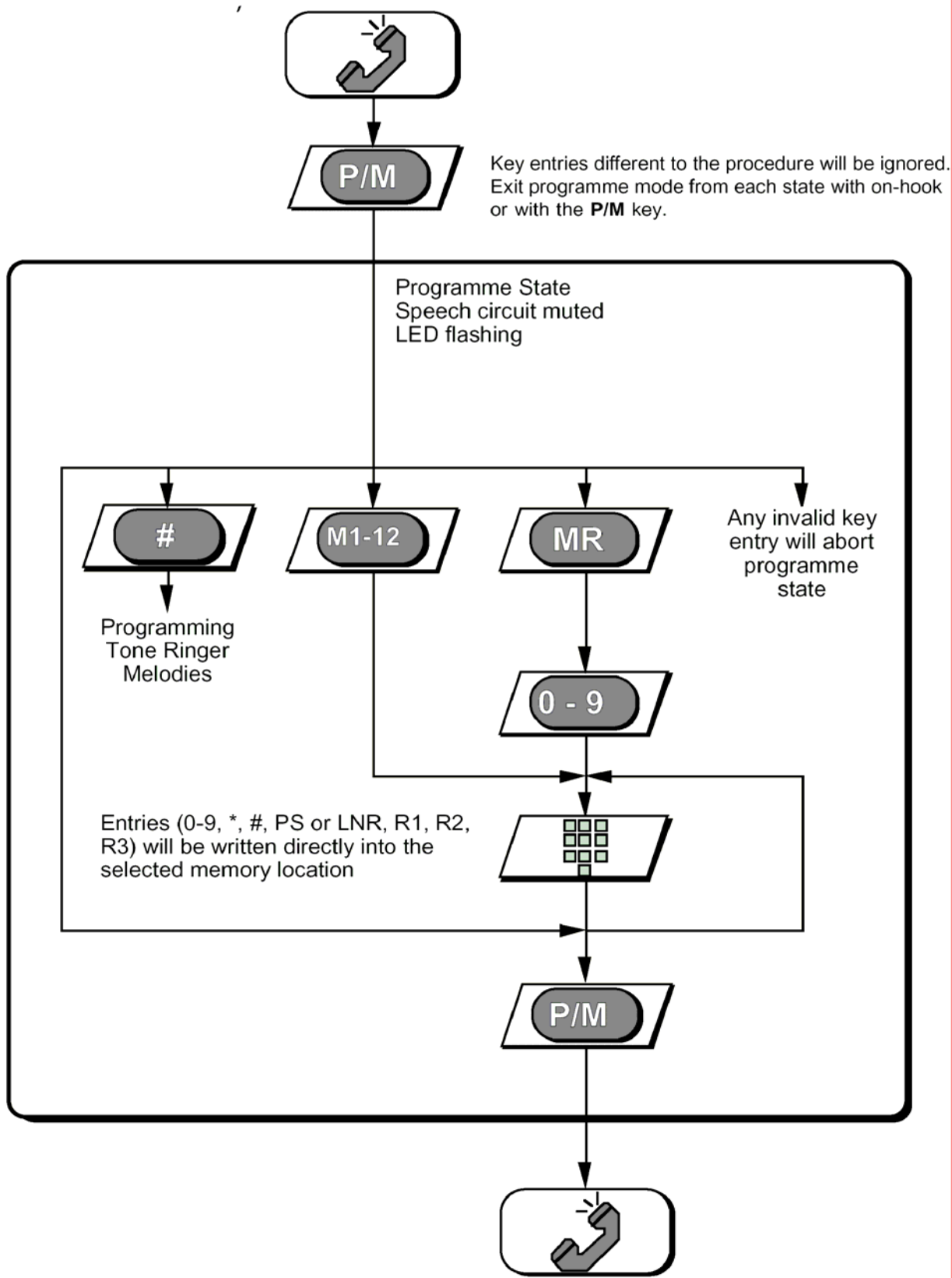
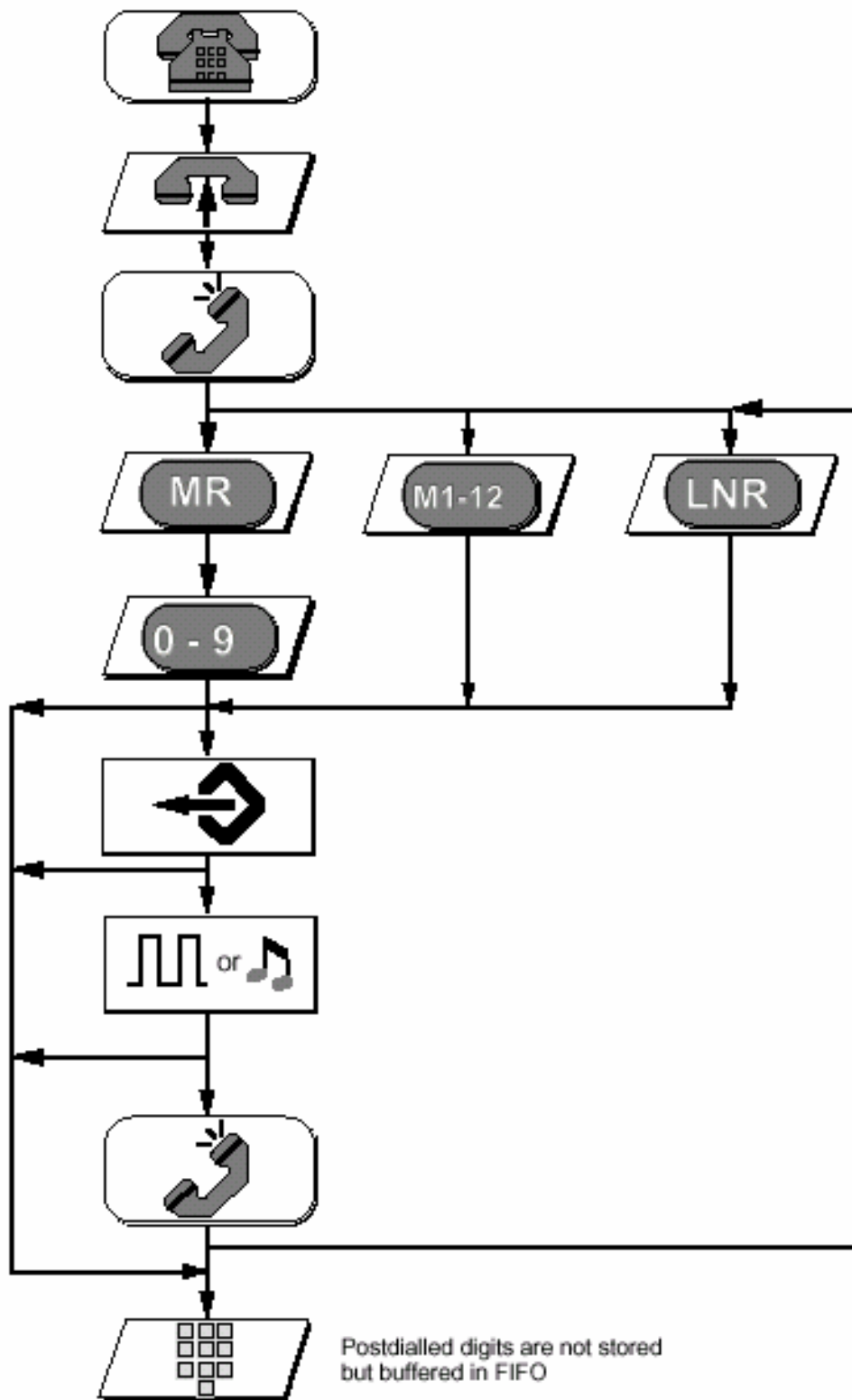


Figure 13 – Storing numbers



Complex impedance (270 Ohm + 750 Ohm // 150 nF)

Figure 14 – Automatic number dialing

Those components are included only, which are required for representing the complete functions of the microcircuits.

The external components can be altered for compliance with the requirements of the various national standards and for matching the various converters.

As a microcircuit is a component, but not a complete system, it cannot be applied as a separately positioned individual element on the standard basis. Consequently, the complete compliance with any standards depends upon application, where a microcircuit is used, and therefore selection of the standard application is the responsibility prerequisite of the Customer, and the manufacturer does not check the device for compliance with the concrete standards.

- 1 Line adaptation.
Power selection.
D. C. masking.
- 2 Line current read-out.
- 3 Soft limitation Мягкое ограничение of the automatic gain control.
- 4 Melody sequence setting block.
- 5 Ring frequency limitation.
- 6 Control logic.
- 7 Current generator.
- 8 Oscilloscope.
- 9 RAM. Melody.
Automatic number dialer.
- 10 Keyboard.

METHOD OF OPERATION

PRINCIPLES OF OPERATION

Methods of the microcircuit potentialities application are optimized in such a way, so as:

- to comply with the expectations of the user;
- to be easy for training and upgradation;
- not to cause any automatic functions, which are not expected by the user
- to protect the user from making the critical errors, i.e. from dialing incorrect numbers, deletion of the stored numbers, etc.;
- to be matching, simple and convenient in operation.

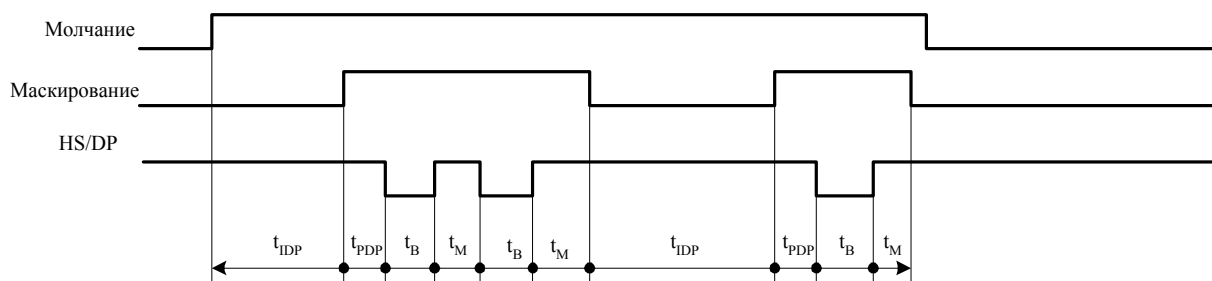


Figure 15 – Time chart of the number dialing

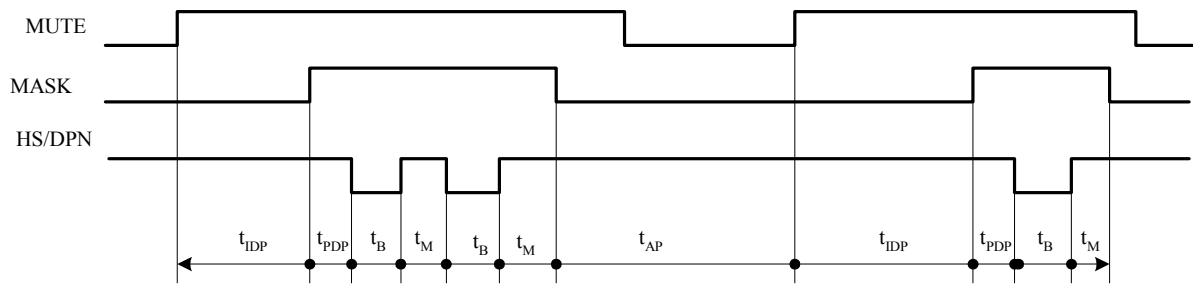


Figure 16 – Time chart of the LD number dialing with the access pause

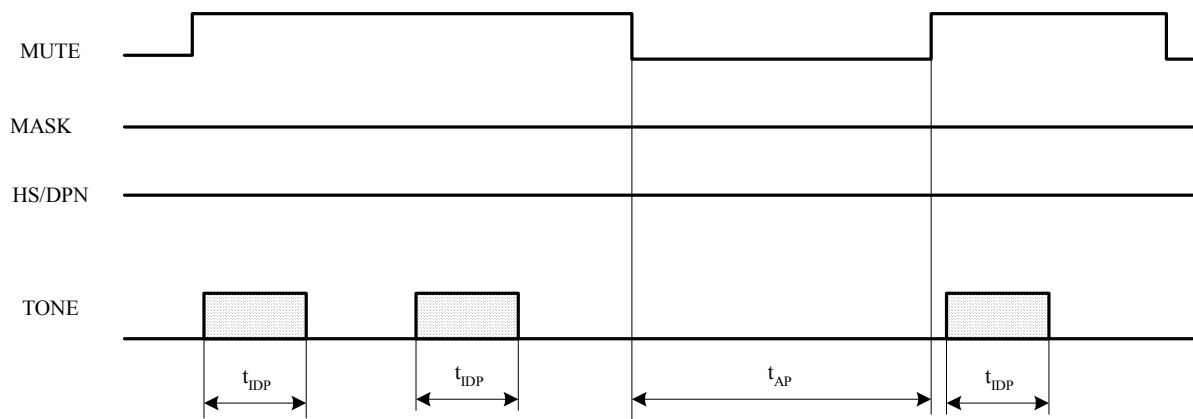


Figure 17 – Time chart of the MF number dialing

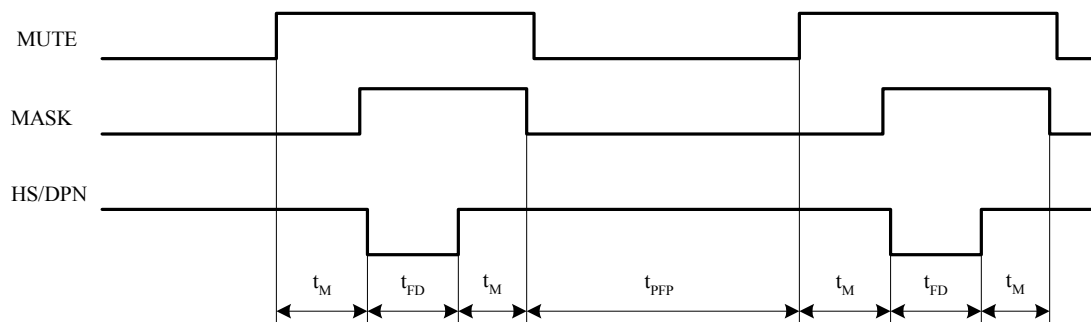


Figure 18 – Flashing time chart

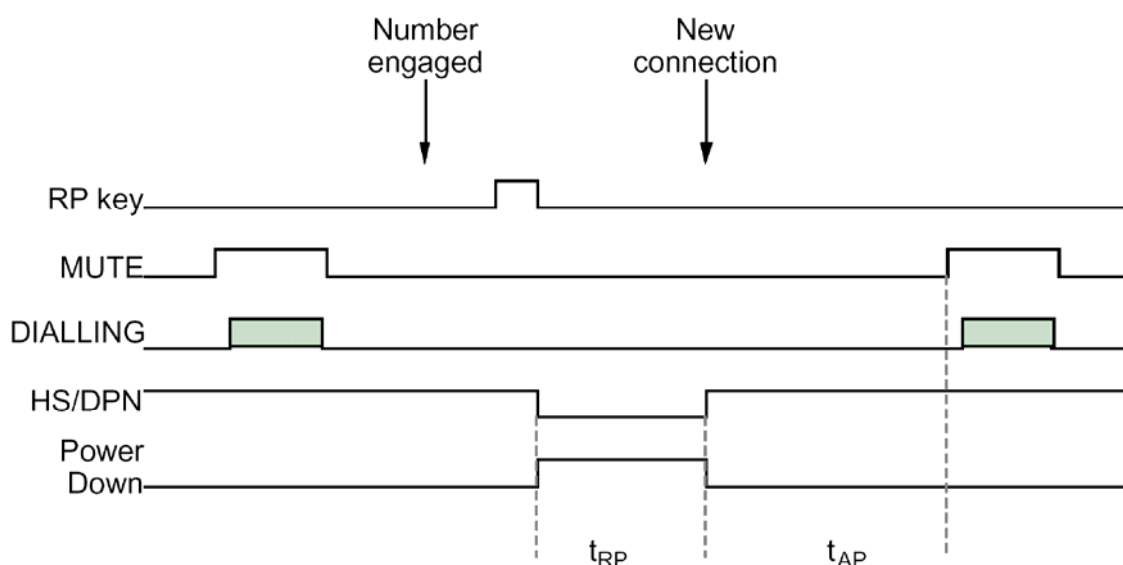


Figure 19 – Time chart of the number redialing

Table 5 – ELECTRIC CHARACTERISTICS

($V_{DD} = (4.5 \pm 0.5) V$; $I_{LINE} = 15 mA$; $f = 800 Hz$; $T_a = (-25; +70) ^\circ C$, if otherwise not stated below)

Description of Parameter, Unit of Measurement	Parameter Letter Identification	Mode	Norm		Remark
			Not less	Not more	
Consumption current, mA	I_{DD1}	Speech mode	-	5	-
	I_{DD2}	MF dialing ¹⁾		8.0	
	I_{DD3}	LD dialing ²⁾ . $V_{DD}=2.5 V$		400	
	I_{DD4}	Ring mode. $V_{DD}=2.5 V$		600	
Storage current, mcA	I_{DD0}	Standby mode. $V_{DD} = 2 V$; $T_a = 25 ^\circ C$		0.1	
Low level output current, mA	by output CS $I_{OL(CS)}$	$V_{OL} = 0.4 V$	1.5	-	
	by output HS/DP $I_{OL(HS/DP)}$		1.5		
	by output MO $I_{OL(MO)}$		1.5		
	by output LED $I_{OL(LED)}$		4.0		
Line voltage (by preset default value), V	V_{LI}	$13 mA \leq I_L \leq 100 mA$	4.0	5.0	
Transfer (Tx)					
Transfer gain coefficient, dB	A_{TX}	M1, M2 relative to LI	35.1	38.1	
Alteration of gain coefficient depending on frequency, dB	$\Delta A_{TX/F}$	M1, M2 relative to LI. $f = (500 - 3400) Hz$	-0.8	0.8	
Distortion coefficient, %	THD_1	$V_{LI} \leq 0.25V_{RMS}$ ³⁾	-	2	
Soft limitation level, V	V_{AGC1}	Speech mode	$1.6V_{PEAK}$ ⁴⁾	$2.4V_{PEAK}$	
Soft limitation overload, dB	A_{SCO}	-	15	25	
Input signal rise time, mcsec/6dB	t_{ATTACK}	-	22.5	37.5	
Input signal fall time, msec/6dB	t_{DECAY}	-	15	25	
Input impedance, kOhm, By inputs M1, M2	Z_{IN}		15	25	
Attenuation during silence, dB	A_{MUTE}	Silence mode	60	-	
Output noise voltage, dBm	V_{NO1}	$T_a = 25 ^\circ C$	-	- 72	
Input voltage range, V, by inputs M1, M2	$V_{IN MAX1}$	Differential	$0.75V_{PEAK}$	$1.25V_{PEAK}$	-
		Single-sided	$0.375V_{PEAK}$	$0.625V_{PEAK}$	

Table 5 Continued

Description of Parameter, Unit of Measurement	Parameter Letter Identification	Mode	Norm		Remark
			min	max	
Output Driver (BJT)					
Input voltage range, V, by input LI	$V_{IN\ MAX2}$	–	$-2V_{PEAK}$	$2V_{PEAK}$	
Dynamic range, V	V_{TX}	–	$1.5V_{PEAK}$	$2.5V_{PEAK}$	
Reflection attenuation, dB	RL	$Z_{RL} = 1000\ \Omega,$ $T_a = 25\ ^\circ C$	18	–	
Attenuation alteration from temperature, Ohm/ $^\circ C$	$\Delta Z_{AC/TEMP}$	–	0.375	0.675	
Reception (Rx)					
Reception gain coefficient (by default), dB	A_{RX0}	LI relative to RO	1.5	4.5	
Loudness gain coefficient, dB	A_{VOL1}	Key VOL	4.4	6.4	
Loudness gain coefficient, dB	A_{VOL2}	(-/+) keys	7.1	9.1	
Alteration of the gain coefficient from the input frequency, dB	$\Delta A_{RX/F}$	f from 500 to 3400 Hz	-1.5	1.5	
Distortion coefficient, %	THD ₂	Speech mode. $V_{RI} \leq 0.25 V_{RMS}$	–	2	
Soft limitation level, V	V_{AGC2}	Speech mode	$0.8V_{PEAK}$	$1.2V_{PEAK}$	
Soft limitation overload, dB	A_{SCO}	Speech mode	–	10	
Input signal rise time, mcsec/6dB	t_{ATTACK}	$V_{RI} > 0.8 V_{RMS}$	22.5	37.5	
Input signal fall time, msec/6dB	t_{DECAY}	–	15	25	
Noise output voltage, dBm ⁵⁾	V_{NO2}	Speech mode. $T_a = 25\ ^\circ C$	–	-72	
Undesirable frequency components, dBm	V_{UFC}	from 50 to 20 kHz		-60	
Input impedance, kOhm, by input RI	$Z_{IN\ RI}$	Speech mode	7.5	8.5	
Input voltage range, V, by input RI	$V_{IN\ RI}$	Speech mode	$-2V_{PEAK}$	$2V_{PEAK}$	
Side tone suppression, dB	A_{ST}	$V_{RI} \leq 0.25 V_{RMS}$	26	–	
Input voltage range, V, by input STB	V_{INST}	Speech mode	$-2V_{PEAK}$	$2V_{PEAK}$	
Input impedance, kOhm, by input STB	$Z_{IN\ STB}$	Speech mode	75	85	
DTMF⁶⁾ Mode					
Frequency deviation, %	F		–	1.2	1
MF tone level (lower group), dB	V_{MF1}	MFL = A_{GND}	-2.5	-5.5	–
	V_{MF2}	MFL = V_{SS}	-14.5	-17.5	
Fore-distortion from the low level to high level, dB	ΔV_{L-H}	–	1.8	3.0	
Undesirable frequency components, dBm MFL = V_{SS}	V_{UFC1}	f from 300 Hz to 5 kHz	–	-40	2
	V_{UFC2}	f from 5 to 14 kHz		-50	
	V_{UFC3}	f from 14 to 28.5 kHz		-70	
	V_{UFC4}	f from 28.5 to 40 kHz		-80	
Tone duration, msec	t_{TD}	Mode: line 6 or 7	80	85	3, 4
Intertone pause, msec	t_{TP1}	Mode: line 6	80	85	3
	t_{TP2}	Mode: line 7	150	170	3, 4
Tone rise time, msec	t_{TR}		–	5	5
Tone fall time, msec	t_{TF}				
Keyboard					
Wobble elimination time, msec	td		13.5	16.5	
Input HS/DP					
Wobble elimination during transfer from low status to high status, msec	t_{HS-L}	Receiver lift-up	13.5	16.5	
Wobble elimination during transfer from high status to low status, msec	t_{HS-H1}	No LD number dialing	200	220	
LD mode					
Number dialing rate, pulse/sec	t_{DR1}	Mode: line 1, 2 or 5	9.53	10.5	
	t_{DR2}	Mode: line 3 or 4	19.05	21	
Pulse duration, msec	t/B_1	Mode: line 2	57	63	
	t/B_2	Mode: line 4	28.5	31.5	
	t/B_3	Mode: line 1 or 5	63	69	
	t/B_4	Mode: line 3	31.5	34.5	

Table 5 Continued

Description of Parameter, Unit of Measurement	Parameter Letter Identification	Mode	Norm		Remark
			min	max	
Duration of interpulse pause, msec	t _{HS-H2}	In progress of LD number dialing	260	280	
	t _{M1}	Mode: line 2	38	42	
	t _{M2}	Mode: line 4	19	21	
	t _{M3}	Mode: line 1 or 5	31.5	34.5	
	t _{M4}	Mode: line 3	15.7	17.3	
Fore-digit pause, msec	t _{PDP}	LD dialing. Alternately buttons 2, 1 are pressed	31.5	38.5	
Internal sign pause, msec	t _{IDP}	Mode: line 1, 2, 3, 4 or 5	800	880	
Flash duration, msec	t _{FD1}	Key R1	100	102	
	t _{FD2}	Key R2	270	300	
	t _{FD3}	Key R3	600	650	
Duration of entry pause, msec	t _{AP}	–	2.0	2.12	6
Time of repeat line interruption, sec	t _{RP}	LD dialing. RP button pressing	1.5	1.7	–
Tone Ring					
Melody output, V	V _{MO}	Ring mode	–	–	
Melody delay, mc	t _{MO}		–	10	
Ring frequency, Hz	f ₁		760	840	
	f ₂		1015	1120	
	f ₃	1260	1400		
Call signal detection time, msec	t _{DT}		–	150	
Minimum detectable frequency, Hz	f _{MIN}	Ring mode	–	13	–
Maximum detectable frequency, Hz	f _{MAX}		70	–	
Quieting Tone. Program Mode					
Tone frequency, Hz	f _{PT}	Programming mode, key entry	1400	1550	–
Voltage level at output RO, mV	V _{RT}	Programming mode	55	65	
Pulse duration while pressing a key, msec	t _{RTD-E}	Key value entry	35	–	
Confirmation pulse duration, msec	t _{RTD-A}	Limited by the key P/M	105	175	
Deviation pulse duration, msec	t _{RTD-R}	Incorrect key entry in the program mode	140	180	
Light Diode Output					
LED enabling time, msec	t _{LED-ON}	Programming mode	80	–	–
Interval, sec	t _{LED-OFF}		1	–	
Comfort Tone (DIMF)					
Voltage level at output RO relative to the voltage level at input LS, dB	V _{CT}		–	-30	
<p>Notes</p> <p>1 It does not enable the frequency deviation of the ceramic resonator</p> <p>2 Relative to the high group</p> <p>3 Values are valid at the time of the automatic number dialing and have the minimum value at the time of the manual number dialing, i.e. the tones will last as long as the key is pressed</p> <p>4 At the time of the temporary MF mode</p> <p>5 Rise time is the time from reaching 10% of the final value till the tone amplitude gets 90% of its final value</p> <p>6 Pauses, entered within the limits of the first 5 entries of the sign chain, shall be automatically limited after 2 sec. Pauses, entered after position 5, can be limited manually only by pressing the key PS or LNR</p> <p>7 Incorrect entry of a key in the program mode shall cause the tone sequence with 4 packs of tones of 40 msec and the pauses between the packs of 28 msec and the forced exit from the program mode</p> <p>1) MF dialing – frequency number dialing</p> <p>2) LD dialing – pulse number dialing</p> <p>3) V_{RMS} – functioning voltage of the sinusoidal signal</p> <p>4) V_{PEAK} – peak (amplitude span) voltage of the sinusoidal signal</p> <p>5) dBm – voltage value, determined by formula $1 \text{ dBm} = 20 \lg V / 0.775 \text{ V} \quad (4)$ where V – voltage, V</p> <p>6) DTMF – dual frequency number dialing (particular case of the frequency dialing)</p>					

Table 6 – Limit Permissible and Limit Modes of Microcircuit Operation

Description of Mode Parameter, Unit of Measurement	Parameter Letter Identification	Limit Mode Permissible		Limit Mode		
		Norm		Norm		
		min	max	min	max	
Supply voltage, V	V_{DD}	4.0	5.0	-0.3	7.0	
Low level input voltage, V	V_{IL}	0	$0.3V_{DD}$	-0.3	$0.3V_{DD}$	
High level input voltage, V	V_{IH}	$0.7V_{DD}$	V_{DD}	$0.7V_{DD}$	$V_{DD}+0.3$	
Input voltage by pin LS, B	V_i	-	-	-0.3	1.0	
				By pin LI, CS	-0.3	8.0
				By pin STB, RI	-2.0	$V_{DD}+0.3$
				By pin MO	-0.3	35.0
Input current, mA	I_i			-25	25	
Frequency, MHz	F	-	3.58	-	3.58	
Storage temperature, °C	T_{STG}	-	-	-65	125	

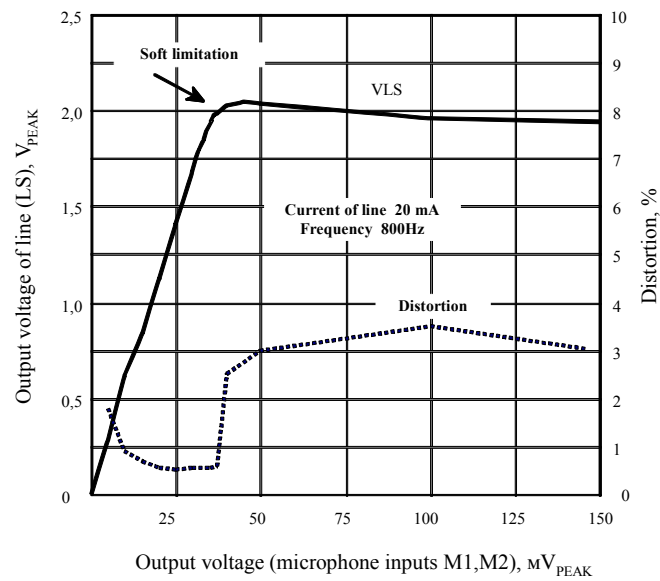
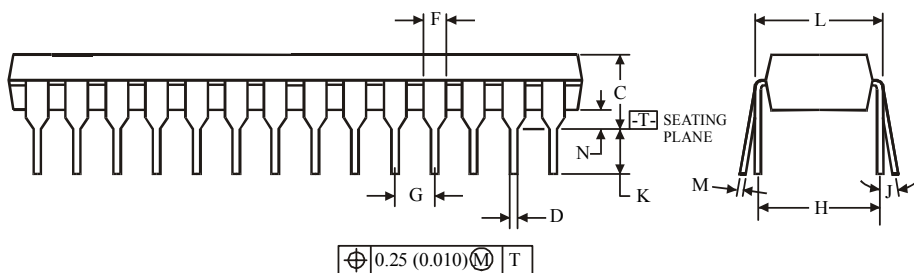
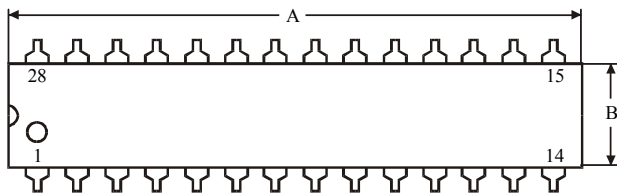
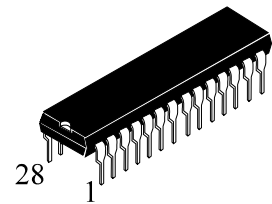


Figure 20 – Soft limitation and distortion during transfer

**N SUFFIX PLASTIC DIP
(MS - 001AB)**



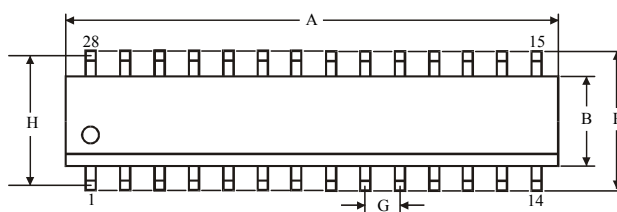
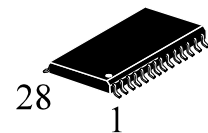
$\oplus 0.25 (0.010) \text{ (M) } | \text{ T}$

NOTES:

- Dimensions "A", "B" do not include mold flash or protrusions.
Maximum mold flash or protrusions 0.25 mm (0.010) per side.

Symbol	Dimension, mm	
	MIN	MAX
A	35.1	39.7
B	12.32	14.73
C		6.35
D	0.36	0.56
F	0.77	1.78
G	2.54	
H	15.24	
J	0°	10°
K	2.92	5.08
L	15.24	15.87
M	0.2	0.38
N	0.38	

**D SUFFIX SOIC
(MS - 059AD)**



$\oplus 0.25 (0.010) \text{ (M) } | \text{ T } | \text{ C } | \text{ (M)}$

NOTES:

- Dimensions A and B do not include mold flash or protrusion.
- Maximum mold flash or protrusion 0.15 mm (0.006) per side for A; for B - 0.25 mm (0.010) per side.

Symbol	Dimension, mm	
	MIN	MAX
A	17.7	18.5
B	8.23	8.9
C	2.35	3.05
D	0.35	0.5
F	0.4	1.27
G	1.27	
H	11.43	
J	0°	8°
K	0.05	0.35
M	0.14	0.32
P	11.5	12.7
R	0.25	0.75