

## GaAs PHEMT MMIC MEDIUM POWER AMPLIFIER, 6 - 18 GHz



### Typical Applications

The HMC441LC3B is ideal for use as a medium power amplifier for:

- Point-to-Point Radios
- Point-to-Multi-Point Radios & VSAT
- LO Driver for HMC Mixers
- Military EW & ECM

### Features

- Gain: 17 dB
- Saturated Power: +22 dBm @ 27% PAE
- Single Supply Voltage: +5.0 V
- 50 Ohm Matched Input/Output
- RoHS Compliant 3 x 3 mm SMT package

### Functional Diagram

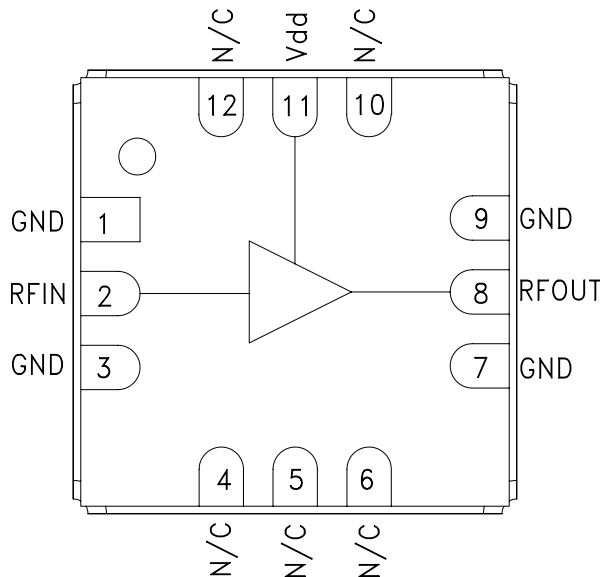

### General Description

The HMC441LC3B is an efficient GaAs PHEMT MMIC Medium Power Amplifier housed in a leadless “Pb free” RoHS compliant SMT package. Operating between 6.0 and 18.0 GHz, the amplifier provides 17 dB of gain, +22 dBm of saturated power and 27% PAE from a +5.0 V supply voltage. This 50 Ohm matched amplifier does not require any external components, making it an ideal linear gain block or driver for HMC SMT mixers. The HMC441LC3B allows the use of surface mount manufacturing techniques.

### Electrical Specifications, $T_A = +25^\circ C$ , $V_{dd} = +5V$

Parameter	Min.	Typ.	Max.	Min.	Typ.	Max.	Min.	Typ.	Max.	Min.	Typ.	Max.	Units
Frequency Range	6.0 - 8.5			8.5 - 12.5			12.5 - 14.0			14.0 - 18.0			GHz
Gain	10	14		13	17		14	17		10	14		dB
Gain Variation Over Temperature		0.015	0.02		0.015	0.02		0.015	0.02		0.015	0.02	dB/°C
Input Return Loss		10			13			20			13		dB
Output Return Loss		12			15			17			14		dB
Output Power for 1 dB Compression (P1dB)	16	19		17	20		17	20		17	20		dBm
Saturated Output Power (Psat)		20			21.5			22.5			21.5		dBm
Output Third Order Intercept (IP3)		30			32			32			32		dBm
Noise Figure		4.5			4.5			4.5			4.5		dB
Supply Current (Idd)		95			95			95			95		mA



# HMC441LC3B

## GaAs PHEMT MMIC MEDIUM POWER AMPLIFIER, 6 - 18 GHz

8

AMPLIFIERS - SMT

**Broadband Gain & Return Loss**

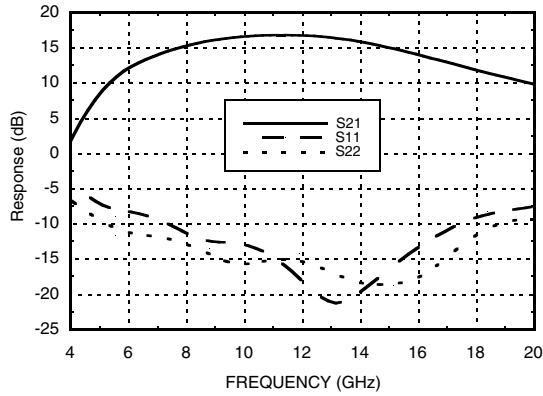

**Gain vs. Temperature**

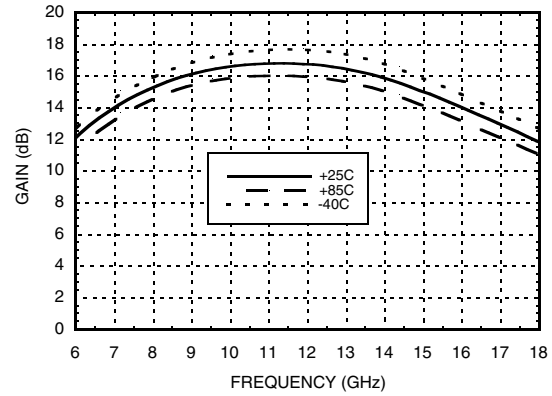

**Input Return Loss vs. Temperature**

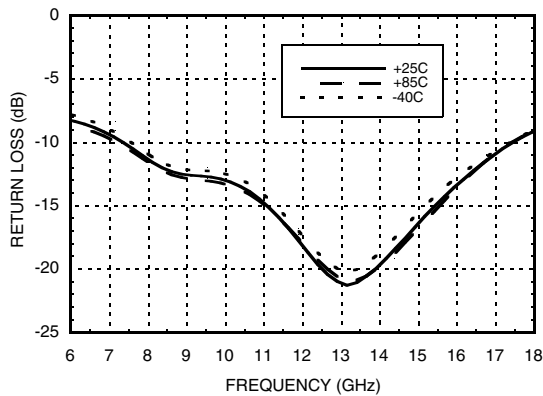

**Output Return Loss vs. Temperature**

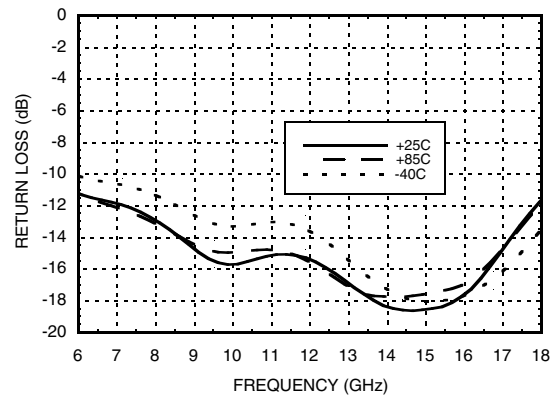

**P1dB vs. Temperature**

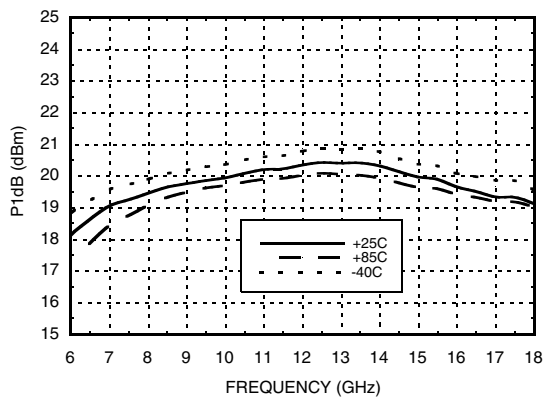

**Psat vs. Temperature**

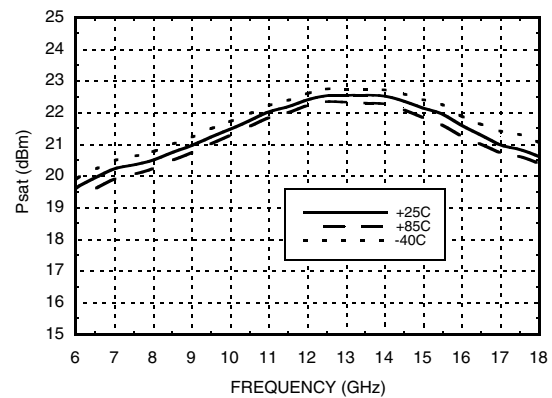

**GaAs PHEMT MMIC MEDIUM POWER AMPLIFIER, 6 - 18 GHz**



8

AMPLIFIERS - SMT

**Power Compression @ 11 GHz**

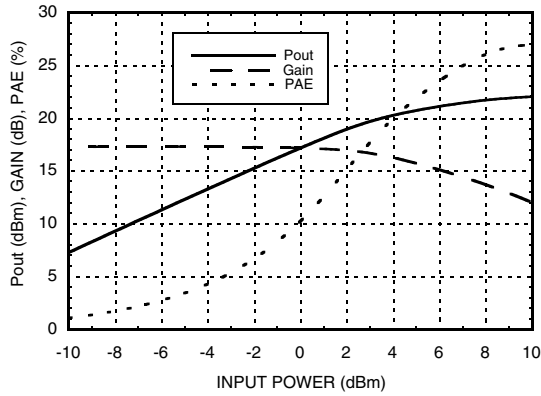

**Power Compression @ 15 GHz**

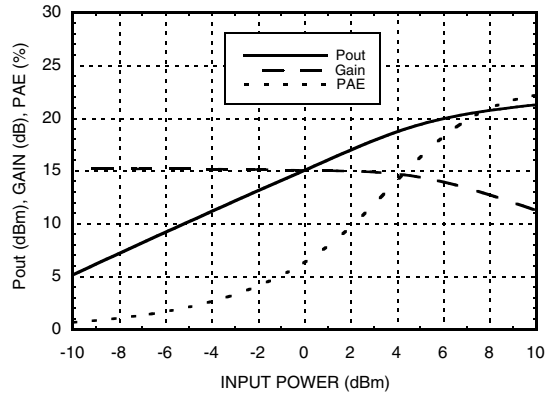

**Output IP3 vs. Temperature**

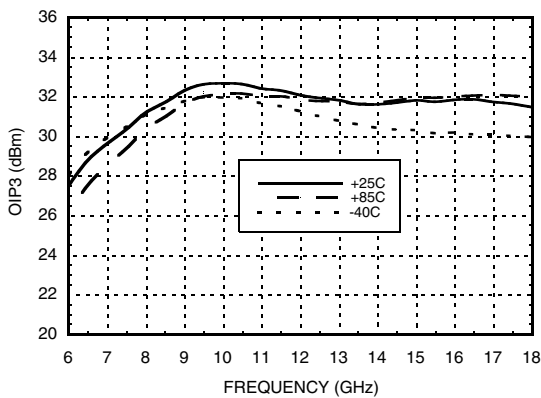

**Noise Figure vs. Temperature**

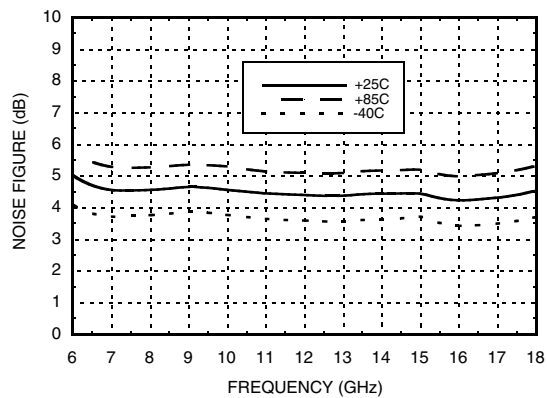

**Gain, Power & OIP3 vs. Supply Voltage @ 11 GHz**

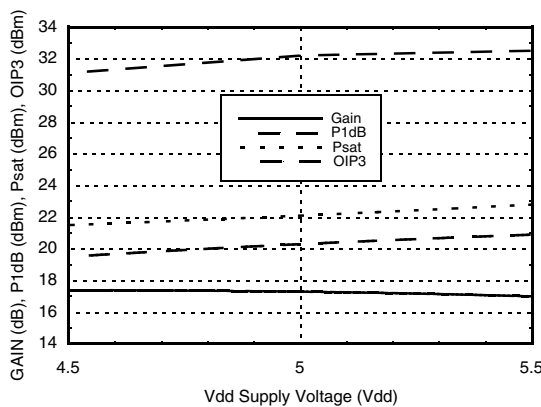

**Reverse Isolation vs. Temperature**

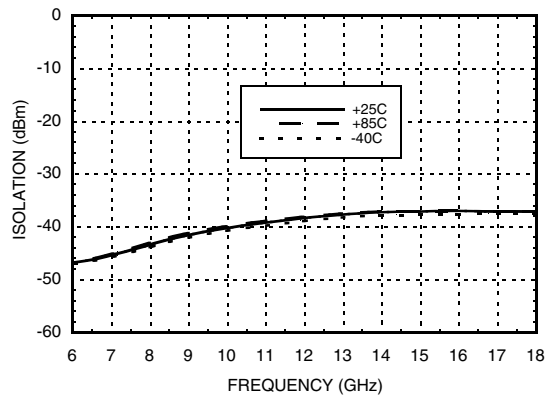



**Absolute Maximum Ratings**

Drain Bias Voltage (Vdd)	+6.0 Vdc
RF Input Power (RFIn)(Vdd = +5.0 Vdc)	+20 dBm
Channel Temperature	150 °C
Continuous Pdiss (T = 85 °C) (derate 10 mW/°C above 85 °C)	0.65 W
Thermal Resistance (channel to ground paddle)	100 °C/W
Storage Temperature	-65 to +150 °C
Operating Temperature	-40 to +85 °C
ESD Sensitivity (HBM)	Class 1A

**Typical Supply Current vs. Vdd**

Vdd (V)	Idd (mA)
+5.5	96
+5.0	95
+4.5	94

Note: Amplifier will operate over full voltage range shown above



ELECTROSTATIC SENSITIVE DEVICE  
OBSERVE HANDLING PRECAUTIONS

**Outline Drawing**

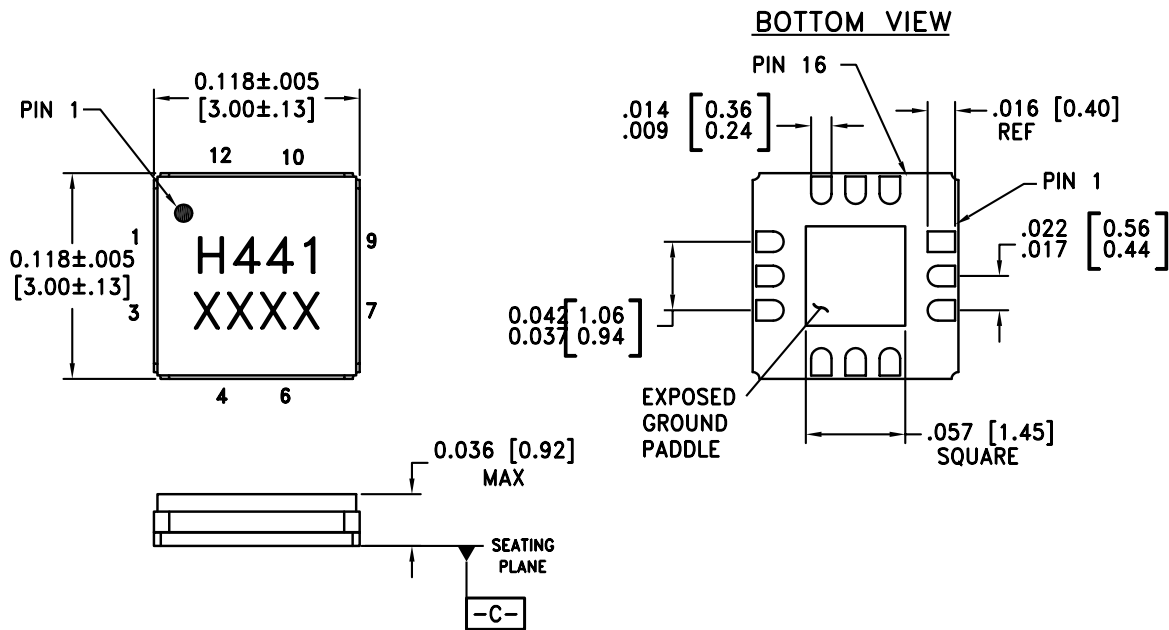

- NOTES:
1. PACKAGE BODY MATERIAL: ALUMINA
  2. LEAD AND GROUND PADDLE PLATING: COLD FLASH OVER Ni.
  3. DIMENSIONS ARE IN INCHES [MILLIMETERS].
  4. LEAD SPACING TOLERANCE IS NON-CUMULATIVE
  5. PACKAGE WARP SHALL NOT EXCEED 0.05mm.
  6. ALL GROUND LEADS AND GROUND PADDLE MUST BE SOLDERED TO PCB RF GROUND.



**Pin Descriptions**

Pin Number	Function	Description	Interface Schematic
1, 3, 7, 8	GND	Package bottom must also be connected to RF/DC ground	
2	RFIN	This pin is AC coupled and matched to 50 Ohms from 6 - 18 GHz.	
4 - 6, 10 - 12	N/C	This pin may be connected to RF/DC ground. Performance will not be affected.	
8	RFOUT	This pin is AC coupled and matched to 50 Ohms from 6 - 18 GHz.	
11	Vdd	Power Supply Voltage for the amplifier. External bypass capacitors are required.	

**Application Circuit**

Component	Value
C1	100 pF
C2	1,000 pF
C3	2.2 μF

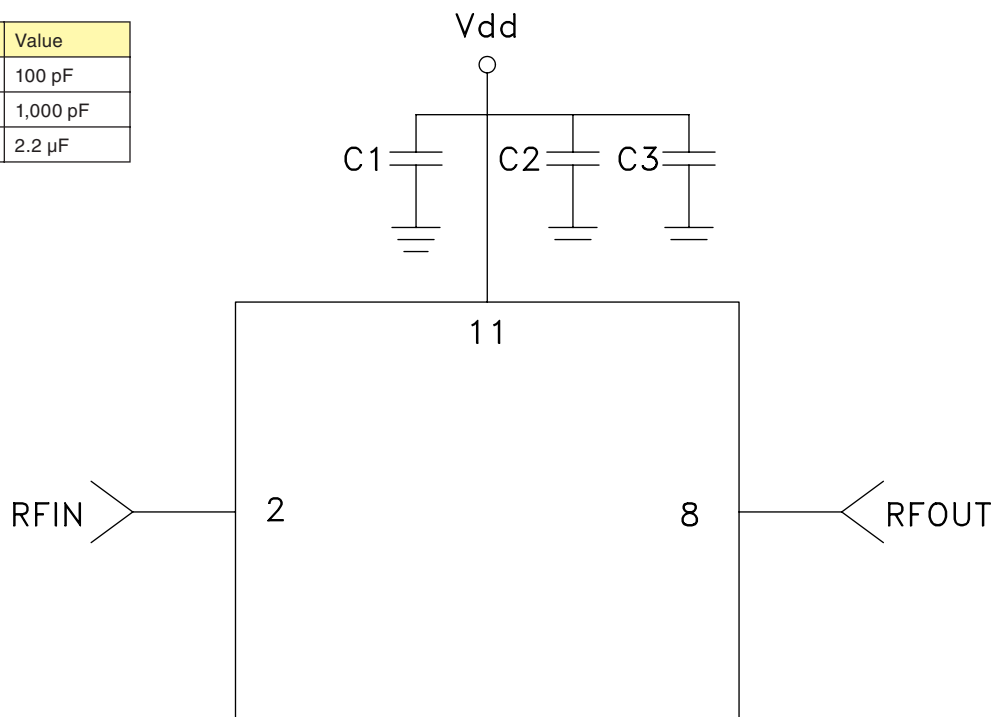



**Evaluation PCB**

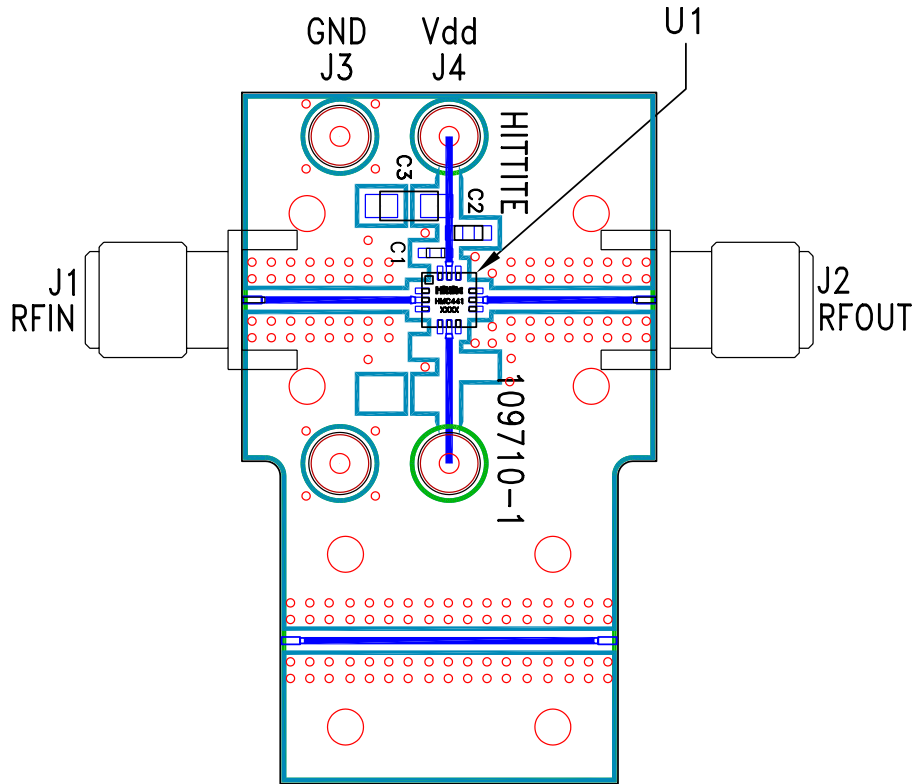

**List of Material for Evaluation PCB 109712\***

Item	Description
J1 - J2	PC Mount SMA Connector
J3 - J4	DC Pin
C1	100 pF Capacitor, 0402 Pkg.
C2	1000 pF Capacitor, 0603 Pkg.
C3	2.2 $\mu$ F Capacitor, Tantalum
U1	HMC441LC3B Amplifier
PCB*	109710 Evaluation PCB, 10 mils

\*\* Circuit Board Material: Rogers 4350

The circuit board used in the final application should use RF circuit design techniques. Signal lines should have 50 ohm impedance while the package ground leads and exposed paddle should be connected directly to the ground plane similar to that shown. A sufficient number of VIA holes should be used to connect the top and bottom ground planes. The evaluation board should be mounted to an appropriate heat sink. The evaluation circuit board shown is available from Hittite upon request.

\*\* Reference this number when ordering complete evaluation PCB