

# HA12231FP

Audio Signal Processor for Car Deck (PB 1 Chip)

## HITACHI

ADE-207-327A (Z)  
2nd Edition  
Jan. 2001

### Description

HA12231FP is silicon monolithic bipolar IC providing PB equalizer system and music sensor system in one chip.

### Functions

- PB equalizer   × 2 channel
- Music sensor   × 1 channel
- Line amp.       × 2 channel
- Line mute       × 2 channel

### Features

- No use external parts for PB equalizer. (Fixed characteristics built-in)
- Available to change music sensing level by external resistor.
- Available to change frequency response of music sensor by external capacitor.
- Different type of PB equalizer characteristics selection (120  $\mu$ s/70  $\mu$ s) is available.
- Line mute ON/OFF is available.
- This IC is strong for a cellular phone noise.

### Ordering Information

| Product   | Package | PBOUT-Level | Functions |              |      |
|-----------|---------|-------------|-----------|--------------|------|
|           |         |             | PB-EQ     | Music Sensor | Mute |
| HA12231FP | FP-20DA | 450 mVrms   | ○         | ○            | ○    |

# HA12231FP

**Pin Description, Equivalent Circuit** ( $V_{CC} = 9\text{ V}$ , A system of single supply voltage,  $T_a = 25^\circ\text{C}$ , No Signal, The value in the table shows typical value.)

| Pin No. | Pin Name | Note           | Equivalent Circuit | Description                     |
|---------|----------|----------------|--------------------|---------------------------------|
| 16      | TAI(L)   | $V = V_{CC}/2$ |                    | Tape input                      |
| 5       | TAI(R)   |                |                    |                                 |
| 14      | RIP      | $V = V_{CC}/2$ |                    | Ripple filter                   |
| 13      | MS DET   | $V = V_{CC}$   |                    | Time constant pin for rectifier |
| 15      | PBOUT(L) | $V = V_{CC}/2$ |                    | PB output                       |
| 6       | PBOUT(R) |                |                    |                                 |
| 1       | VREF     | $V = V_{CC}/2$ |                    | Reference output                |
| 17      | EQOUT(L) | $V = V_{CC}/2$ |                    | Equalizer output ( $120\ \mu$ ) |
| 4       | EQOUT(R) |                |                    |                                 |

Note: MS: Music Sensor

**HITACHI**

**Pin Description, Equivalent Circuit** ( $V_{CC} = 9\text{ V}$ , A system of single supply voltage,  $T_a = 25^\circ\text{C}$ , No Signal, The value in the table shows typical value.) (cont.)

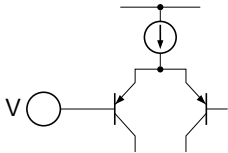
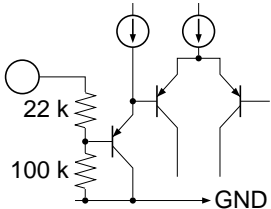
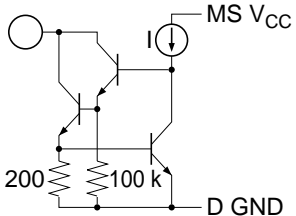
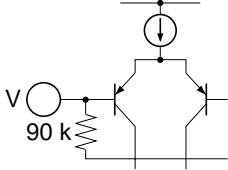
| Pin No. | Pin Name                    | Note           | Equivalent Circuit  | Description          |
|---------|-----------------------------|----------------|---|----------------------|
| 11      | $V_{CC}$                    | —              |   | Power supply         |
| 19      | FIN(L)                      | —              |    | Equalizer input      |
| 18      | RIN(L)                      |                |   |                      |
| 3       | RIN(R)                      |                |   |                      |
| 2       | FIN(R)                      |                |   |                      |
| 9       | Mute                        | —              |    | Mode control input   |
| 10      | $\overline{\text{FOR/REV}}$ |                |   |                      |
| 8       | $\overline{\text{I20/70}}$  |                |   |                      |
| 12      | MS                          | —              |   | MS output (to MPU) * |
| 7       | MS $G_v$                    | $V = V_{CC}/2$ |  | MS gain pin *        |
| 20      | GND                         | —              |   | GND pin              |

Note: MS: Music Sensor

## Block Diagram

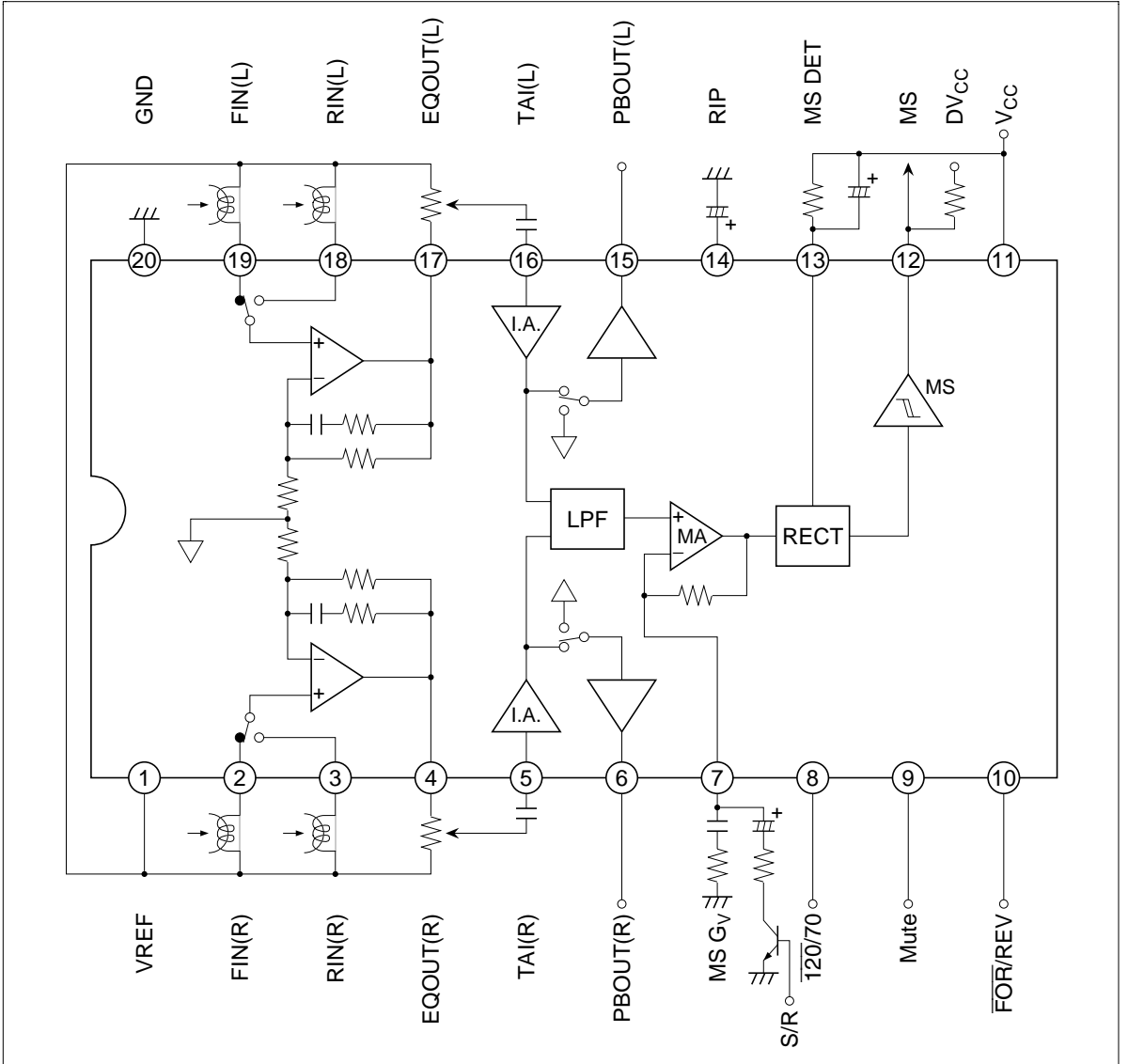

**Absolute Maximum Ratings** ( $T_a = 25^{\circ}\text{C}$ )

| <b>Item</b>           | <b>Symbol</b> | <b>Rating</b> | <b>Unit</b>        | <b>Note</b>                   |
|-----------------------|---------------|---------------|--------------------|-------------------------------|
| Supply voltage        | $V_{cc}$ Max  | 15            | V                  |                               |
| Power dissipation     | $P_d$         | 400           | mW                 | $T_a \leq 85^{\circ}\text{C}$ |
| Operating temperature | $T_{opr}$     | -40 to +85    | $^{\circ}\text{C}$ |                               |
| Storage temperature   | $T_{stg}$     | -55 to +125   | $^{\circ}\text{C}$ |                               |

---

## Electrical Characteristics

(Ta = 25°C, V<sub>CC</sub> = 9 V, PBOUIT Level = 450 mVrms (= 0 dB))

| Item                                   | Symbol                   | Test Condition |              |         |                  |                             |       |       |                 |       |     | Application Terminal | Re-mark |          |   |   |
|--|--------------------------|----------------|--------------|---------|------------------|-----------------------------|-------|-------|-----------------|-------|-----|----------------------|---------|----------|---|---|
|  |                          | IC Condition   |              |         | Specification    |                             |       |       | Input           |       |     |                      |         | Output   |   |   |
|  |                          | INPUT          | OUTPUT       | fin(Hz) | PBOUIT level(dB) | Other                       | Min   | Typ   | Max             | Unit  | R   |                      |         | L        | R | L |
| Quiescent current                      | I <sub>Q</sub>           | —              | —            | —       | —                | No signal                   | —     | 6.0   | 9               | mA    | —   | —                    | —       | 11       |   |   |
| Input AMP. gain                        | G <sub>V</sub> /A        | TAI            | PBOUIT       | 1k      | 0                | —                           | 22.5  | 23.5  | 24.5            | dB    | 5   | 16                   | 6       | 15       |   |   |
| Signal handling                        | Vomax                    | TAI            | PBOUIT       | 1k      | —                | THD = 1%                    | 12.0  | 13.0  | —               | dB    | 5   | 16                   | 6       | 15       |   |   |
| T.H.D.                                 | THD                      | TAI            | PBOUIT       | 1k      | 0                | —                           | —     | 0.05  | 0.3             | %     | 5   | 16                   | 6       | 15       |   |   |
| Channel separation                     | CT RL                    | FIN            | PBOUIT       | 1k      | 12               | —                           | 50.0  | 60.0  | —               | dB    | 2   | 19                   | 6→15    | →6       |   |   |
| PB-EQ gain                             | G <sub>V</sub> EQ 1k     | FIN/RIN        | EQOUT        | 1k      | 0                | 120μs                       | 37.0  | 40.0  | 43.0            | dB    | 2/3 | 19/18                | 4       | 17       |   |   |
|  | G <sub>V</sub> EQ 10k(1) | FIN            | EQOUT        | 10k     | 0                | 120μs                       | 33.0  | 36.0  | 39.0            | dB    | 2   | 19                   | 4       | 17       |   |   |
|  | G <sub>V</sub> EQ 10k(2) | FIN            | EQOUT        | 10k     | 0                | 70μs                        | 29.0  | 32.0  | 35.0            | dB    | 2   | 19                   | 4       | 17       |   |   |
| PB-EQ maximum output                   | V <sub>OM</sub>          | FIN/RIN        | EQOUT        | 1k      | —                | THD = 1%                    | 300   | 600   | —               | mVrms | 2/3 | 19/18                | 4       | 17       |   |   |
| PB-EQ THD                              | THD-EQ                   | FIN/RIN        | EQOUT        | 1k      | 0                | —                           | —     | 0.1   | 0.5             | %     | 2/3 | 19/18                | 4       | 17       |   |   |
| Noise voltage level converted in input | V <sub>N</sub>           | FIN/RIN        | EQOUT        | (1k)    | (0)              | Rg = 680Ω, Din-Audio Filter | —     | 1.2   | 2.0             | μVrms | 2/3 | 19/18                | 4       | 17       |   |   |
| MS sensing level                       | V <sub>ON</sub>          | TAI            | PBOUIT MSOUT | 5k      | —                | —                           | -18.0 | -14.0 | -10.0           | dB    | 5   | 16                   | 6       | 15       |   |   |
| MS output low level                    | V <sub>OL</sub>          | TAI            | PBOUIT MSOUT | 5k      | 0                | —                           | —     | 1.0   | 1.5             | V     | 5   | 16                   | 6       | 15       |   |   |
| MS output leak current                 | I <sub>OH</sub>          | —              | MSOUT        | —       | —                | No signal                   | —     | 0.0   | 2.0             | μA    | —   | —                    | 12      | 12       |   |   |
| MUTE attenuation                       | Mute                     | TAI            | PBOUIT       | 1k      | 12               | —                           | 70.0  | 80.0  | —               | dB    | 5   | 16                   | 6       | 15       |   |   |
| Control voltage                        | V <sub>IL</sub>          | —              | —            | —       | —                | —                           | -0.2  | —     | 1.0             | V     | —   | —                    | —       | 8, 9, 10 |   |   |
|  | V <sub>IH</sub>          | —              | —            | —       | —                | —                           | 3.5   | —     | V <sub>CC</sub> | —     | —   | —                    | —       | —        |   |   |

Note: 1. V<sub>CC</sub> = 7.2 V

Test Circuit

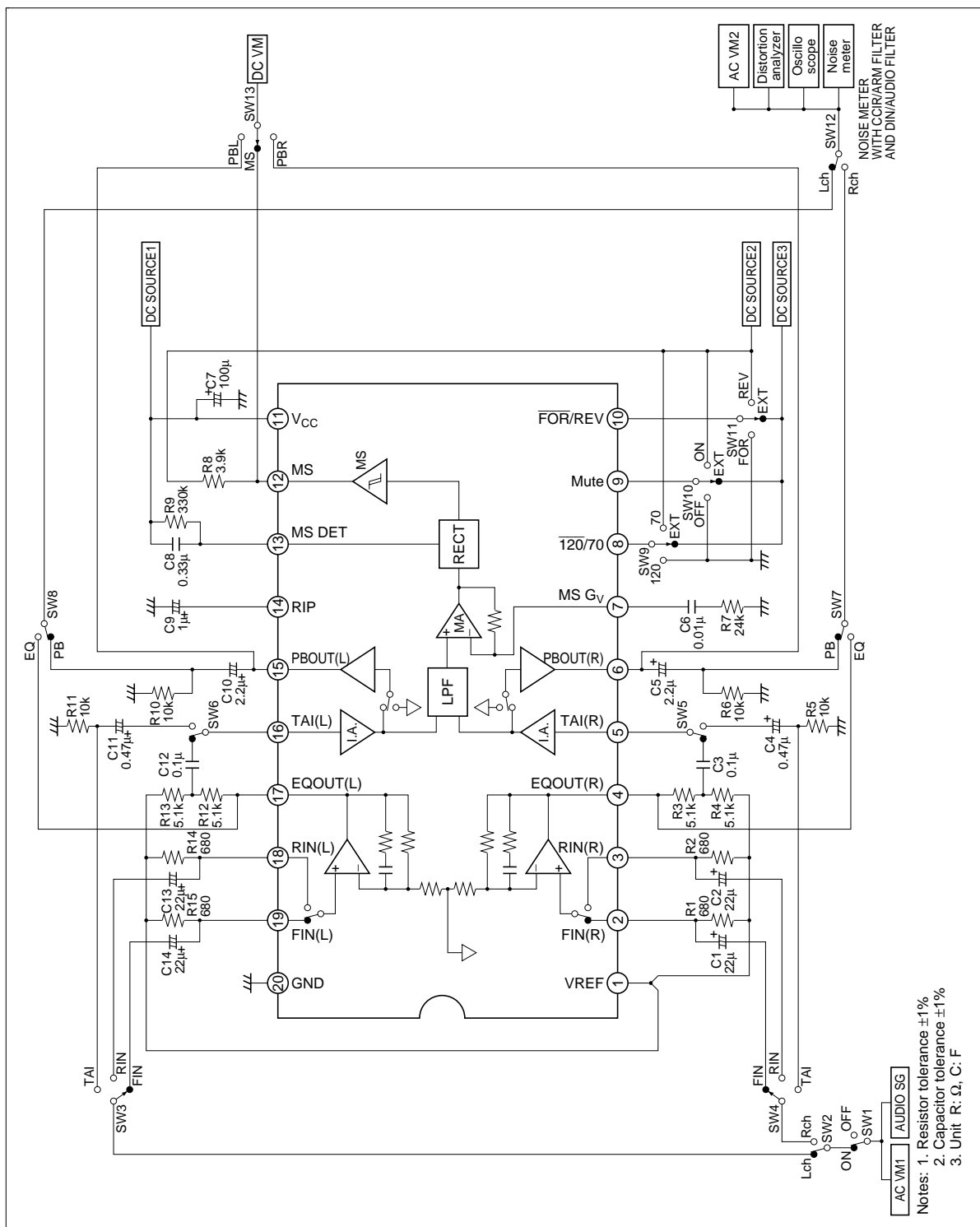

Notes: 1. Resistor tolerance  $\pm 1\%$   
 2. Capacitor tolerance  $\pm 1\%$   
 3. Unit R:  $\Omega$ , C: F

## Functional Description

### Power Supply Range

HA12231FP is designed to operate on single supply only.

**Table 1** Supply Voltage Range

| Product   | Single Supply   |
|-----------|-----------------|
| HA12231FP | 7.2 V to 12.0 V |

### Reference Voltage

HA12231FP provides the reference voltage of half the supply voltage that is the signal grounds. As the peculiarity of this device, the capacitor for the ripple filter is very small about 1/100 compared with their usual value. The block diagram is shown as figure 1.

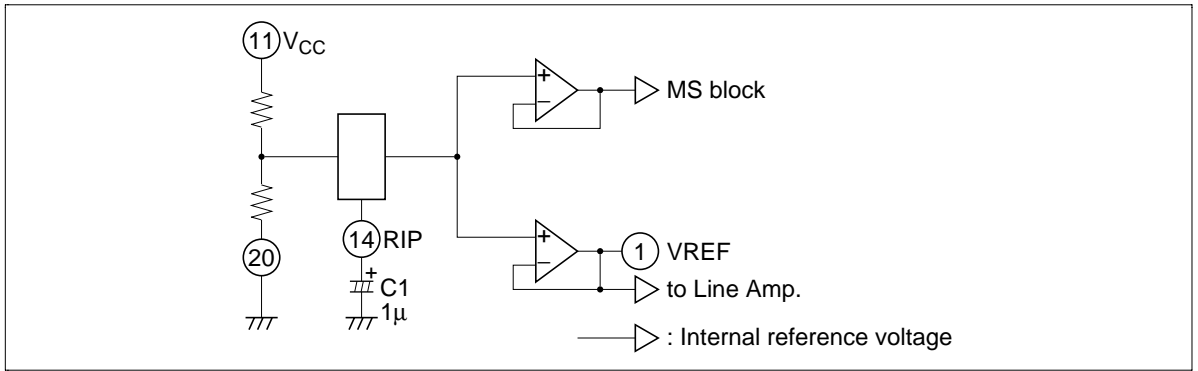

**Figure 1** The Block Diagram of Reference Supply Voltage



**Operating Mode Control**

HA12231FP provides fully electronic switching circuits. And each operating mode control are controlled by parallel data (DC voltage).

When a power supply of this IC is cut off, for a voltage, in addition to a mode control terminal even though as do not destruct it, in series for resistance.

**Table 2 Threshold Voltage ( $V_{TH}$ )**

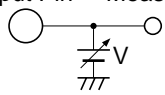
| Pin No.  | Lo          | Hi              | Unit | Test Condition  |
|----------|-------------|-----------------|------|---|
| 8, 9, 10 | -0.2 to 1.0 | 3.5 to $V_{CC}$ | V    | Input Pin Measure<br> |

**Table 3 Switching Truth Table**

| Pin No. | Pin Name             | Low                | High                       |
|---------|----------------------|--------------------|----------------------------|
| 8       | $\overline{120/70}$  | 120 $\mu$ (Normal) | 70 $\mu$ (Metal or Chrome) |
| 9       | Mute                 | Mute OFF           | Mute ON                    |
| 10      | $\overline{FOR/REV}$ | Forward            | Reverse                    |

- Notes:
1. Each pins are on pulled down with 100 k $\Omega$  internal resistor. Therefore, it will be low-level when each pins are open.
  2. Over shoot level and under shoot level of input signal must be the standardized. (High:  $V_{CC}$ , Low: -0.2 V)
  3. Reducing pop noise is so much better for 10 k $\Omega$  to 22 k $\Omega$  resisor and 1  $\mu$ F to 22  $\mu$ F capacitor shown figure 2.

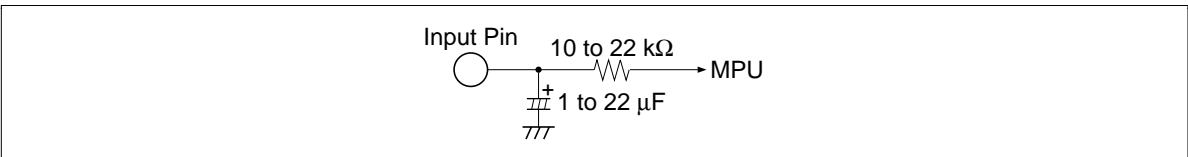

**Figure 2 Interface for Reduction of Pop Noise**

## Input Block Diagram and Level Diagram

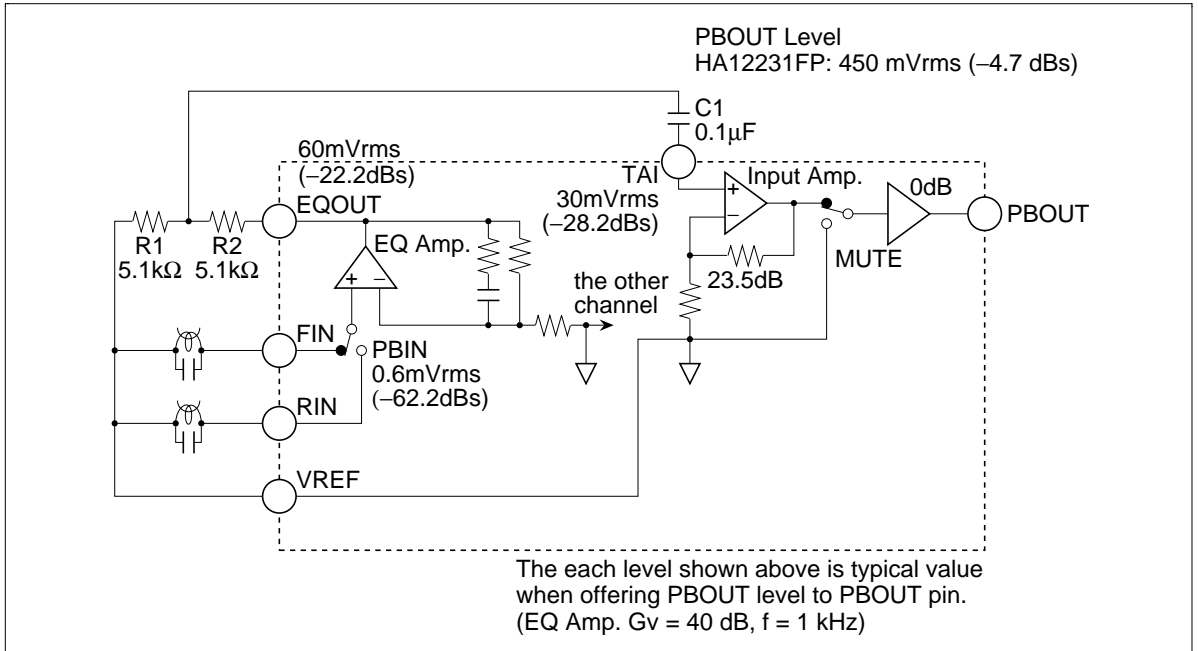

Figure 3 Input Block Diagram

### Adjustment of Playback Reference Operate Level

After replace R1 and R2 with a half-fix volume of 10 kΩ, adjust playback reference operate level.

**The Sensitivity Adjustment of Music Sensor**

Adjusting MS Amp. gain by external resistor, the sensitivity of music sensor can set up. The music sensor block diagram is shown in figure 4, and frequency response is shown in figure 5.

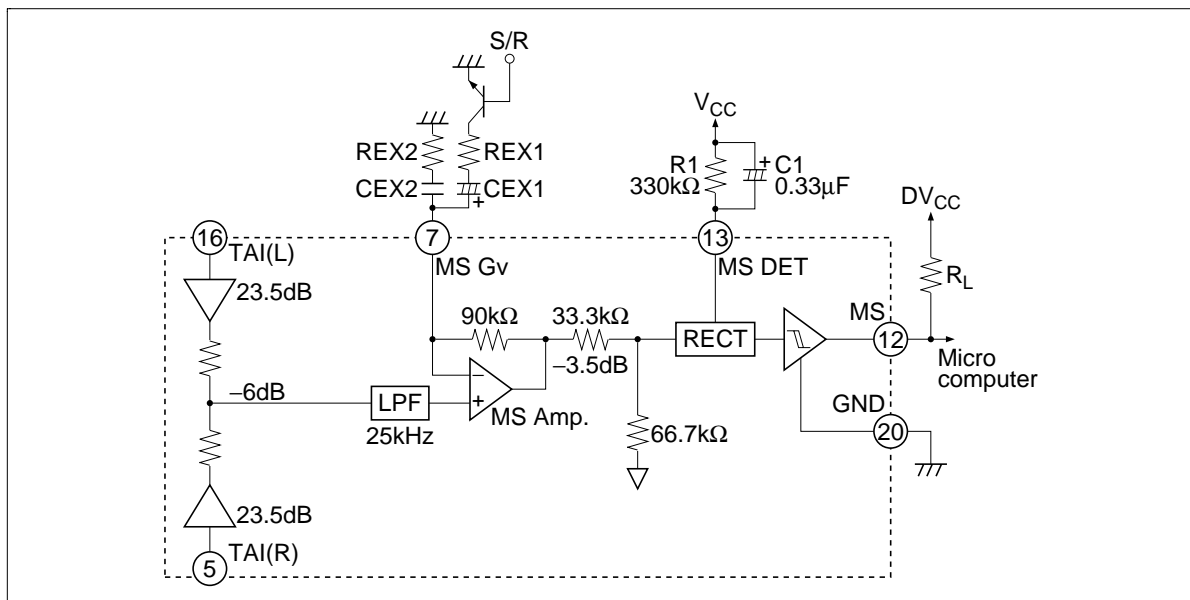

**Figure 4 Music Sensor Block Diagram**

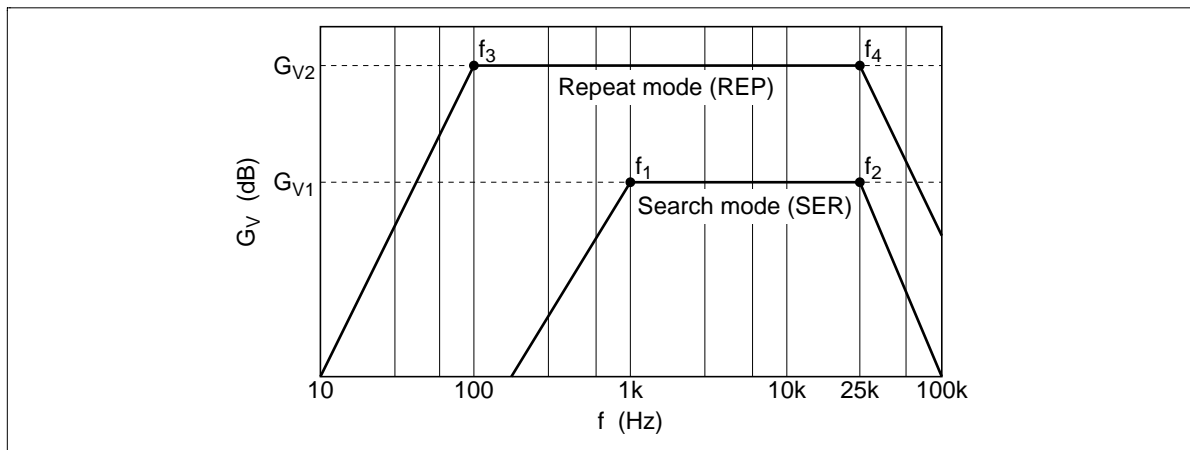

**Figure 5 Frequency Response**

## 1. Search mode

$$G_{V1} = (23.5\text{dB} - 3.5\text{dB}) + 20\log\left(1 + \frac{90\text{k}}{\text{REX2}}\right) \text{ [dB]}$$

$$f_1 = \frac{1}{2\pi \cdot \text{CEX2} \cdot \text{REX2}} \text{ [Hz]}, f_2 = 25\text{k} \text{ [Hz]}$$

## 2. Repeat mode

$$G_{V2} = (23.5\text{dB} - 3.5\text{dB}) + 20\log\left(1 + \frac{90\text{k}}{\text{REX1}}\right) \text{ [dB]}$$

$$f_3 = \frac{1}{2\pi \cdot \text{CEX1} \cdot \text{REX1}} \text{ [Hz]}, f_4 = 25\text{k} \text{ [Hz]}$$

The sensitivity of music sensor (S) is computed by the formula mentioned below.

$$S = 12.7 - G_V \text{ [dB]}$$

S is 6 dB down in case of one-side channel.

Notes: 1. Search mode:  $G_{V1}$ , Repeat mode:  $G_{V2}$

2. Standard level of TAI pin (Dolby level correspondence) = 30 mVrms

3. Standard sensing level of music sensor = 130 mVrms

| Item        | REX1, 2 | CEX1, 2 | $G_{V1, 2}$ | $f_{1, 3}$ | $f_{2, 4}$ | S<br>(one side<br>channel) | S<br>(both<br>channel) |
|-------------|---------|---------|-------------|------------|------------|----------------------------|------------------------|
| Search mode | 24 kΩ   | 0.01 μF | 33.5 dB     | 663 Hz     | 25 kHz     | -14.8 dB                   | -20.8 dB               |
| Repeat mode | 2.4 kΩ  | 1 μF    | 51.7 dB     | 66.3 Hz    | 25 kHz     | -33.0 dB                   | -39.0 dB               |

Note: This MS presented hysteresis lest MS(OUT) terminal should turn over again High level or Low level, in case of thresh S level constantly.

## Music Sensor Time Constant

1. Sensing no signal to signal (Attack) is determined by C1, 0.01 μF to 1 μF capacitor C1 can be applicable.
2. Sensing signal to no signal (Recovery) is determined by C1 and R1, however preceding (1), 100 kΩ to 1 MΩ can be applicable.

## Music Sensor Output (MS(OUT))

As for the internal circuit of music sensor block, music sensor output pin is connected to the collector of NPN type directly, therefore, output level will be “high” when sensing no signal. And output level will be “low” when sensing signal.

$$I_L = \frac{DV_{CC} - \text{MS(OUT)}_{LO}^*}{R_L}$$

\* MS(OUT)<sub>LO</sub> : Sensing signal (about 1V)

Note: Supply voltage of MS(OUT) pin must be less than  $V_{CC}$  voltage.

Characteristic Curves

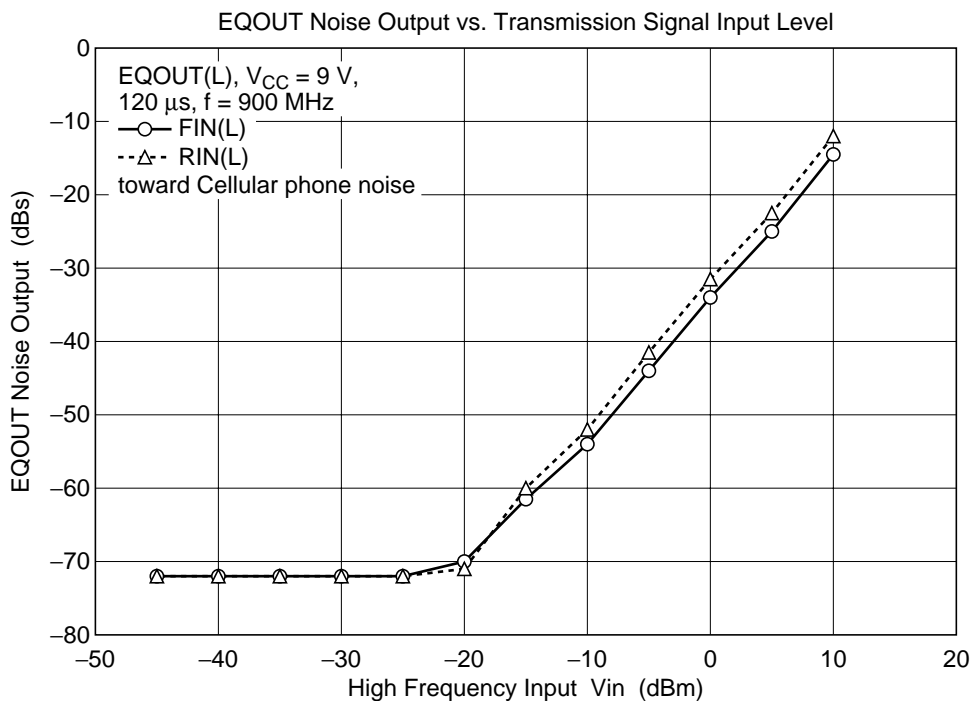
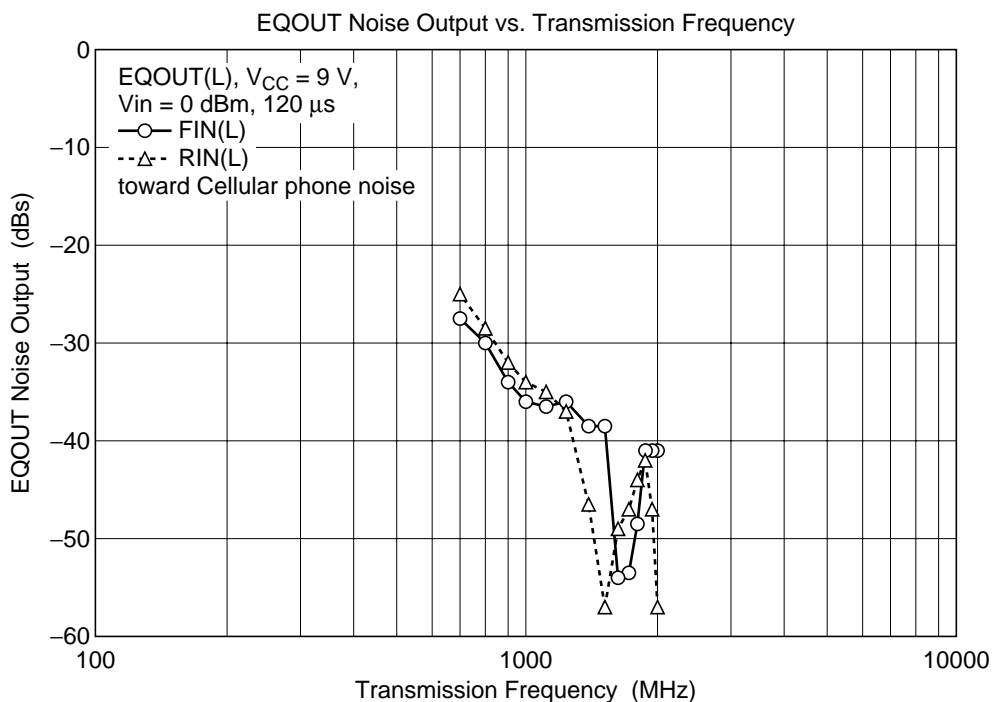

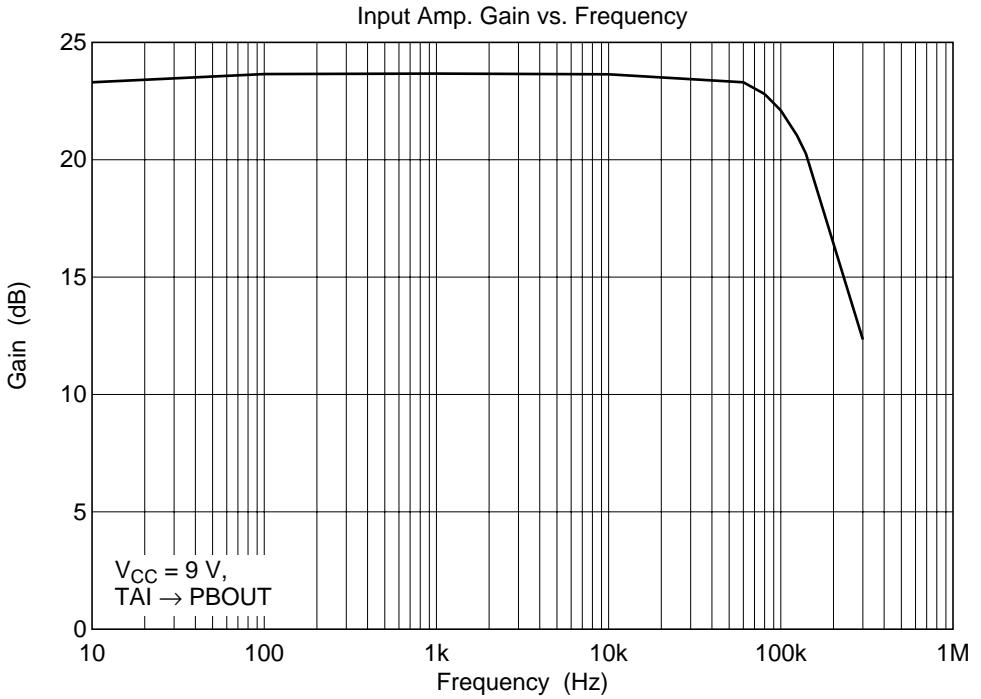
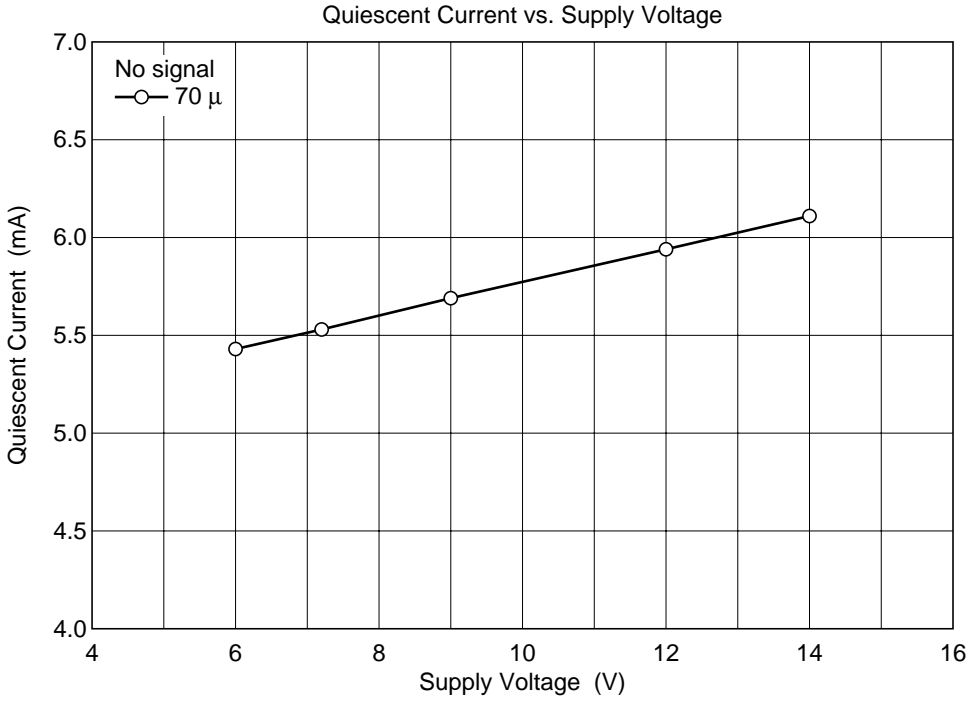

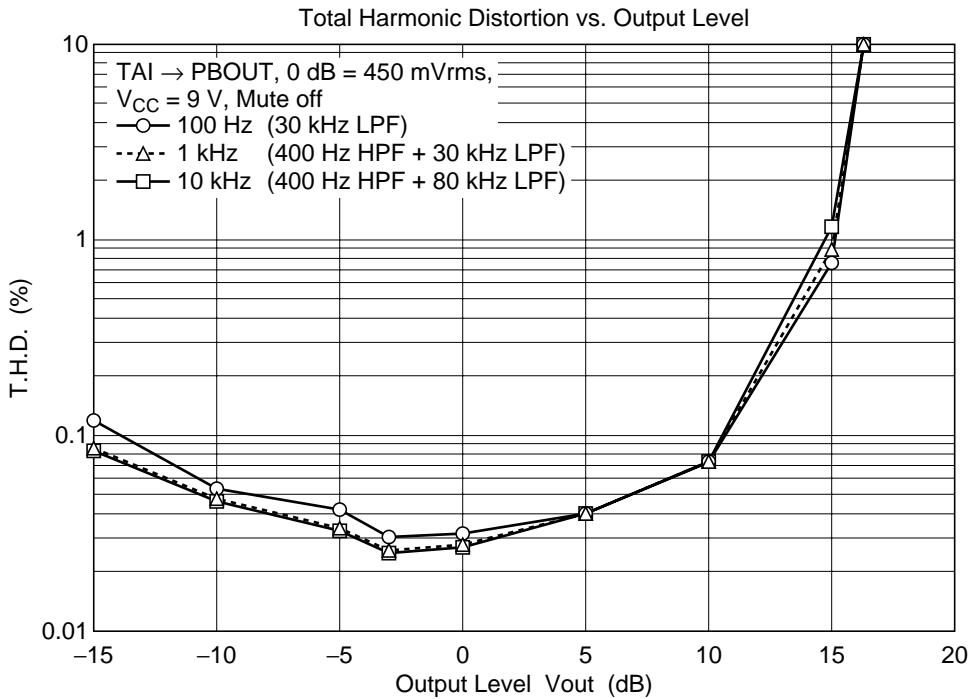
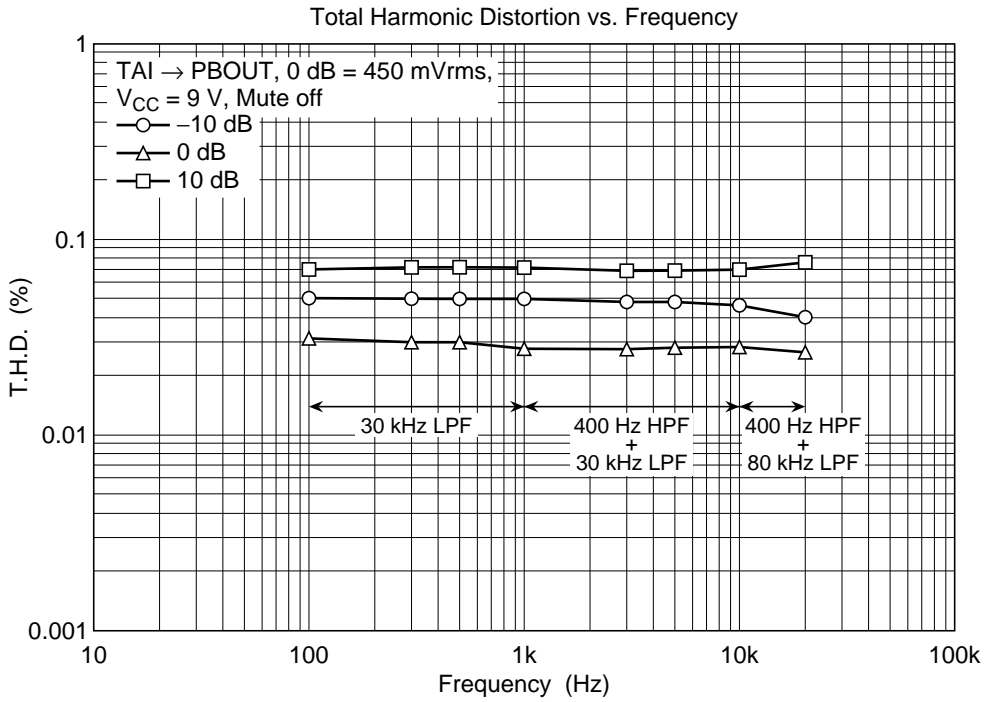

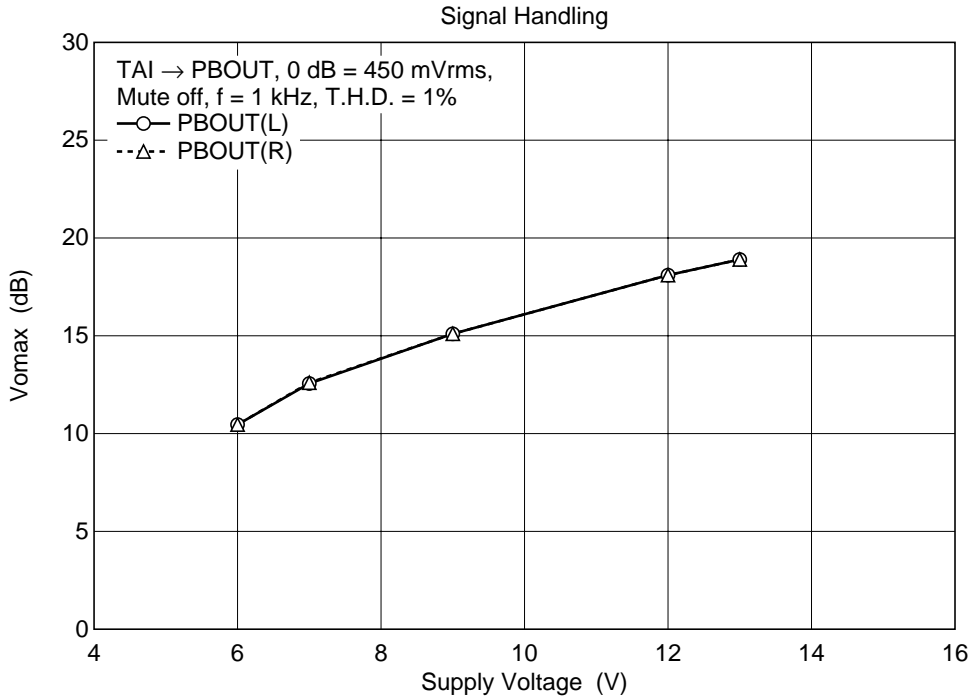
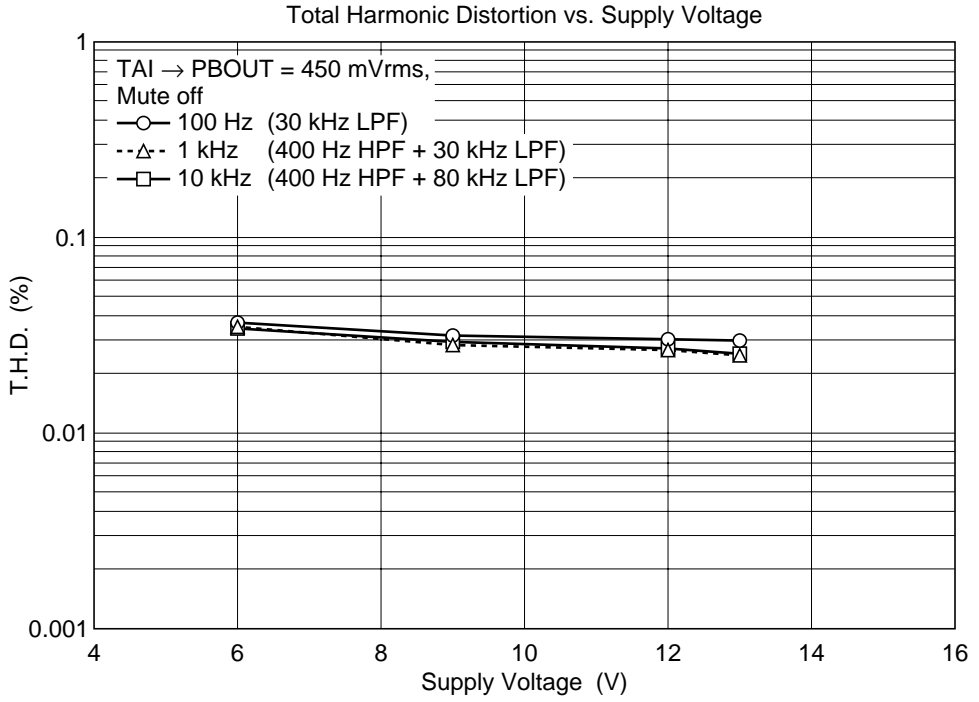



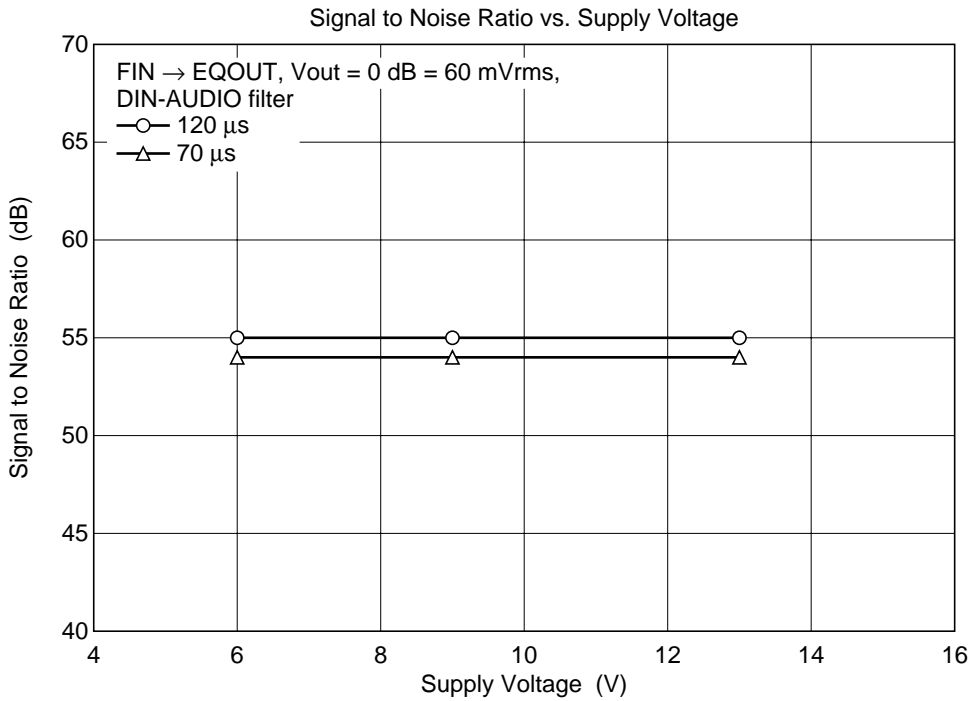
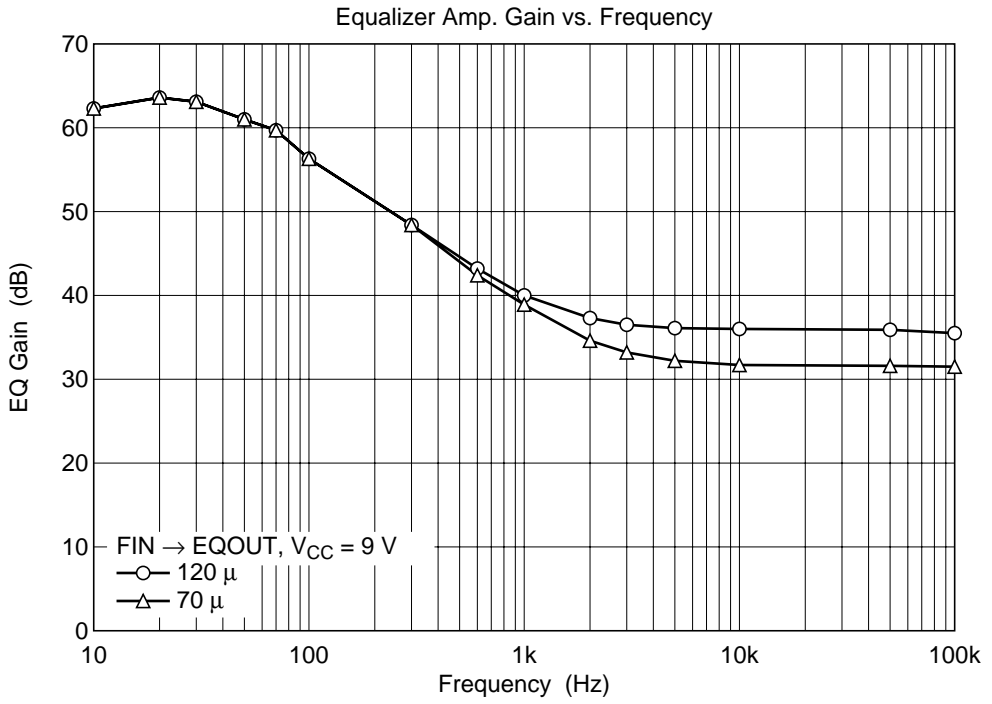

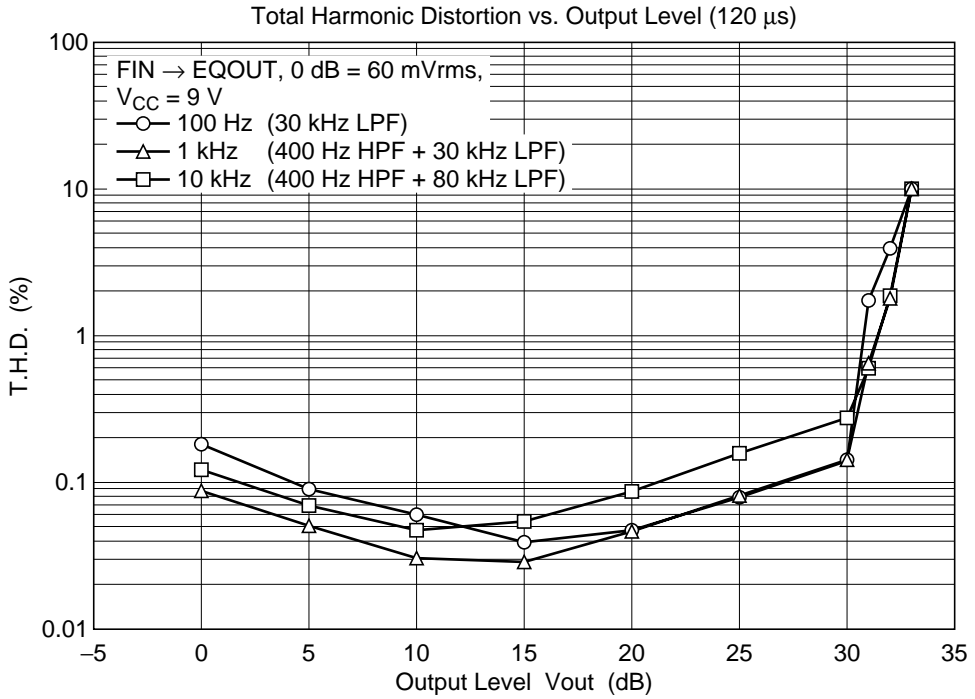
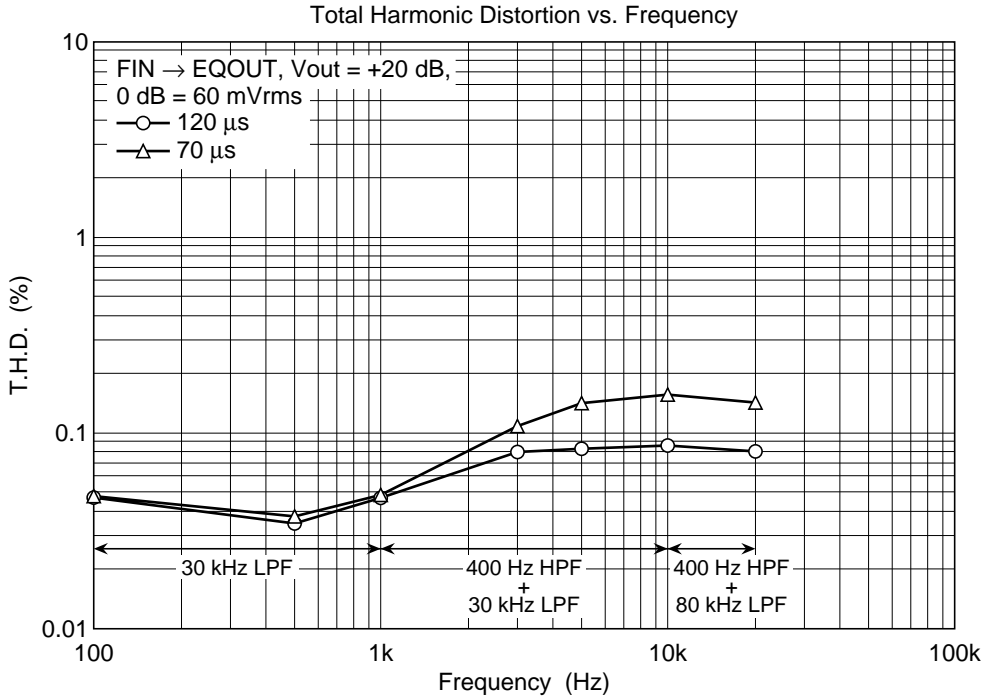

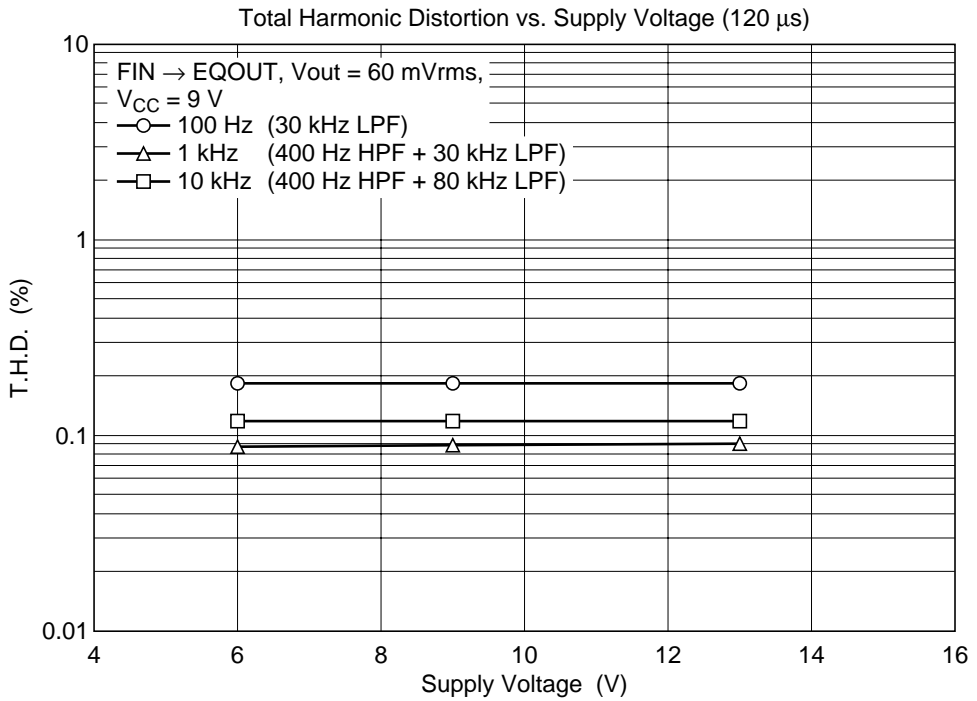
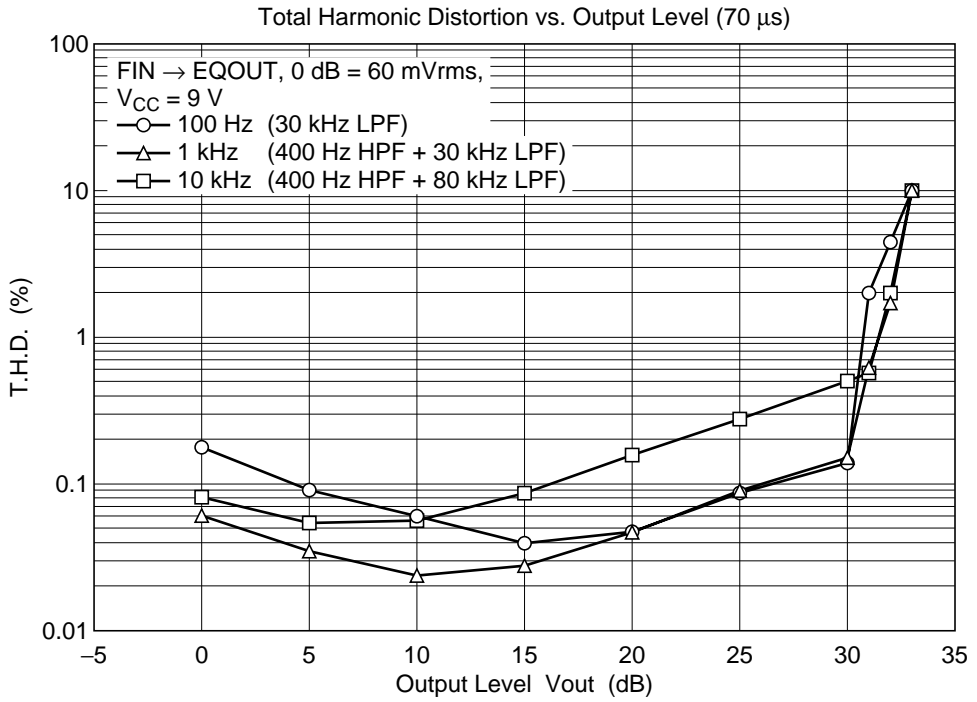

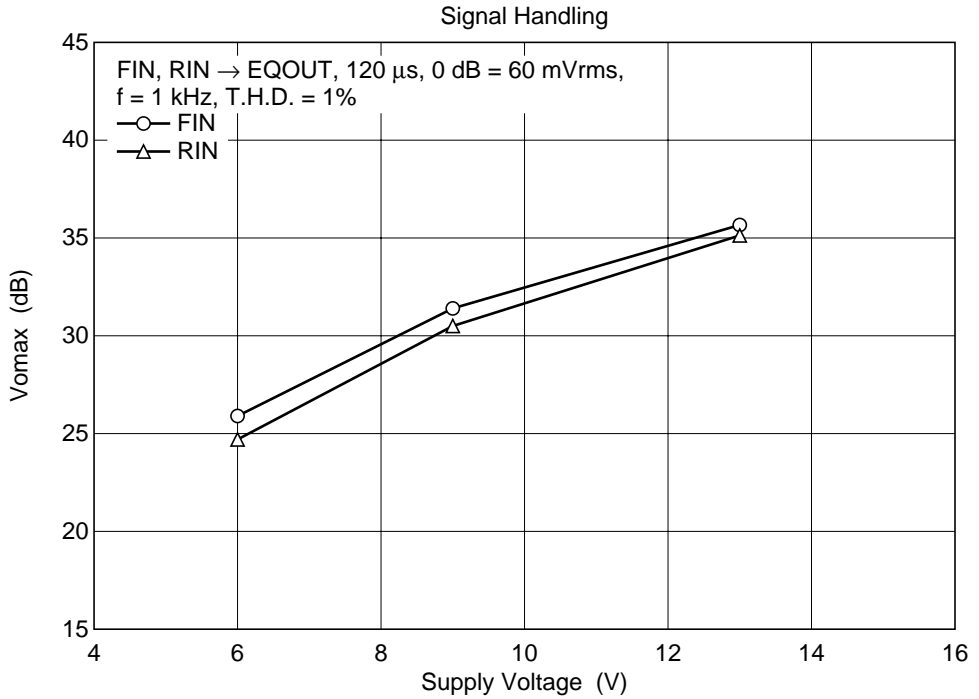
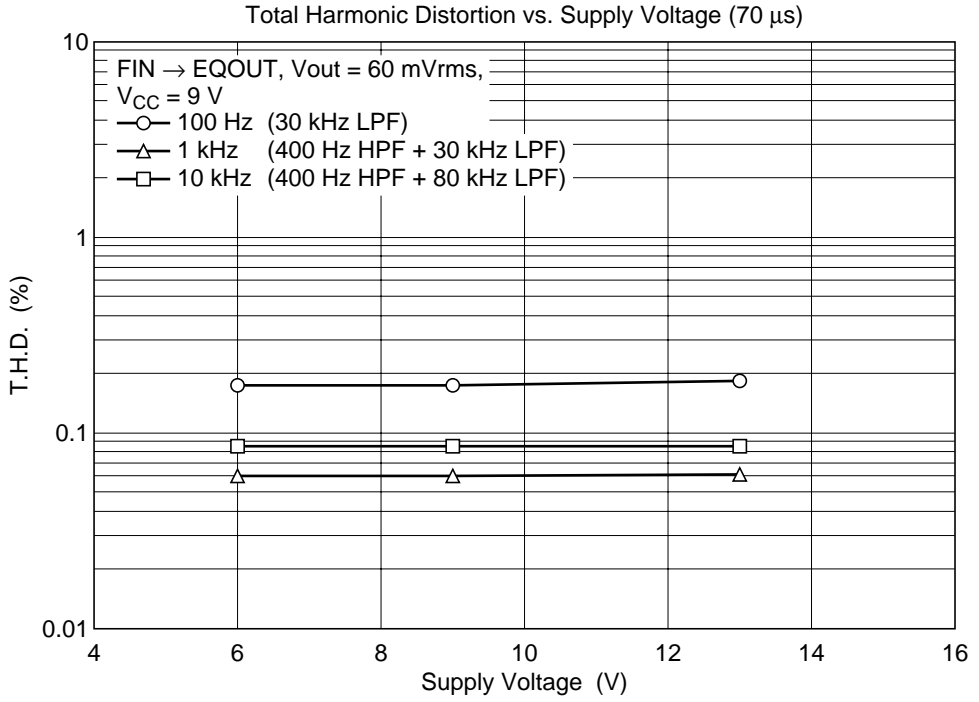

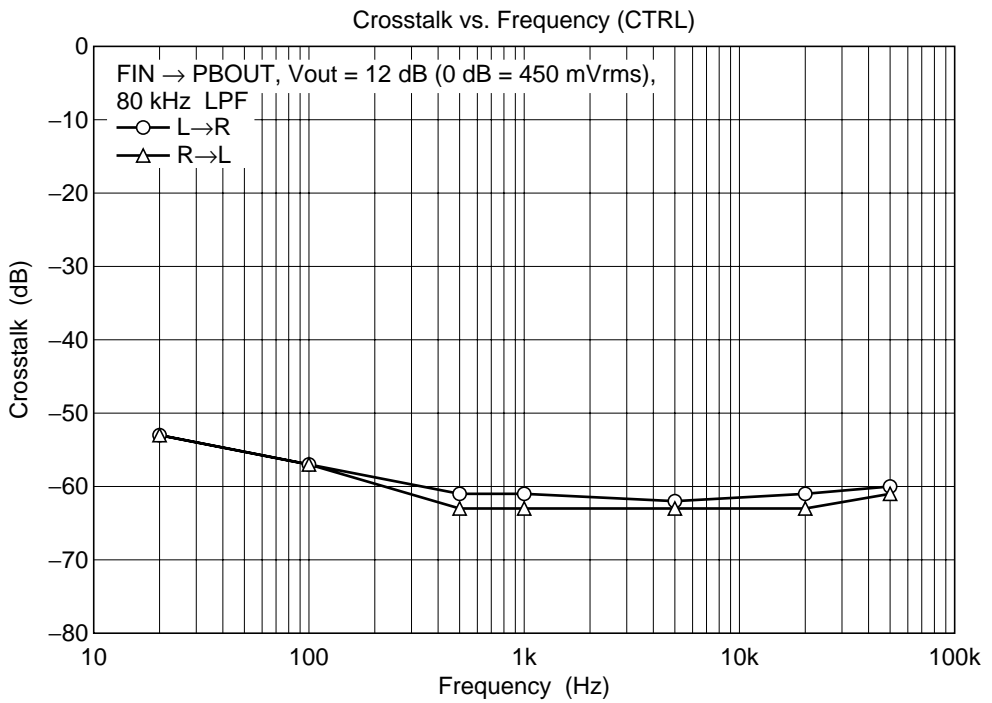
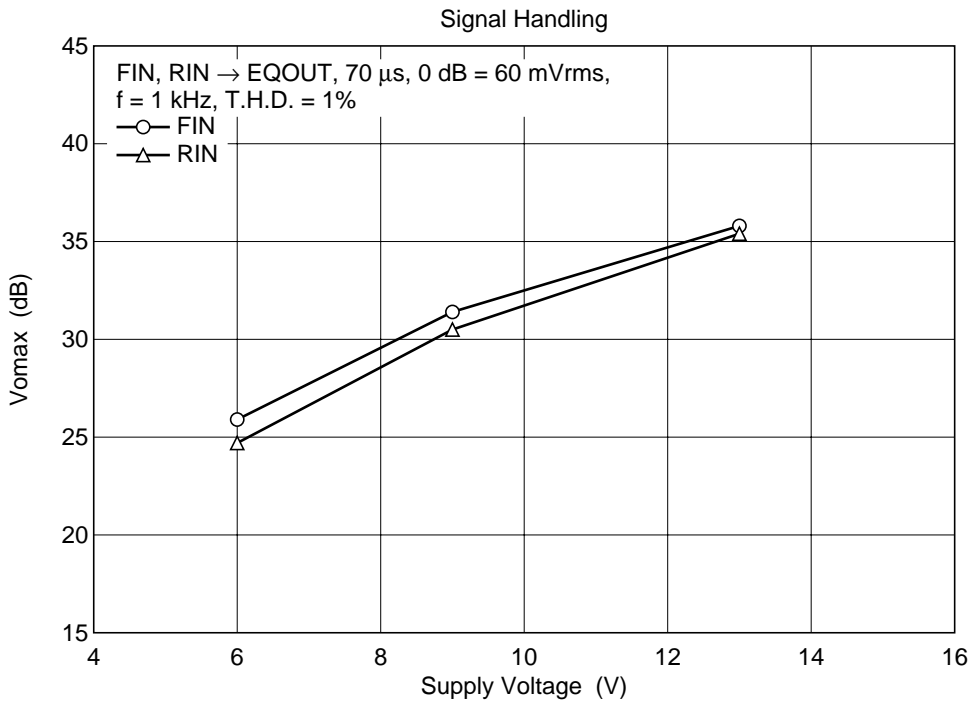

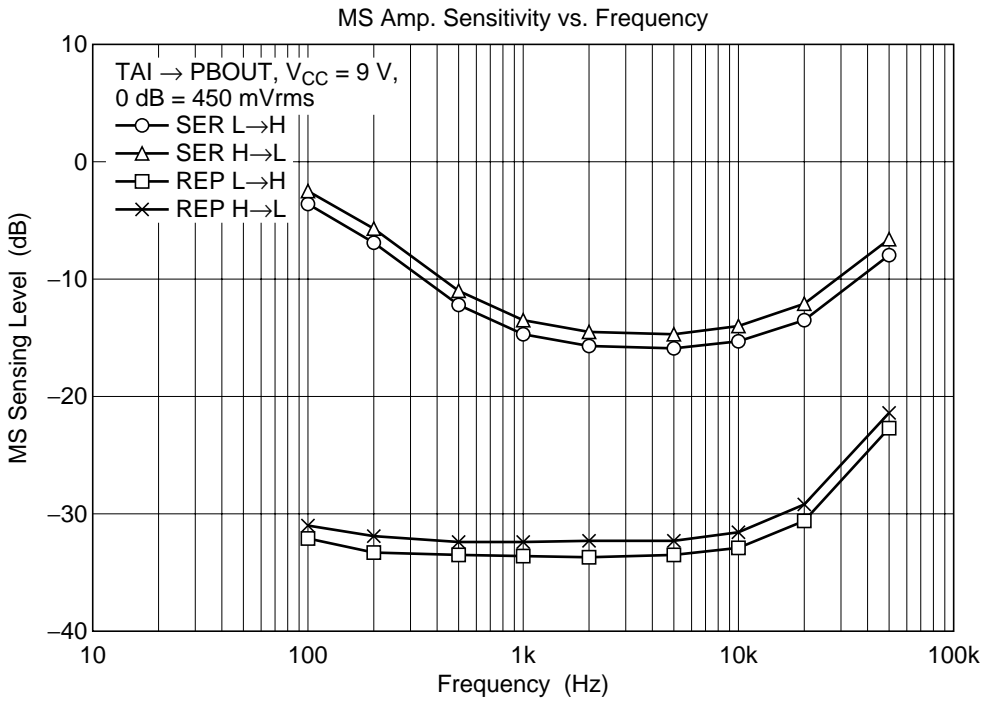
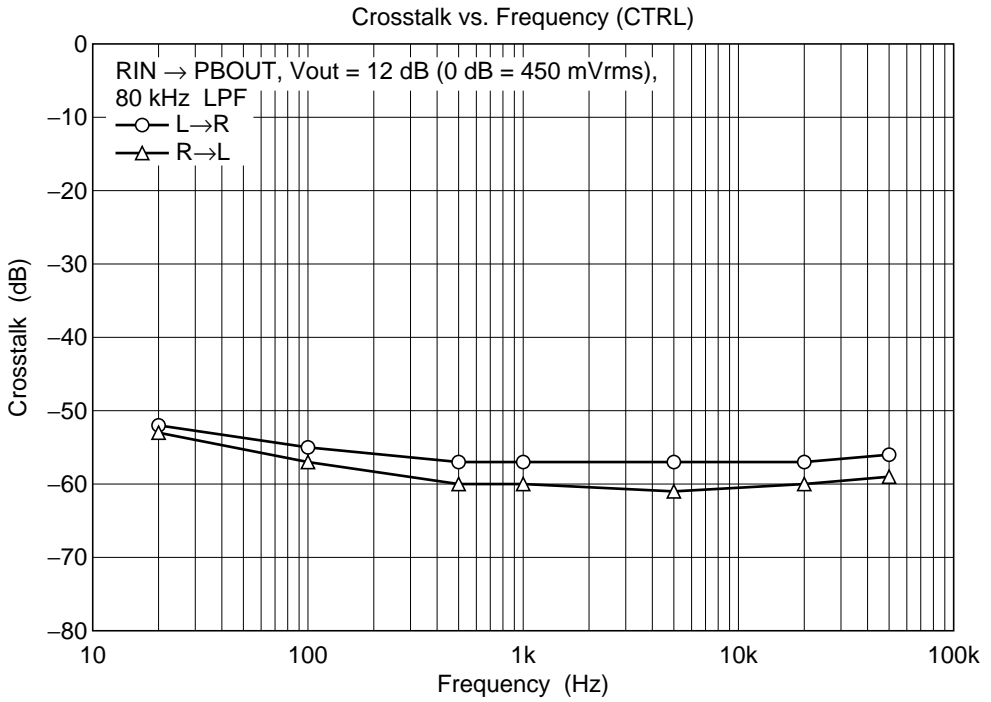

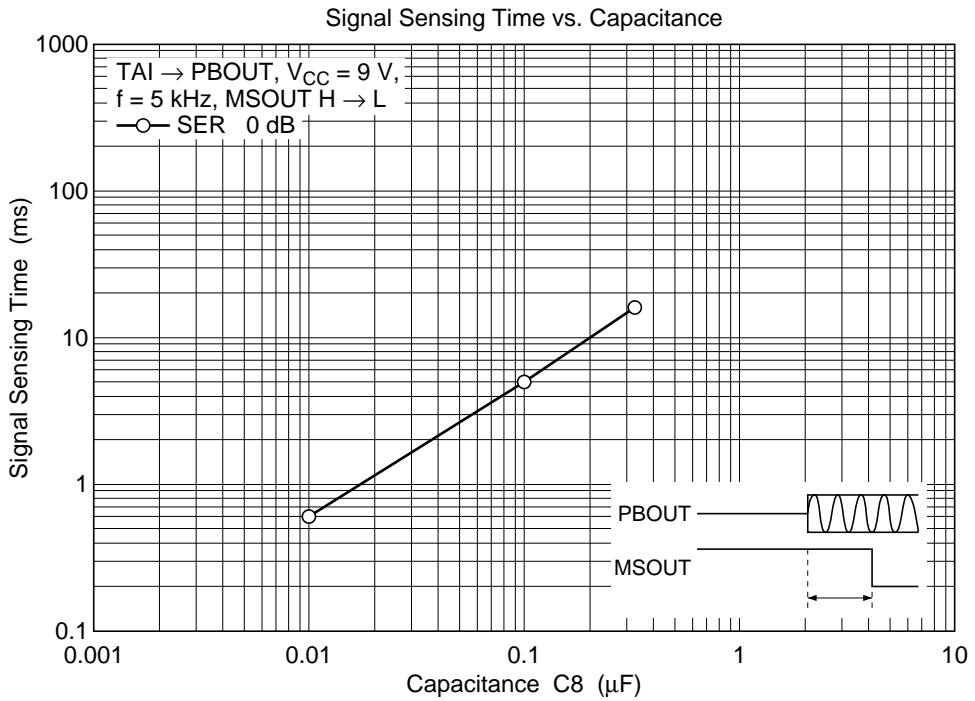
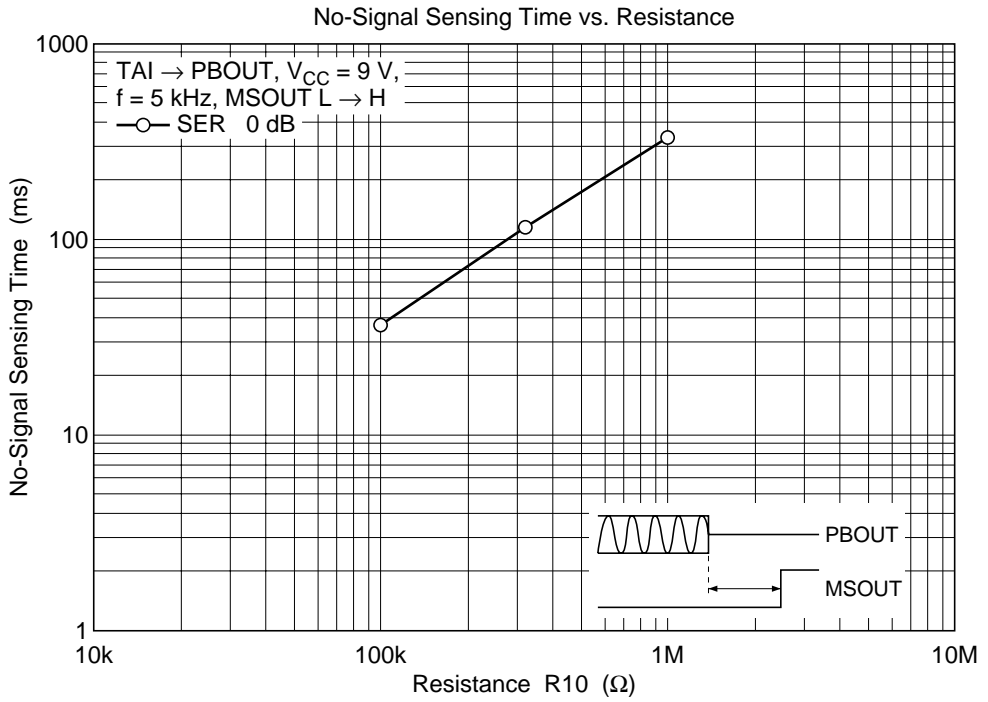

## Package Dimensions

Unit: mm

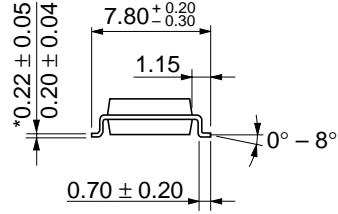
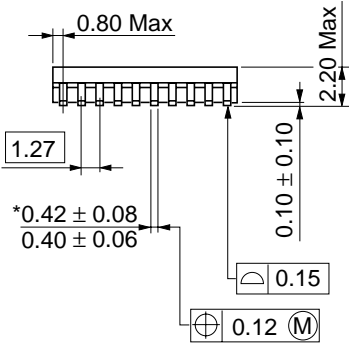
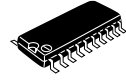
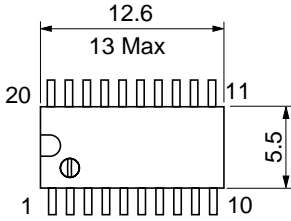

\*Dimension including the plating thickness  
Base material dimension

|                        |          |
|------------------------|----------|
| Hitachi Code           | FP-20DA  |
| JEDEC                  | —        |
| EIAJ                   | Conforms |
| Mass (reference value) | 0.31 g   |



## Cautions

1. Hitachi neither warrants nor grants licenses of any rights of Hitachi's or any third party's patent, copyright, trademark, or other intellectual property rights for information contained in this document. Hitachi bears no responsibility for problems that may arise with third party's rights, including intellectual property rights, in connection with use of the information contained in this document.
2. Products and product specifications may be subject to change without notice. Confirm that you have received the latest product standards or specifications before final design, purchase or use.
3. Hitachi makes every attempt to ensure that its products are of high quality and reliability. However, contact Hitachi's sales office before using the product in an application that demands especially high quality and reliability or where its failure or malfunction may directly threaten human life or cause risk of bodily injury, such as aerospace, aeronautics, nuclear power, combustion control, transportation, traffic, safety equipment or medical equipment for life support.
4. Design your application so that the product is used within the ranges guaranteed by Hitachi particularly for maximum rating, operating supply voltage range, heat radiation characteristics, installation conditions and other characteristics. Hitachi bears no responsibility for failure or damage when used beyond the guaranteed ranges. Even within the guaranteed ranges, consider normally foreseeable failure rates or failure modes in semiconductor devices and employ systemic measures such as fail-safes, so that the equipment incorporating Hitachi product does not cause bodily injury, fire or other consequential damage due to operation of the Hitachi product.
5. This product is not designed to be radiation resistant.
6. No one is permitted to reproduce or duplicate, in any form, the whole or part of this document without written approval from Hitachi.
7. Contact Hitachi's sales office for any questions regarding this document or Hitachi semiconductor products.

# HITACHI

## Hitachi, Ltd.

Semiconductor & Integrated Circuits.  
Nippon Bldg., 2-6-2, Ohte-machi, Chiyoda-ku, Tokyo 100-0004, Japan  
Tel: Tokyo (03) 3270-2111 Fax: (03) 3270-5109

|     |              |   |
|-----|--------------|---|
| URL | NorthAmerica | : <a href="http://semiconductor.hitachi.com/">http://semiconductor.hitachi.com/</a>           |
|     | Europe       | : <a href="http://www.hitachi-eu.com/hel/ecg">http://www.hitachi-eu.com/hel/ecg</a>           |
|     | Asia         | : <a href="http://sicapac.hitachi-asia.com">http://sicapac.hitachi-asia.com</a>               |
|     | Japan        | : <a href="http://www.hitachi.co.jp/Sicd/indx.htm">http://www.hitachi.co.jp/Sicd/indx.htm</a> |

### For further information write to:

Hitachi Semiconductor  
(America) Inc.  
179 East Tasman Drive,  
San Jose, CA 95134  
Tel: <1> (408) 433-1990  
Fax: <1> (408) 433-0223

Hitachi Europe GmbH  
Electronic Components Group  
Dornacher StraÙe 3  
D-85622 Feldkirchen, Munich  
Germany  
Tel: <49> (89) 9 9180-0  
Fax: <49> (89) 9 29 30 00

Hitachi Europe Ltd.  
Electronic Components Group.  
Whitebrook Park  
Lower Cookham Road  
Maidenhead  
Berkshire SL6 8YA, United Kingdom  
Tel: <44> (1628) 585000  
Fax: <44> (1628) 585160

Hitachi Asia Ltd.  
Hitachi Tower  
16 Collyer Quay #20-00,  
Singapore 049318  
Tel: <65>-538-6533/538-8577  
Fax : <65>-538-6933/538-3877  
URL : <http://www.hitachi.com.sg>

Hitachi Asia Ltd.  
(Taipei Branch Office)  
4/F, No. 167, Tun Hwa North Road,  
Hung-Kuo Building,  
Taipei (105), Taiwan  
Tel: <886>-(2)-2718-3666  
Fax : <886>-(2)-2718-8180  
Telex : 23222 HAS-TP  
URL : <http://www.hitachi.com.tw>

Hitachi Asia (Hong Kong) Ltd.  
Group III (Electronic Components)  
7/F., North Tower,  
World Finance Centre,  
Harbour City, Canton Road  
Tsim Sha Tsui, Kowloon,  
Hong Kong  
Tel : <852>-(2)-735-9218  
Fax : <852>-(2)-730-0281  
URL : <http://www.hitachi.com.hk>

Copyright © Hitachi, Ltd., 2001. All rights reserved. Printed in Japan.  
Colophon 2.0

## HITACHI