

SD Memory Card Connectors

DM1 Series

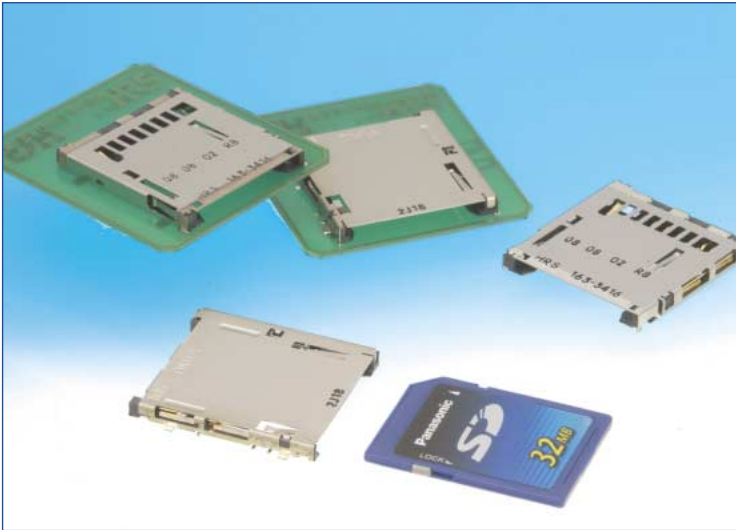

■ Features

1. Withstands higher force of card insertion

Metal cover extends over the back of the connector allowing it to withstand force of up to 400 N (static load) when dropped or accidentally hit.

2. No damage to the card when accidentally pulled-out

The connectors will release the card when a moderate pull-out force of about 4 N is applied. There will be no damage to the lock components and all connector functions will not be affected.

3. Accidental card fall-out prevention

Built-in lock feature holds the card securely in place.

4. Reliable Card Insertion and Withdrawal

Built-in Push-in / Push-out ejection mechanism assures simple and reliable card insertion and withdrawal.

5. Designed to accept Secure Digital I/O card (Built-in Ground Contact)

The connector allows use of various expansion modules, including the Bluetooth communication modules.

■ Applications

Notebook PC's, digital cameras, PDA's, audio/video equipment and other devices utilizing SD I/O cards.

Withstands higher force of card insertion.

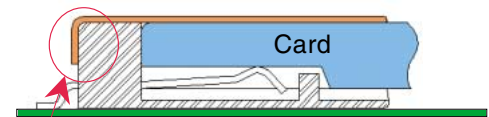

Standard type

Metal cover extends over the back of the connector.

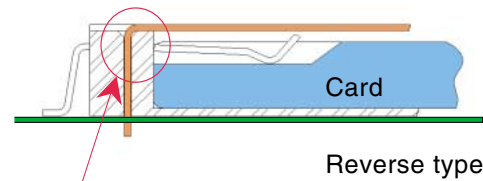

Reverse type

Metal cover extends over the back of the connector.

No damage to the card when accidentally pulled-out.

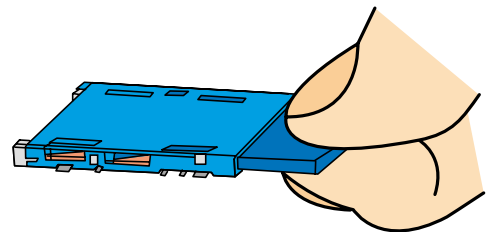

Accidental card fall-out prevention

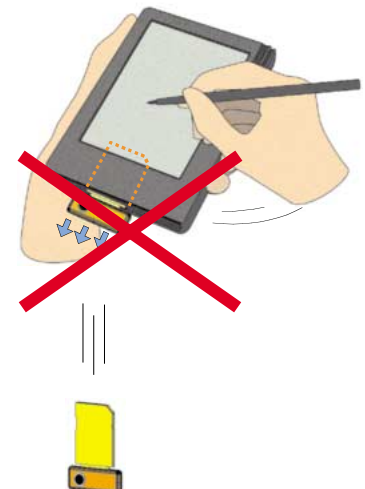

Product Specifications

Rating	Current rating 0.5A DC Voltage rating 125 V AC	Operating temperature range:-25°C to +85°C (Note 1) Storage temperature range:-40°C to +85°C (Note 2)	Operating humidity range : Relative humidity 95% max. (No condensation)
--------	---	--	--

Item	Specification	Conditions
1. Insulation resistance	1000 M ohms min. (Initial value)	500 V DC
2. Withstanding voltage	No flashover or insulation breakdown	500 V AC / one minute
3. Contact resistance	100 m ohms max. (Initial value)	100mA DC
4. Vibration	No electrical discontinuity of 100 ns or more	Frequency: 10 to 55 Hz, single amplitude of 0.75 mm, 2 hours / 3 axis
5. Humidity	Contact resistance: 40 m ohms max. from initial value Insulation resistance: 100 M ohms min.	96 hours at temperature of 40°C ± 2°C and humidity of 90% to 95%
6. Temperature cycle	Contact resistance: 40 m ohms max. from initial value Insulation resistance: 100 M ohms min.	Temperature: -55°C → +5°C to +35°C → +85°C → +5°C to +35°C Duration: 30 → 5 → 30 → 5 (Minutes) 5 cycles
7. Durability (mating/un-mating)	Contact resistance: 40m ohms max. from initial value	10000 cycles at 400 to 600 cycles per hour
8. Resistance to soldering heat	No deformation of components affecting performance.	Reflow: At the recommended temperature profile Manual soldering: 300°C for 3 seconds

Note1: Includes temperature rise caused by current flow.

Note2: The term "storage" refers to products stored for long period of time prior to mounting and use. Operating Temperature Range and Humidity range covers non- conducting condition of installed connectors in storage, shipment or during transportation.

Materials

Component	Material	Finish	Remarks
Insulator	Heat resistant thermoplastic compound	Color: Black	UL94V-0
Contacts	Phosphor bronze	Contact area: Gold plating Termination area: Tinned copper plating	_____
Cover	Stainless steel	Termination area: Tinned copper plating	_____
Others	Stainless steel Piano wire	_____ Nickel plating	_____

Ordering information

DM1 AA - SF - PEJ

① ② ③ ④

① Series name	DM1	③ Terminal type	SF : Right angle surface mount
② Connector type	AA : Standard receptacle B : Reverse receptacle		DSF : Reverse right angle surface mount
		④ Eject mechanism codes	PEJ : Card Push insert/Push withdraw

Standard type



Part number	HRS No.
DM1AA-SF-PEJ(21)	609-0004-8-21

PCB mounting pattern

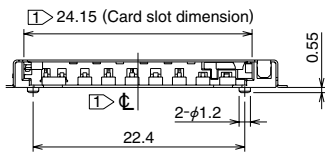
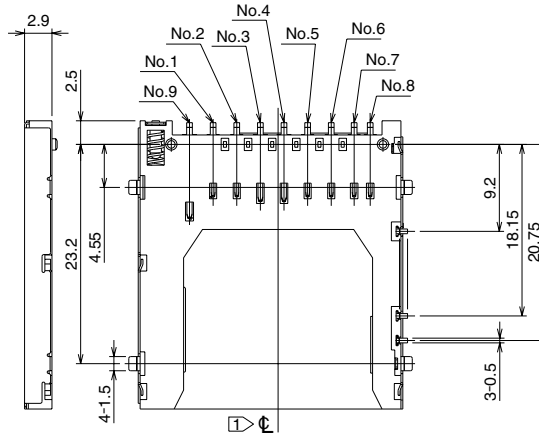
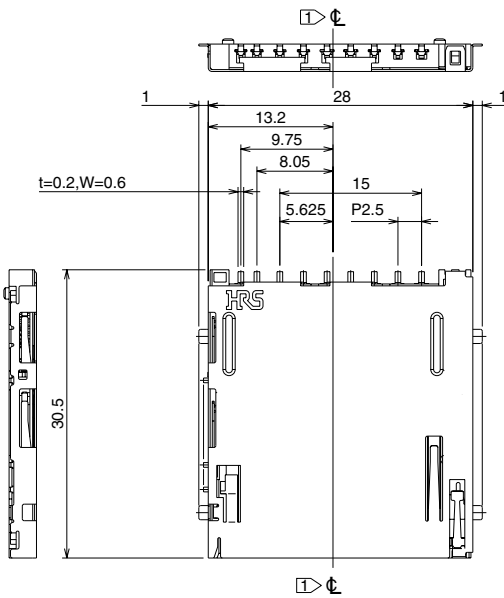
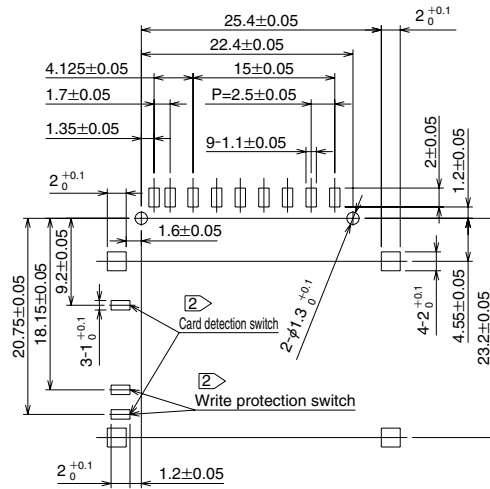

① indicates the center line of card slot.

Card detection switch		Write protection switch		
When card is ejected	When card is inserted	When card is ejected	When card is inserted	
		WRITE PROTECT	WRITE ENABLE	
OPEN	CLOSE	OPEN	OPEN	CLOSE

Weight:2.2g

Card insertion/withdrawal dimensions

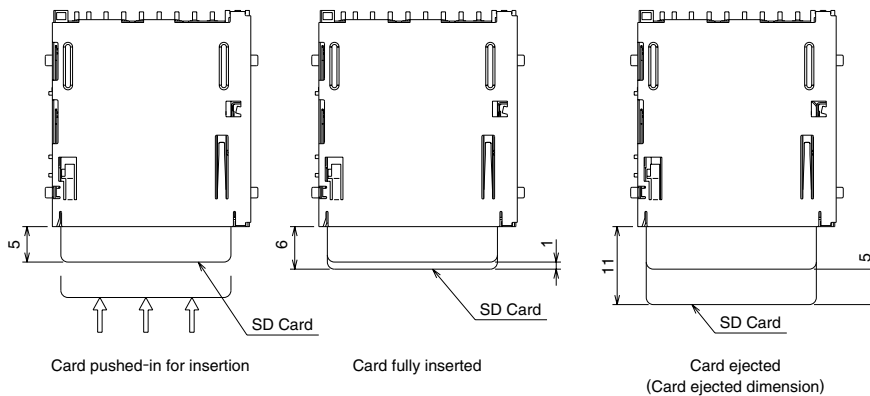

Reverse type

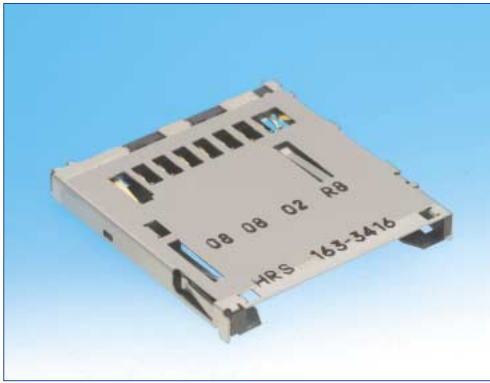

Part number	HRS No.
DM1B-DSF-PEJ	609-0003-5

PCB mounting pattern

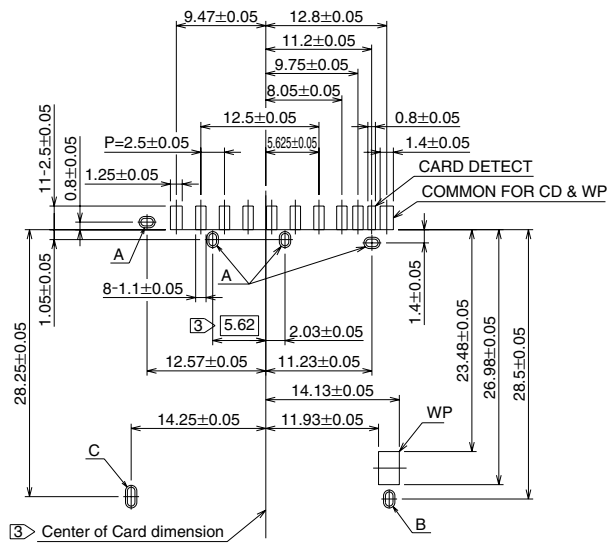

A(5:1)

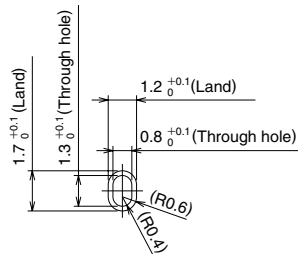

B(5:1)

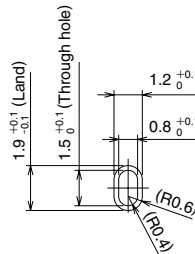

C(5:1)

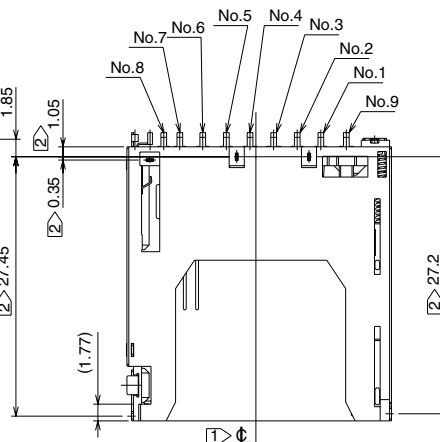
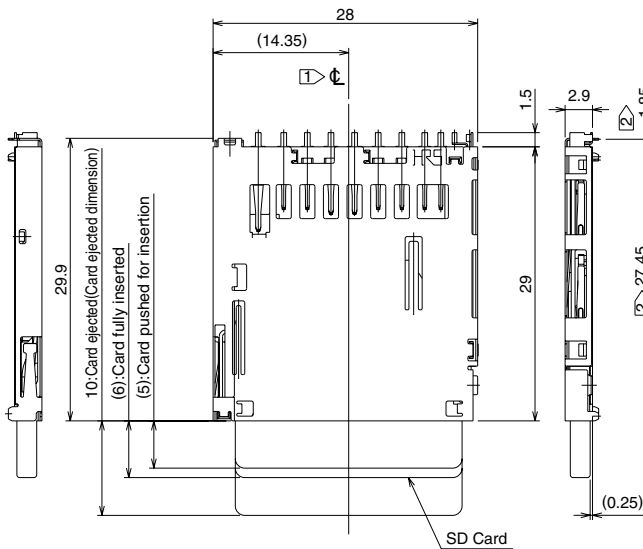
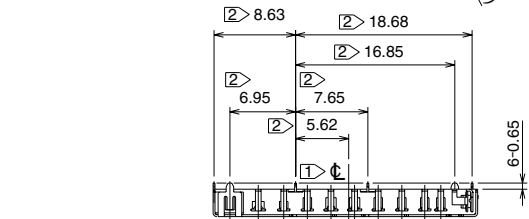
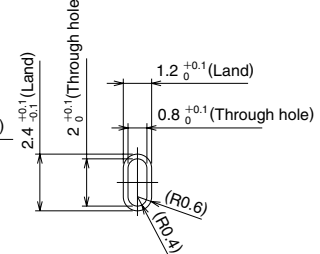

- ① ⌀ Indicates the center line of the card slot.
 ② Indicates the dimension of DIP terminals.

Card detection switch		Write protection switch		
When card is ejected	When card is ejected	When card is ejected	When card is ejected	When card is ejected
		WRITE PROTECT	WRITE ENABLE	
OPEN	CLOSE	OPEN	OPEN	CLOSE

Weight: 2.1g

◆ Packaging specifications

● Embossed Carrier Tape Dimensions (Standard type) 450 pieces per reel

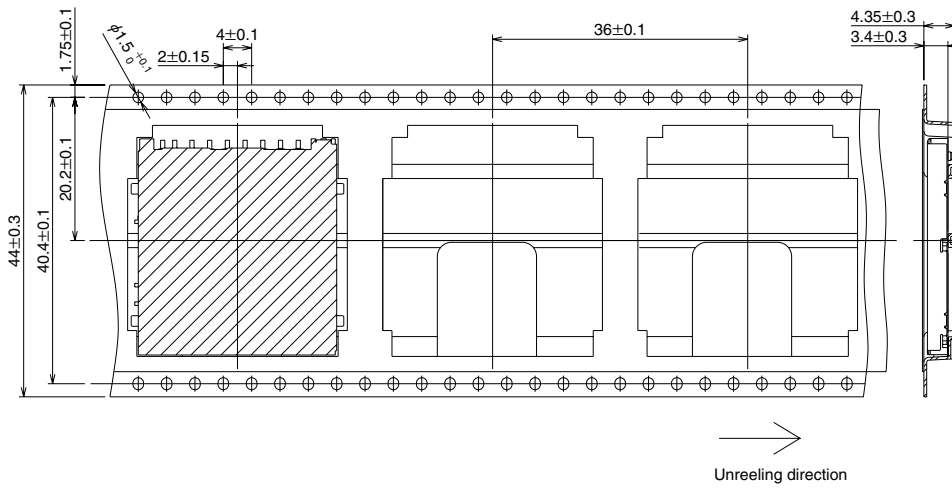

● Embossed Carrier Tape Dimensions (Reverse type) 450 pieces per reel

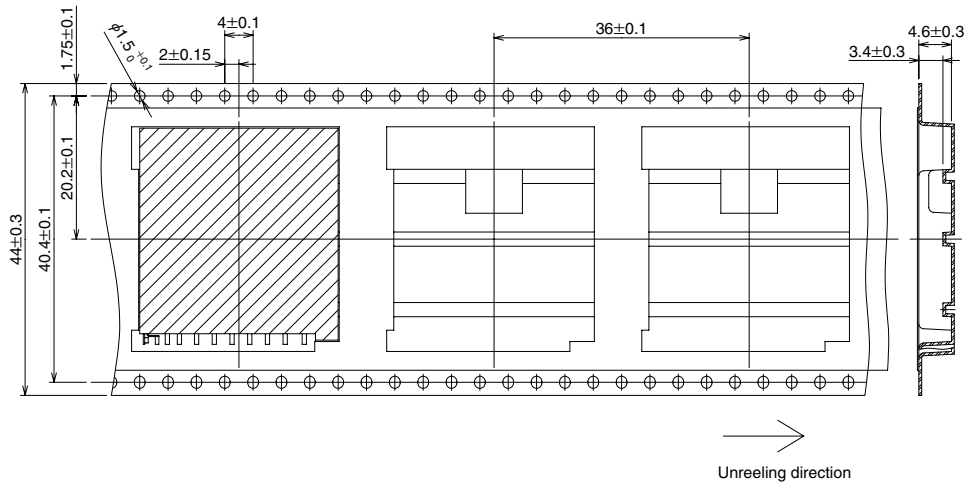

● Reel dimensions

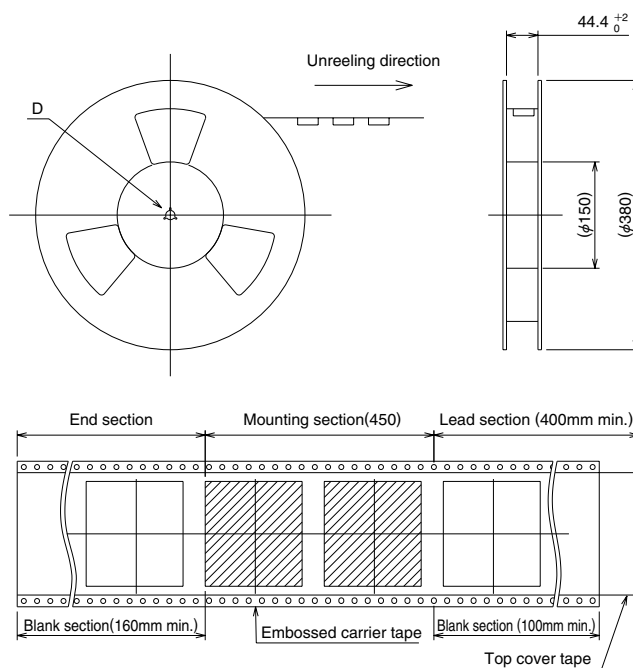

■ Recommended Temperature Profile

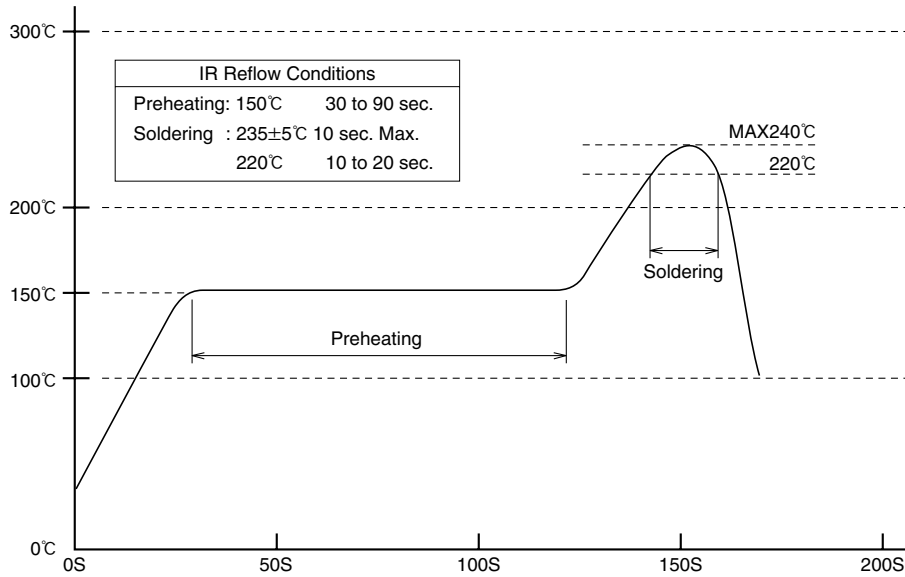

Recommended Conditions

Reflow system : IR reflow
Solder : Paste type 63 Sn/37 Pb(Flux content 9 wt%)
Test board : Glass epoxy 60mm x 100mm x 1.6 mm thick
Metal mask thickness: 0.15 mm

Recommended temperature profile.

The temperature may be slightly changed according to the solder paste type and thickness.