

8-bit Proprietary Microcontroller

CMOS

F²MC-8L MB89150/150A Series

**MB89151/151A/152/152A/153/153A/154/154A/155/155A
MB89P155/PV150**

DESCRIPTION

The MB89150/A series has been developed as general-purpose version of the F²MC*-8L family consisting of proprietary 8-bit, single-chip microcontrollers.

In addition to a compact instruction set, the MB89150 series microcontrollers contain a variety of peripheral functions such as dual-clock control system, five operating speed control stages, timers, a serial interface, a remote control transmission output, external interrupts, an LCD controller/driver, an LCD booster, and a watch prescaler.

*: F²MC stands for FUJITSU Flexible Microcontroller.

FEATURES

- F²MC-8L family CPU core
- Dual-clock system
- High-speed processing at low voltage
- Minimum execution time: 0.95 μ s/2.7 V, 1.33 μ s/2.2 V
- I/O ports: max. 43 channels
- 21-bit time-base timer
- 8/16-bit timer/counter: 1 channel (8 bits \times 2 channels)
- 8-bit serial I/O: 1 channel
- LCD controller/driver: Max. 36 segments \times 4 commons (built-in booster)
- Remote control transmission output

(Continued)

PACKAGE

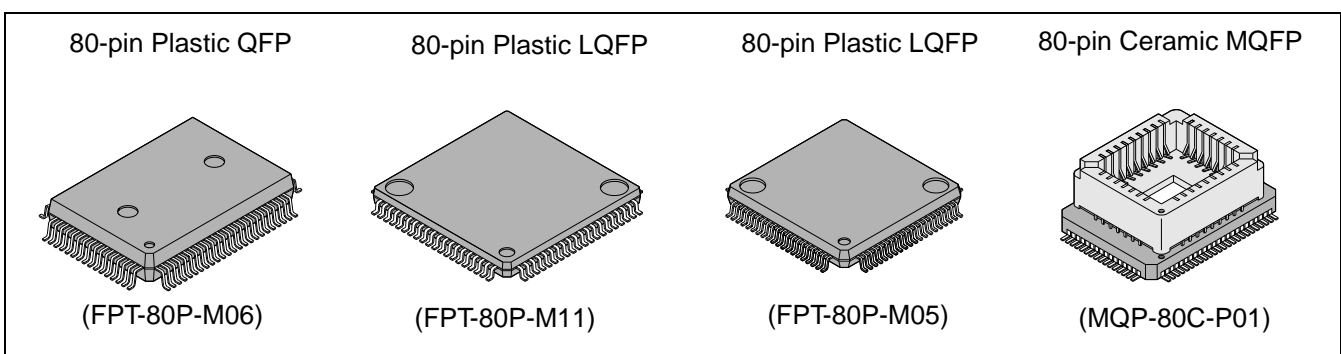

MB89150/150A Series

(Continued)

- Buzzer output
- Watch prescaler (15 bits)
- External interrupts (wake-up function)

Four independent channels with edge detection function plus eight level-interrupt channels

■ PRODUCT LINEUP

Part number Parameter	MB89151/A	MB89152/A	MB89153/A	MB89154/A	MB89155/A	MB89P155	MB89PV150
Classification	Mass production products (mask ROM products)					One-time PROM product	Piggyback/ evaluation product (for evaluation and development)
ROM size	4 K × 8 bits (internal mask ROM)	6 K × 8 bits (internal mask ROM)	8 K × 8 bits (internal mask ROM)	12 K × 8 bits (internal mask ROM)	16 K × 8 bits (internal mask ROM)	16 K × 8 bits (internal PROM, programming with general- purpose EPROM programmer)	32 K × 8 bits (external ROM)
RAM size	128 × 8 bits	256 × 8 bits					512 × 8 bits
CPU functions	Number of instructions: 136 Instruction bit length: 8 bits Instruction length: 1 to 3 bytes Data bit length: 1, 8, 16 bits Minimum execution time: 0.95 μs/4.2 MHz Interrupt processing time: 8.57 μs/4.2 MHz						
Ports	I/O port (N-ch open-drain): 8 (6 ports also serve as peripherals, 3 ports are a high-current drive type.) Output port (N-ch open-drain): 18 (16 ports also serve as segment pins, 2 ports serve as boost capacitor connection pins.) ^{*1} I/O port (CMOS): 16 (12 ports also serve as an external interrupt.) Output port (CMOS): 1 (Also serves as a remote control.) Total: 43 (max.)						
Timer/counter	8-bit timer counter × 2 channel or 16-bit event counter × 1 channel						
8-bit serial I/O	8 bits LSB first/MSB first selectability						
LCD controller/ driver	Common output: 4 Segment output: 32 (max.) ^{*1} Bias power supply pins: 4 LCD display RAM size: 36 × 4 bits Booster for LCD driving: Built-in ^{*1} Dividing resistor for LCD driving: Built-in (an external resistor selectability)					No reference voltage generator and booster for LCD driving	
External interrupts (wake-up function)	4 (edge selectability) 8 (level interrupt only)						
Buzzer output	1 (7 frequencies are selectable by the software.)						

(Continued)

MB89150/150A Series

(Continued)

Part number Parameter	MB89151/A	MB89152/A	MB89153/A	MB89154/A	MB89155/A	MB89P155	MB89PV150
Remote control transmission output	1 (Pulse width and cycle are software selectable.)						
Standby modes	Sleep mode, stop mode, and watch mode						
Process	CMOS						
Operating voltage ²	2.2 V to 6.0 V (single clock)/2.2 V to 4.0 V (dual clock)					2.7 V to 6.0 V	
EPROM for use							MBM27C256A -20TV (LCC package)

*1: Selected by the mask option. See section “■ Mask Options.”

*2: Varies with conditions such as the operating frequency and the connected ICE. (See section “■ Electrical Characteristics.”)

■ PACKAGE AND CORRESPONDING PRODUCTS

Package	MB89151/A MB89152/A MB89153/A MB89154/A MB89155/A	MB89P155	MB89PV150
FPT-80P-M06	○	○	×
FPT-80P-M11	○	○	×
FPT-80P-M05	○	○	×
MQP-80C-P01	×	×	○

○ : Available × : Not available

Note: For more information about each package, see section “■ Package Dimensions.”

MB89150/150A Series

■ DIFFERENCES AMONG PRODUCTS

1. Memory Size

Before evaluating using the piggyback product, verify its differences from the product that will actually be used. Take particular care on the following points:

- On the MB89151/A, addresses 0140_H and later of the register bank cannot be used. On the MB89152/A, 153/A, 154/A, 155/A, and MB89P155, addresses 0180_H and later of each register bank cannot be used.
- On the MB89P155, addresses BFF0_H to BFF6_H comprise the option setting area, option settings can be read by reading these addresses.
- The stack area, etc., is set at the upper limit of the RAM.

2. Current Consumption

- In the case of the MB89PV150, add the current consumed by the EPROM which is connected to the top socket.
- When operated at low speed, the product with an OTPROM (one-time PROM) or an EPROM will consume more current than the product with a mask ROM.

However, the current consumption in sleep/stop modes is the same. (For more information, see sections “■ Electrical Characteristics” and “■ Example Characteristics.”)

3. Mask Options

Functions that can be selected as options and how to designate these options vary by the product.

Before using options check section “■ Mask Options.”

Take particular care on the following point:

- On the MB89PV150, options are fixed, except for the segment output selection.

PIN ASSIGNMENT

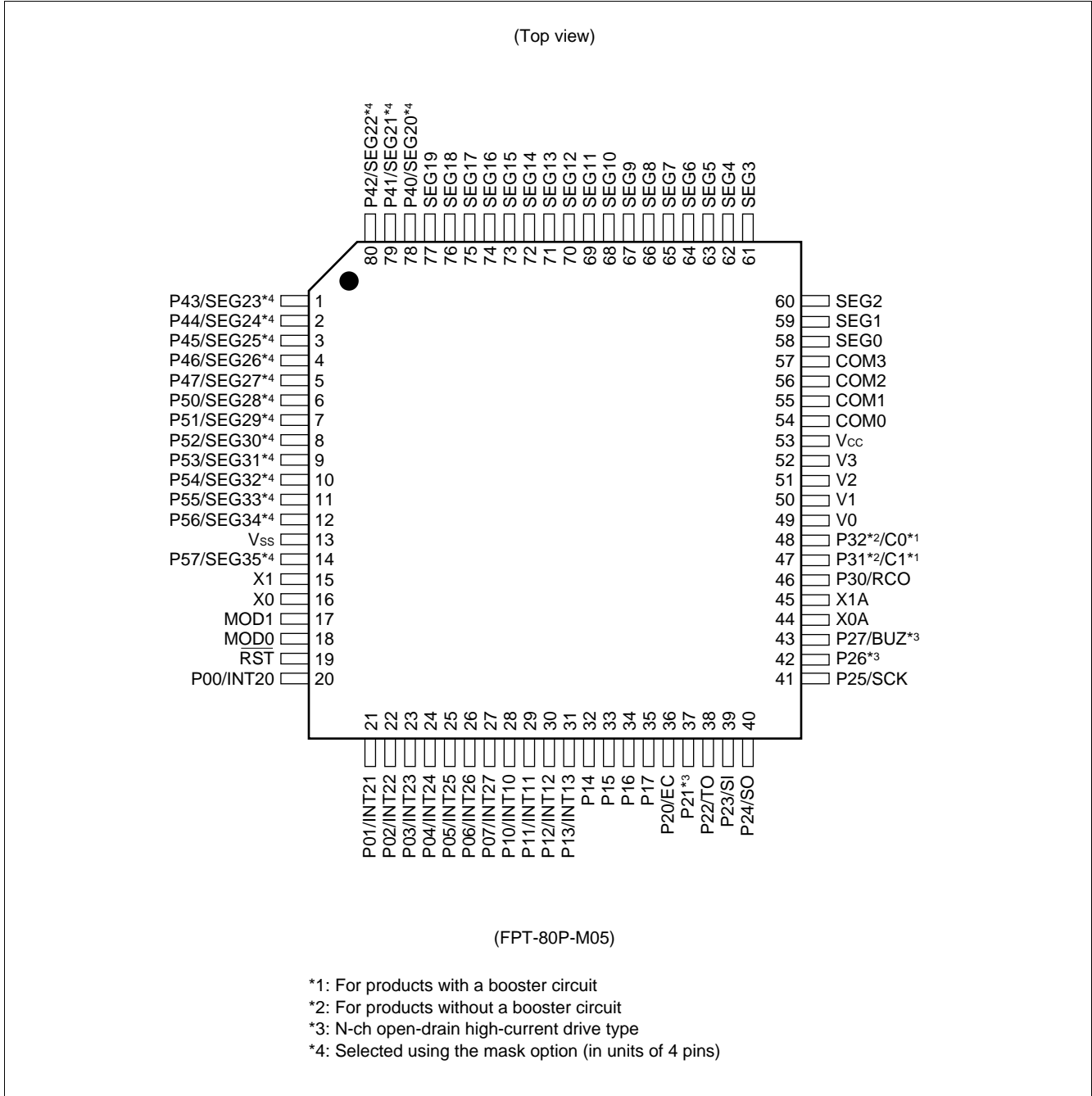

MB89150/150A Series

(Top view)

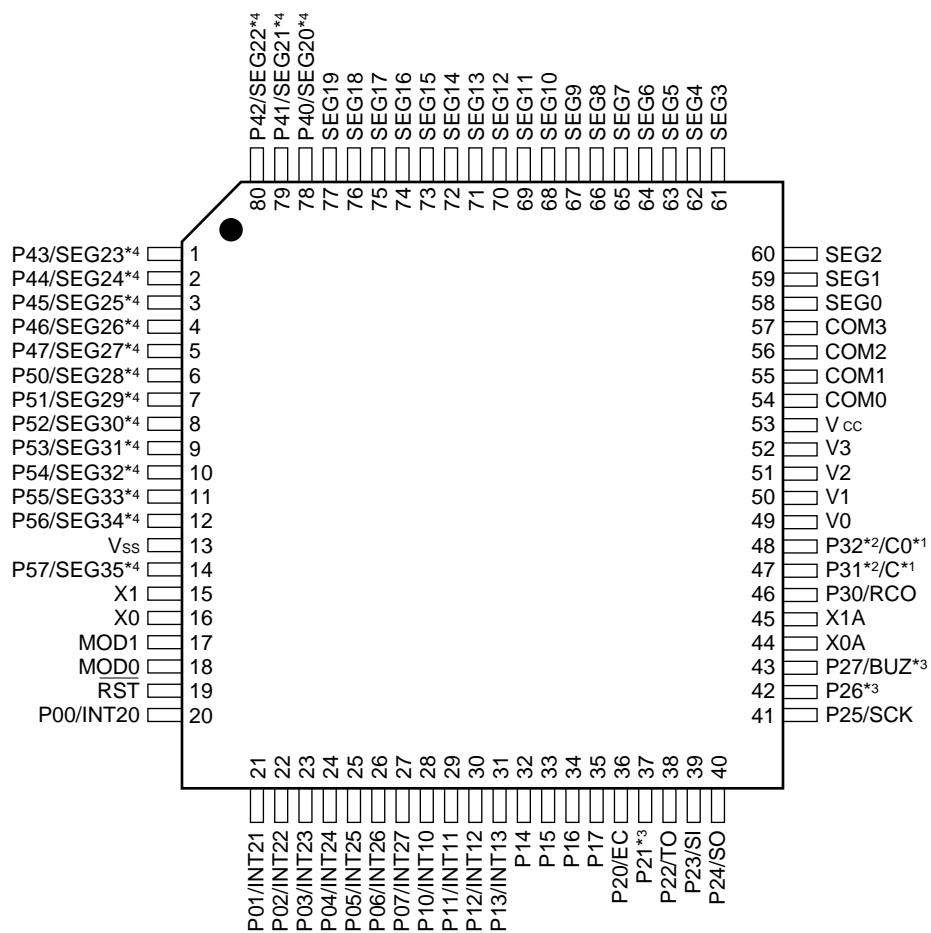

(FPT-80P-M11)

- *1: For products with a booster circuit
- *2: For products without a booster circuit
- *3: N-ch open-drain high-current drive type
- *4: Selected using the mask option (in units of 4 pins)

MB89150/150A Series

(Top view)

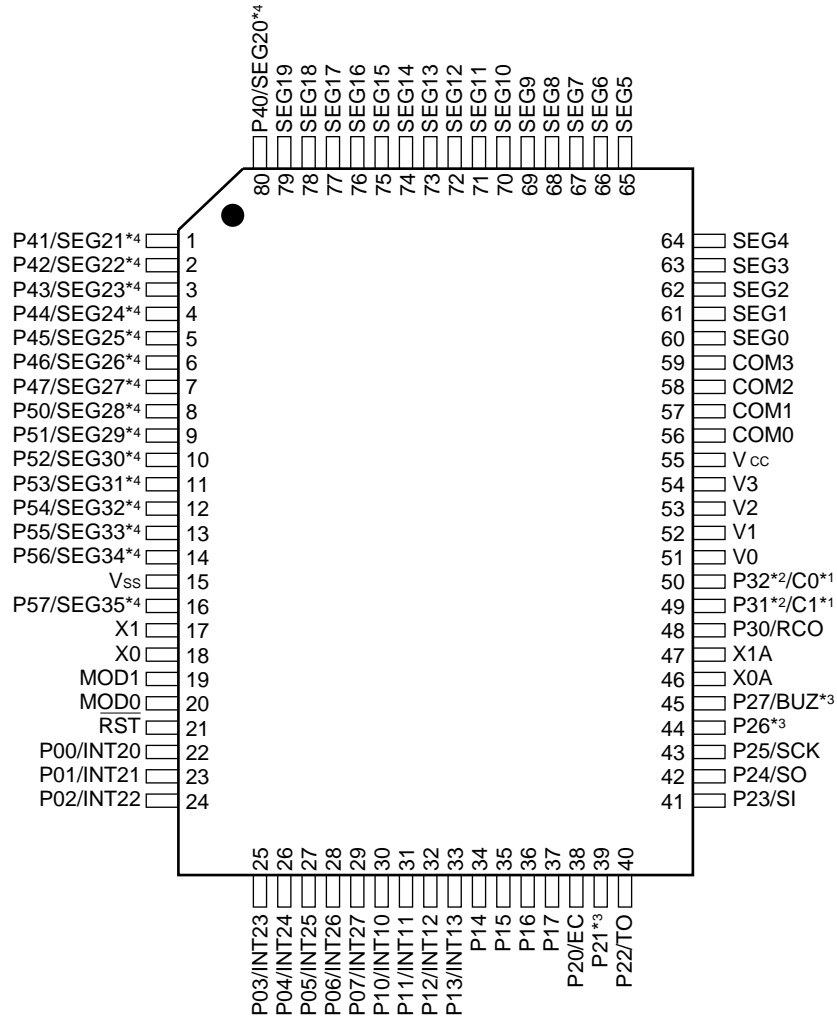

(FPT-80P-M06)

- *1: For products with a booster circuit
- *2: For products without a booster circuit
- *3: N-ch open-drain high-current drive type
- *4: Selected using the mask option (in units of 4 pins)

MB89150/150A Series

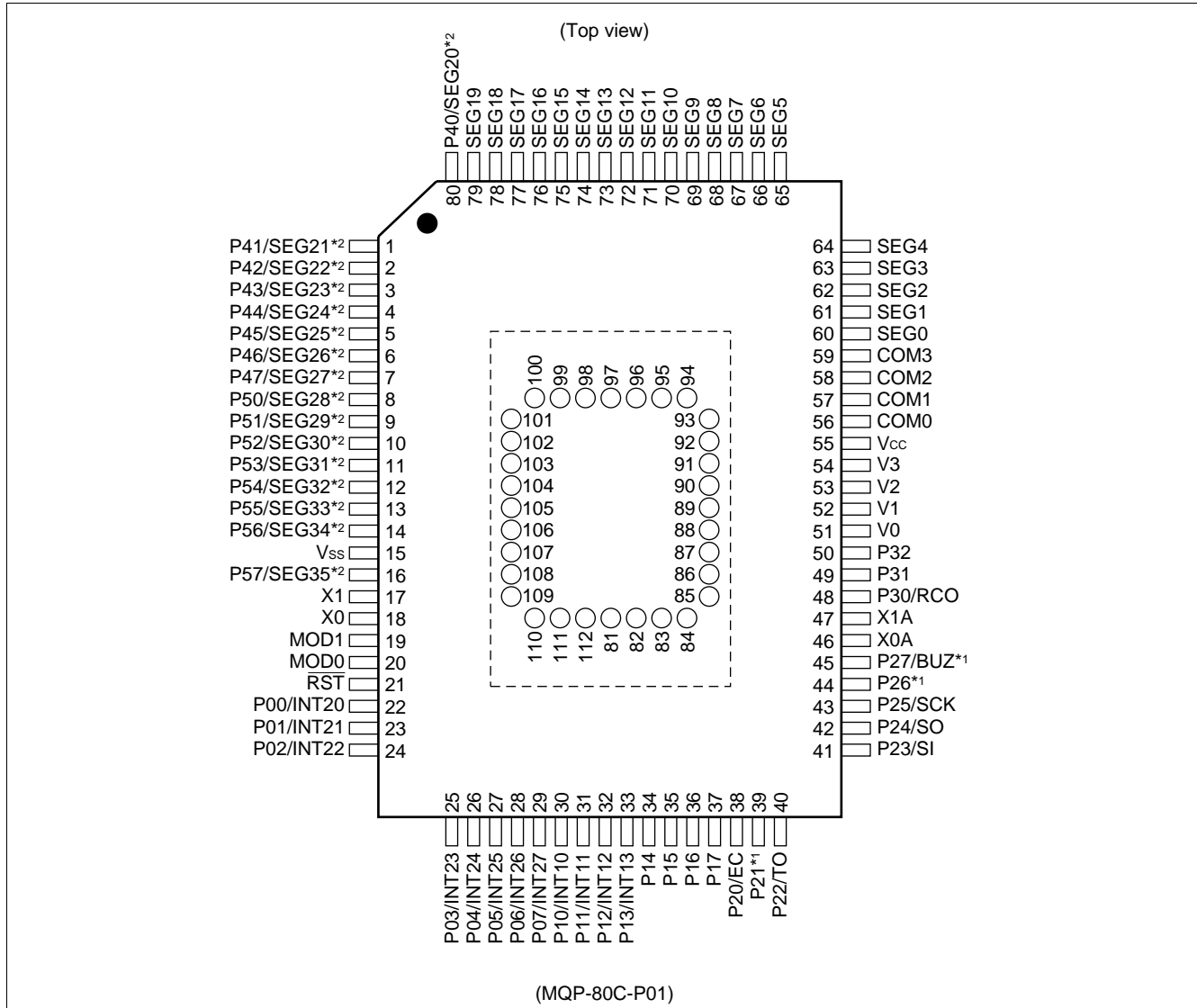

*1: N-ch open-drain high-current drive type
 *2: Selected using the mask option (in units of 4 pins).

• Pin assignment on package top

Pin no.	Pin name	Pin no.	Pin name	Pin no.	Pin name	Pin no.	Pin name
81	N.C.	89	A2	97	N.C.	105	\overline{OE}
82	V _{PP}	90	A1	98	O4	106	N.C.
83	A12	91	A0	99	O5	107	A11
84	A7	92	N.C.	100	O6	108	A9
85	A6	93	O1	101	O7	109	A8
86	A5	94	O2	102	O8	110	A13
87	A4	95	O3	103	\overline{CE}	111	A14
88	A3	96	V _{SS}	104	A10	112	V _{CC}

N.C.: Internally connected. Do not use.

MB89150/150A Series

■ PIN DESCRIPTION

Pin no.		Pin name	Circuit type	Function
LQFP ^{*1,3}	MQFP ^{*4} QFP ^{*2}			
16	18	X0	A	Main clock oscillator pins
15	17	X1		
18	20	MOD0	C	Operating mode selection pins Connect directly to V _{ss} .
17	19	MOD1		
19	21	RST	D	Reset I/O pin This pin is an N-ch open-drain output type with a pull-up resistor and a hysteresis input type. "L" is output from this pin by an internal reset source. The internal circuit is initialized by the input of "L".
20 to 27	22 to 29	P00/INT20 to P07/INT27	E	General-purpose I/O ports Also serve as an external interrupt 2 input (wake-up function). External interrupt 2 input is hysteresis input.
28 to 31	30 to 33	P10/INT10 to P13/INT13	E	General-purpose I/O ports Also serve as external interrupt 1 input. External interrupt 1 input is hysteresis input.
32 to 35	34 to 37	P14 to P17	F	General-purpose I/O ports
36	38	P20/EC	H	N-ch open-drain general-purpose I/O port Also serves as the external clock input for the timer. The peripheral is a hysteresis input type.
37	39	P21	I	N-ch open-drain general-purpose I/O port
38	40	P22/TO	I	N-ch open-drain general-purpose I/O port Also serves as a timer output.
39	41	P23/SI	H	N-ch open-drain general-purpose I/O port Also serves as the data input for the 8-bit serial I/O. The peripheral is a hysteresis input type.
40	42	P24/SO	I	N-ch open-drain general-purpose I/O port Also serves as the data output for the 8-bit serial I/O.
41	43	P25/SCK	H	N-ch open-drain general-purpose I/O port Also serves as the clock I/O for the 8-bit serial I/O. The peripheral is a hysteresis input type.
42	44	P26	I	N-ch open-drain general-purpose I/O port
43	45	P27/BUZ	I	N-ch open-drain general-purpose I/O port Also serves as a buzzer output.

- *1: FPT-80P-M11
- *2: FPT-80P-M06
- *3: FPT-80P-M05
- *4: MQP-80C-P01

(Continued)

MB89150/150A Series

(Continued)

Pin no.		Pin name	Circuit type	Function
LQFP*1*3	MQFP*4 QFP*2			
48	50	P32	J	Functions as an N-ch open-drain general-purpose output port only in the products without a booster.
		C0	—	Functions as a capacitor connection pin in the products with a booster.
47	49	P31	J	Functions as an N-ch open-drain general-purpose output port only in the products without a booster.
		C1	—	Functions as a capacitor connection pin in the products with a booster.
46	48	P30/RCO	G	General-purpose output-only port Also serves as a remote control transmission output.
14	16	P57/SEG35	J/K	N-ch open-drain general-purpose output ports Also serve as LCD controller/driver segment output. Switching between port and common output is done by the mask option.
12 to 6	14 to 8	P56/SEG34 to P50/SEG28		
5 to 1	7 to 3	P47/SEG27 to P43/SEG23		
80, 79, 78	2, 1, 80	P42/SEG22, P41/SEG21, P40/SEG20	J/K	
77 to 58	79 to 60	SEG19 to SEG0	K	LCD controller/driver segment output-only pins
57 to 54	59 to 56	COM3 to COM0	K	LCD controller/driver common output-only pins
52 to 49	54 to 51	V3 to V0	—	LCD driving power supply pins
44	46	X0A	B	Subclock crystal oscillator pins (32.768 kHz)
45	47	X1A		
53	55	V _{CC}	—	Power supply pin
13	15	V _{SS}	—	Power supply (GND) pin

*1: FPT-80P-M11

*2: FPT-80P-M06

*3: FPT-80P-M05

*4: MQP-80C-P01

MB89150/150A Series

- External EPROM pins (MB89PV150 only)

Pin no.	Pin name	I/O	Function
82	V _{PP}	O	"H" level output pin
83	A12	O	Address output pins
84	A7		
85	A6		
86	A5		
87	A4		
88	A3		
89	A2		
90	A1		
91	A0		
93	O1	I	Data input pins
94	O2		
95	O3		
96	V _{SS}	O	Power supply (GND) pin
98	O4	I	Data input pins
99	O5		
100	O6		
101	O7		
102	O8		
103	\overline{CE}		
104	A10	O	Address output pin
105	\overline{OE}	O	ROM output enable pin Outputs "L" at all times.
107	A11	O	Address output pins
108	A9		
109	A8		
110	A13		
111	A14	O	
112	V _{CC}	O	EPROM power supply pin
81	N.C.	—	Internally connected pins Be sure to leave them open.
92			
97			
106			

MB89150/150A Series

■ I/O CIRCUIT TYPE

Type	Circuit	Remarks
A	<p>Standby control signal</p>	Crystal or ceramic oscillation type (main clock) <ul style="list-style-type: none"> At an oscillation feedback resistor of approximately 1 MΩ/5.0 V
	<p>Standby control signal</p>	CR oscillation type (main clock) (except MB89PV150/P155)
B	<p>Standby control signal</p>	Crystal oscillation type (subclock) <ul style="list-style-type: none"> At an oscillation feedback resistor of approximately 4.5 MΩ/3.0 V
C		
D		<ul style="list-style-type: none"> At output pull-up resistor (P-ch) of approximately 50 kΩ/5.0 V Hysteresis input
E		<ul style="list-style-type: none"> CMOS I/O The peripheral is a hysteresis input type. Pull-up resistor optional (except MB89PV150)

(Continued)

MB89150/150A Series

(Continued)

Type	Circuit	Remarks
F		<ul style="list-style-type: none"> • CMOS I/O • Pull-up resistor optional (except MB89PV150)
G		<ul style="list-style-type: none"> • CMOS output • P-ch output is a high-current drive type.
H		<ul style="list-style-type: none"> • N-ch open-drain I/O • CMOS input • The peripheral is a hysteresis input type. • Pull-up resistor optional (except MB89PV150/P155)
I		<ul style="list-style-type: none"> • N-ch open-drain I/O • CMOS input • P21, P26, and P27 are a high-current drive type. • Pull-up resistor optional (except MB89PV150/P155)
J		<ul style="list-style-type: none"> • N-ch open-drain output • Pull-up resistor optional (except MB89PV150/P155) • P31 and P32 are not provided with a pull-up resistor.
K		<ul style="list-style-type: none"> • LCD controller/driver segment output

MB89150/150A Series

■ HANDLING DEVICES

1. Preventing Latchup

Latchup may occur on CMOS ICs if voltage higher than V_{CC} or lower than V_{SS} is applied to input and output pins other than medium- to high-voltage pins or if higher than the voltage which shows on “1. Absolute Maximum Ratings” in section “■ Electrical Characteristics” is applied between V_{CC} and V_{SS} .

When latchup occurs, power supply current increases rapidly and might thermally damage elements. When using, take great care not to exceed the absolute maximum ratings.

Also, take care to prevent the analog power supply (AV_{CC} and AVR) and analog input from exceeding the digital power supply (V_{CC}) when the analog system power supply is turned on and off.

2. Treatment of Unused Input Pins

Leaving unused input pins open could cause malfunctions. They should be connected to a pull-up or pull-down resistor.

3. Treatment of Power Supply Pins on Microcontrollers with A/D and D/A Converters

Connect to be $AV_{CC} = DAVC = V_{CC}$ and $AV_{SS} = AVR = V_{SS}$ even if the A/D and D/A converters are not in use.

4. Treatment of N.C. Pins

Be sure to leave (internally connected) N.C. pins open.

5. Power Supply Voltage Fluctuations

Although V_{CC} power supply voltage is assured to operate within the rated range, a rapid fluctuation of the voltage could cause malfunctions, even if it occurs within the rated range. Stabilizing voltage supplied to the IC is therefore important. As stabilization guidelines, it is recommended to control power so that V_{CC} ripple fluctuations (P-P value) will be less than 10% of the standard V_{CC} value at the commercial frequency (50 to 60 Hz) and the transient fluctuation rate will be less than 0.1 V/ms at the time of a momentary fluctuation such as when power is switched.

6. Precautions when Using an External Clock

Even when an external clock is used, oscillation stabilization time is required for power-on reset (optional) and wake-up from stop mode.

■ PROGRAMMING TO THE EPROM ON THE MB89P155

The MB89P155 is an OTPROM version of the MB89150/A series.

1. Features

- 16-Kbyte PROM on chip
- Options can be set using the EPROM programmer.
- Equivalency to the MBM27C256A in EPROM mode (when programmed with the EPROM programmer)

2. Memory Space

Memory space in the EPROM mode is diagrammed below.

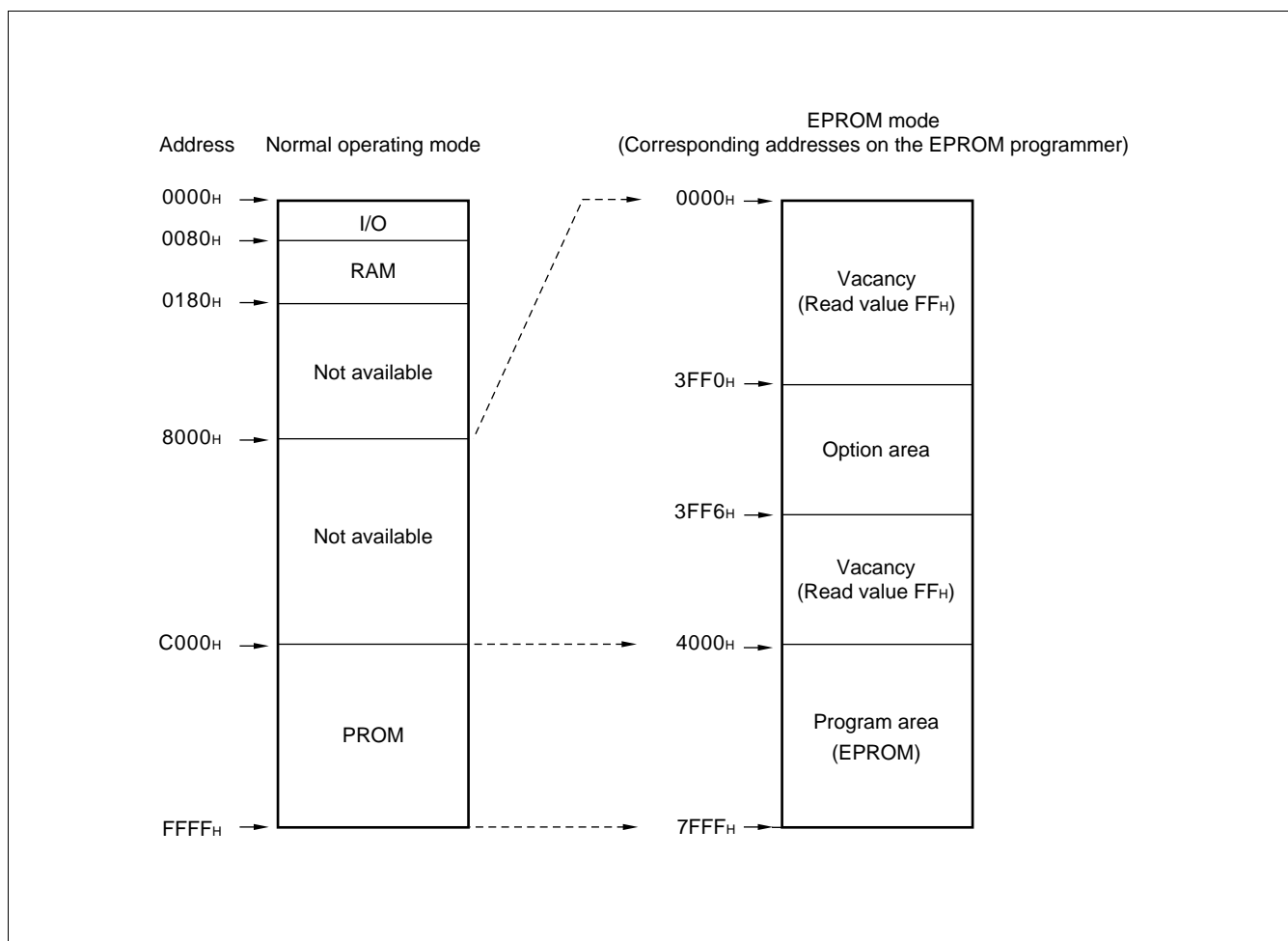

MB89150/150A Series

3. Programming to the EPROM

In EPROM mode, the MB89P155 functions equivalent to the MBM27C256A. This allows the PROM to be programmed with a general-purpose EPROM programmer (the electronic signature mode cannot be used) by using the dedicated socket adapter.

• Programming procedure

- (1) Set the EPROM programmer to the MBM27C256A.
- (2) Load program data into the EPROM programmer at 4000_H to 7FFF_H (note that addresses C000_H to FFFF_H while operating as a normal operating mode assign to 4000_H to 7FFF_H in EPROM mode).
Load option data into addresses 3FF0_H to 3FF5_H of the EPROM programmer. (For information about each corresponding option, see "7. Setting OTPROM Options.")
- (3) Program with the EPROM programmer.

4. Recommended Screening Conditions

High-temperature aging is recommended as the pre-assembly screening procedure for a product with a blanked OTPROM microcomputer program.

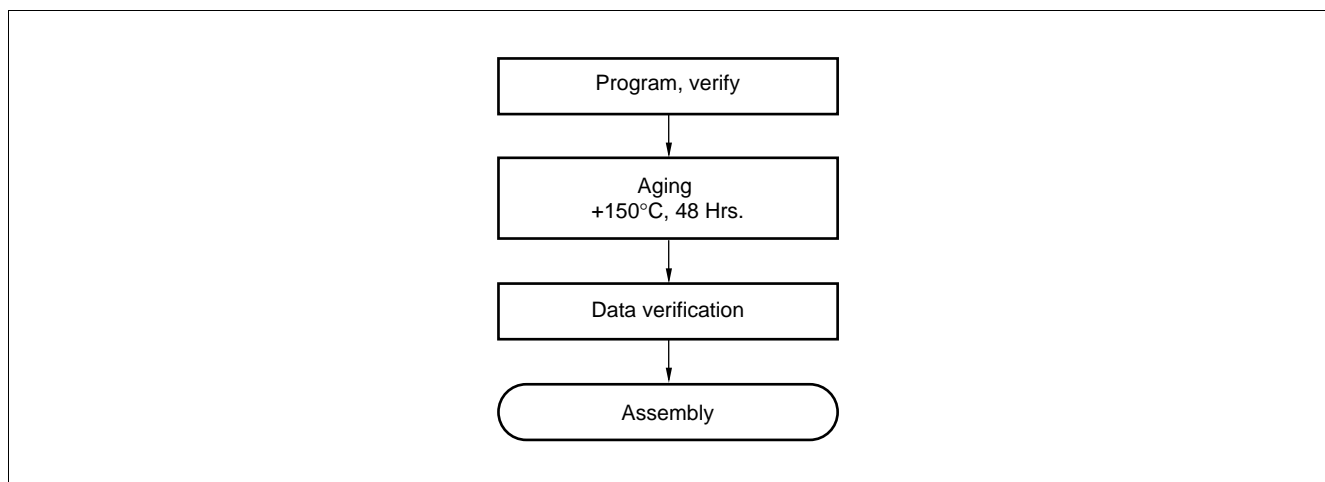

5. Programming Yield

All bits cannot be programmed at Fujitsu shipping test to a blanked OTPROM microcomputer, due to its nature. For this reason, a programming yield of 100% cannot be assured at all times.

6. EPROM Programmer Socket Adapter

Package	Compatible socket adapter
FPT-80P-M05	ROM-80SQF-28DP-8L
FPT-80P-M06	ROM-80QF-28DP-8L3
FPT-80P-M11	ROM-80QF2-28DP-8L2

Inquiry: Sun Hayato Co., Ltd.: TEL 81-3-3802-5760

7. Setting OTPROM Options

The programming procedure is the same as that for the PROM. Options can be set by programming values at the addresses shown on the memory map. The relationship between bits and options is shown on the following bit map:

- **OTPROM option bit map**

	Bit 7	Bit 6	Bit 5	Bit 4	Bit 3	Bit 2	Bit 1	Bit 0
3FF0 _H	Vacancy Readable	Vacancy Readable	Oscillation stabilization time WTM1 WTM0 See section "■ Mask Options."		Vacancy Readable	Reset pin output 1: Yes 0: No	Clock mode selection 1: Dual clock 0: Single clock	Power-on reset 1: Yes 0: No
3FF1 _H	P07 Pull-up 1: No 0: Yes	P06 Pull-up 1: No 0: Yes	P05 Pull-up 1: No 0: Yes	P04 Pull-up 1: No 0: Yes	P03 Pull-up 1: No 0: Yes	P02 Pull-up 1: No 0: Yes	P01 Pull-up 1: No 0: Yes	P00 Pull-up 1: No 0: Yes
3FF2 _H	P17 Pull-up 1: No 0: Yes	P16 Pull-up 1: No 0: Yes	P15 Pull-up 1: No 0: Yes	P14 Pull-up 1: No 0: Yes	P13 Pull-up 1: No 0: Yes	P12 Pull-up 1: No 0: Yes	P11 Pull-up 1: No 0: Yes	P10 Pull-up 1: No 0: Yes
3FF3 _H	Vacancy Readable	Vacancy Readable	Vacancy Readable	Vacancy Readable	Vacancy Readable	Vacancy Readable	Vacancy Readable	Vacancy Readable
3FF4 _H	Vacancy Readable	Vacancy Readable	Vacancy Readable	Vacancy Readable	Vacancy Readable	Vacancy Readable	Vacancy Readable	Vacancy Readable
3FF5 _H	Vacancy Readable	Vacancy Readable	Vacancy Readable	Vacancy Readable	Vacancy Readable	Vacancy Readable	Vacancy Readable	Vacancy Readable

- Notes:
- Set each bit to 1 to erase.
 - Do not write 0 to the vacant bit.
The read value of the vacant bit is 1, unless 0 is written to it.

MB89150/150A Series

■ PROGRAMMING TO THE EPROM WITH PIGGYBACK/EVALUATION DEVICE

1. EPROM for Use

MBM27C256A-20TV

2. Programming Socket Adapter

To program to the PROM using an EPROM programmer, use the socket adapter (manufacturer: Sun Hayato Co., Ltd.) listed below.

Package	Adapter socket part number
LCC-32(Rectangle)	ROM-32LC-28DP-YG
LCC-32(Square)	ROM-32LC-28DP-S

Inquiry: Sun Hayato Co., Ltd.: TEL 81-3-3802-5760

3. Memory Space

Memory space in each mode is diagrammed below.

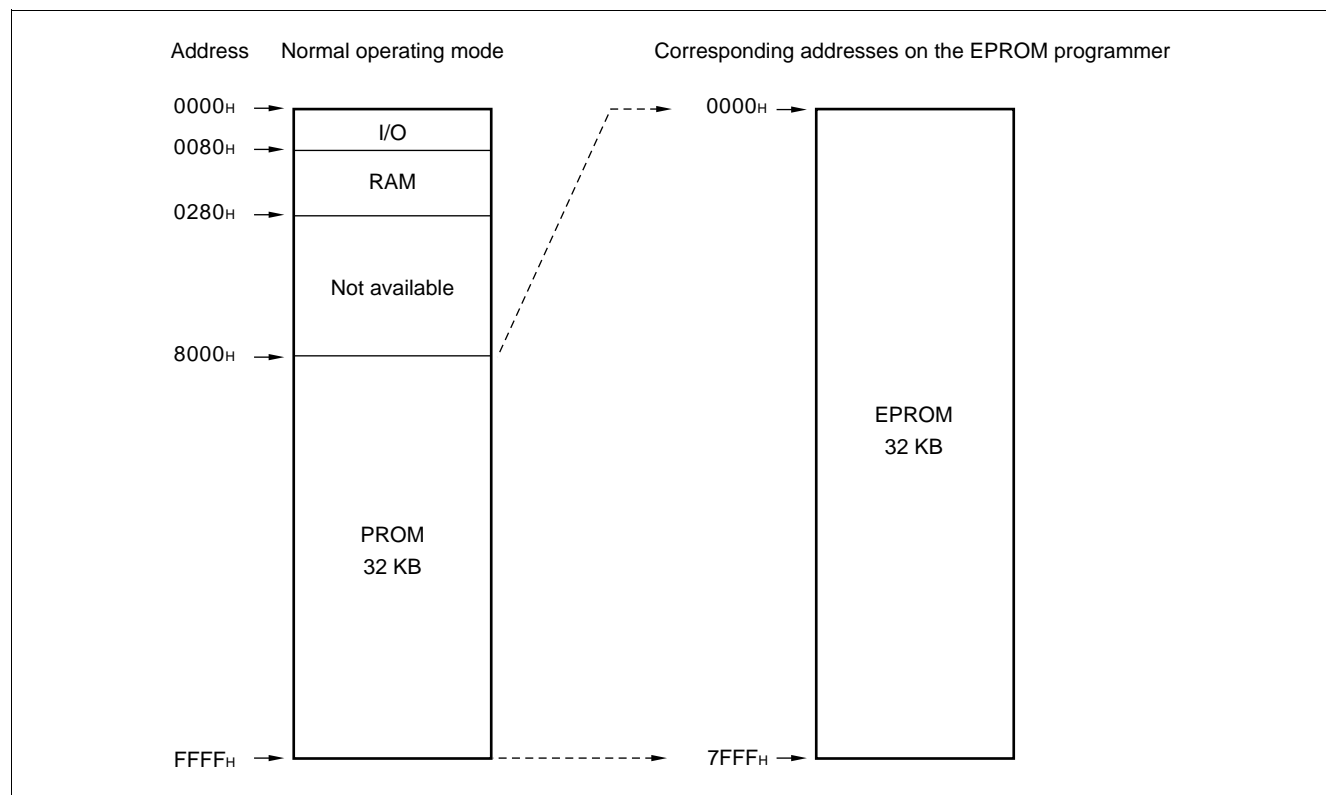

4. Programming to the EPROM

- (1) Set the EPROM programmer to the MBM27C256A.
- (2) Load program data into the EPROM programmer at 4000H to 7FFFH.
- (3) Program to 0000H to 7FFFH with the EPROM programmer.

■ BLOCK DIAGRAM

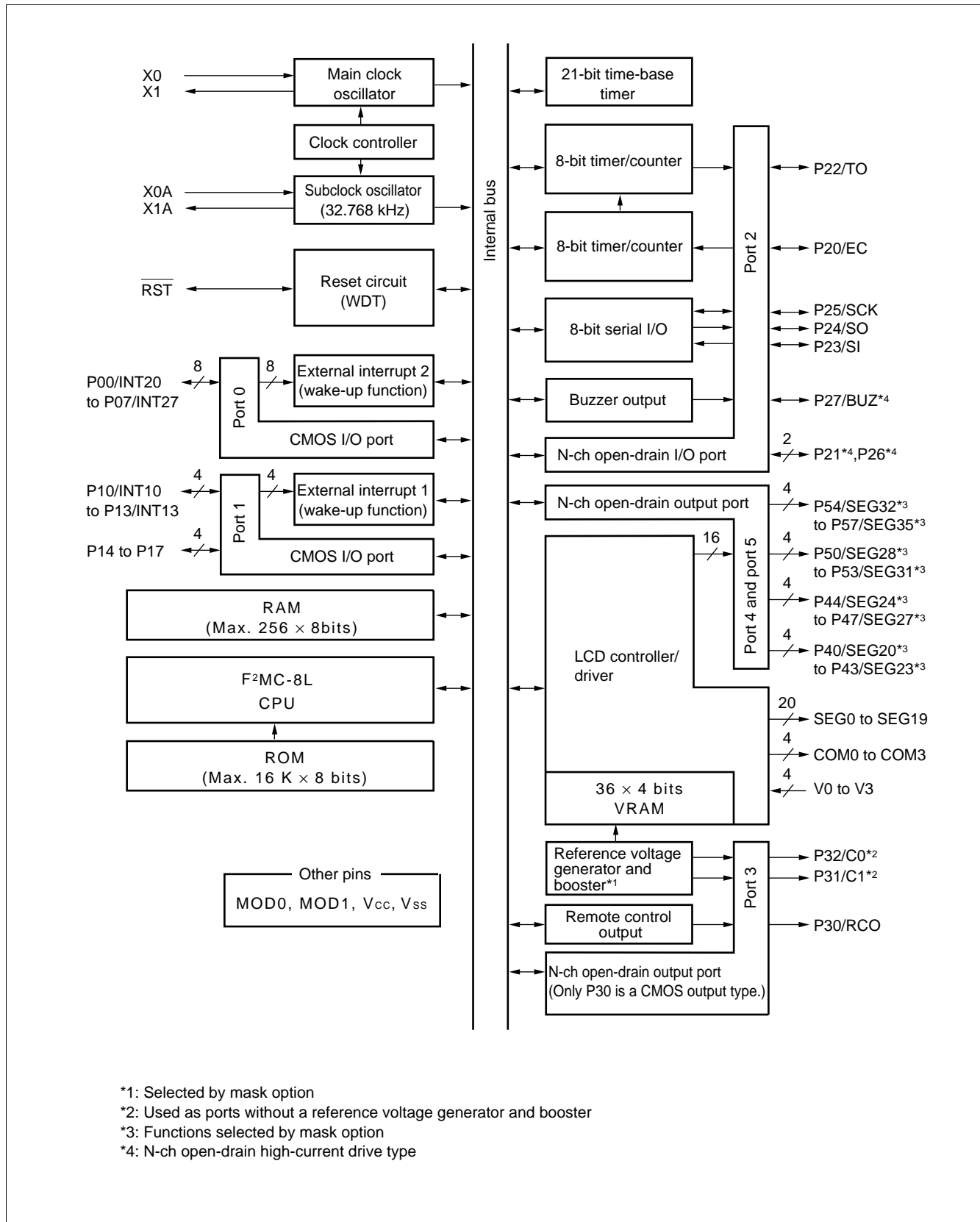

*1: Selected by mask option

*2: Used as ports without a reference voltage generator and booster

*3: Functions selected by mask option

*4: N-ch open-drain high-current drive type

MB89150/150A Series

■ CPU CORE

1. Memory Space

The microcontrollers of the MB89150/A series offer a memory space of 64 Kbytes for storing all of I/O, data, and program areas. The I/O area is located at the lowest address. The data area is provided immediately above the I/O area. The data area can be divided into register, stack, and direct areas according to the application. The program area is located at exactly the opposite end, that is, near the highest address. Provide the tables of interrupt reset vectors and vector call instructions toward the highest address within the program area. The memory space of the MB89150/A series is structured as illustrated below.

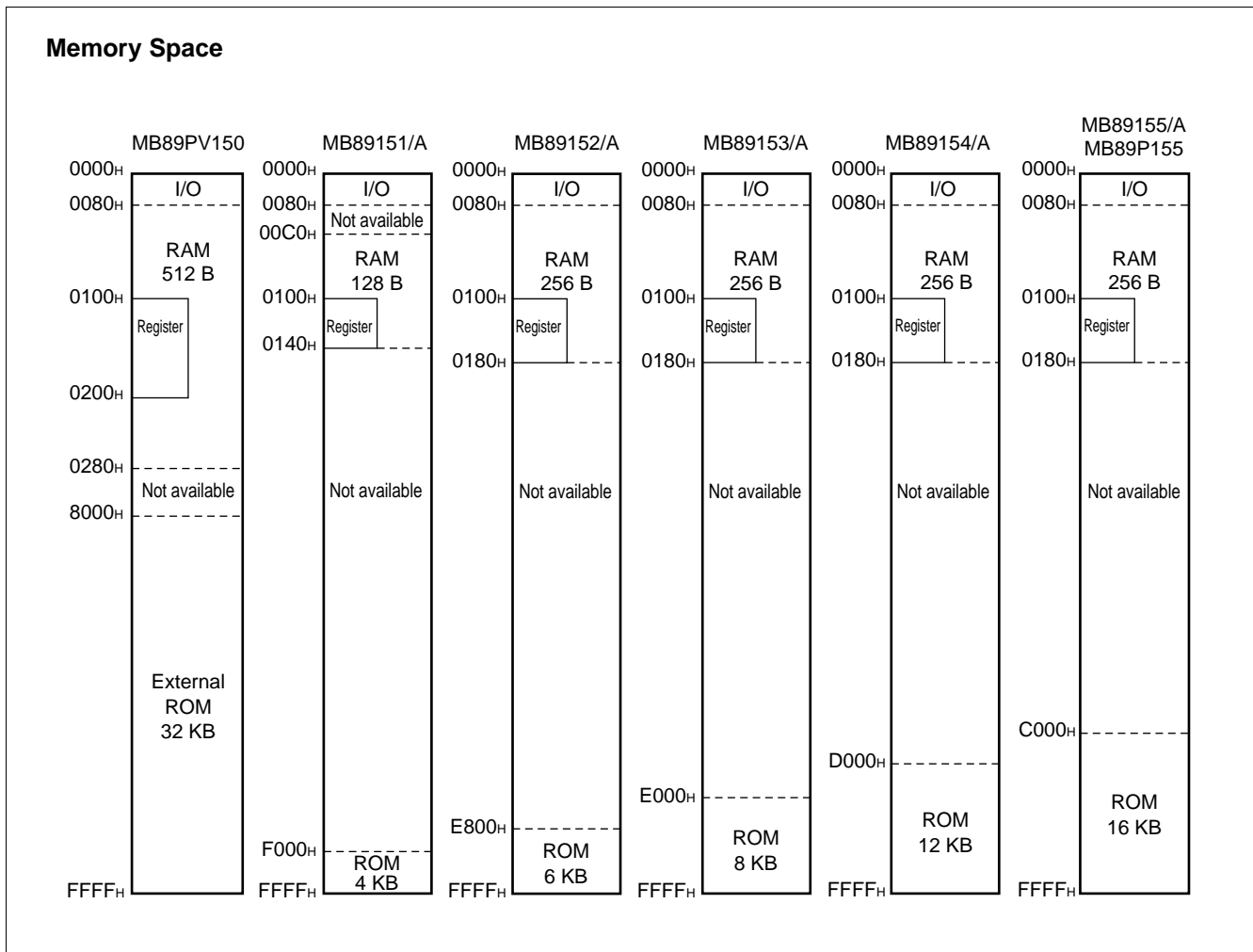

2. Registers

The F²MC-8L family has two types of registers; dedicated registers in the CPU and general-purpose registers in the memory. The following dedicated registers are provided:

- Program counter (PC): A 16-bit register for indicating instruction storage positions
- Accumulator (A): A 16-bit temporary register for storing arithmetic operations, etc. When the instruction is an 8-bit data processing instruction, the lower byte is used.
- Temporary accumulator (T): A 16-bit register which performs arithmetic operations with the accumulator. When the instruction is an 8-bit data processing instruction, the lower byte is used.
- Index register (IX): A 16-bit register for index modification
- Extra pointer (EP): A 16-bit pointer for indicating a memory address
- Stack pointer (SP): A 16-bit register for indicating a stack area
- Program status (PS): A 16-bit register for storing a register pointer, a condition code

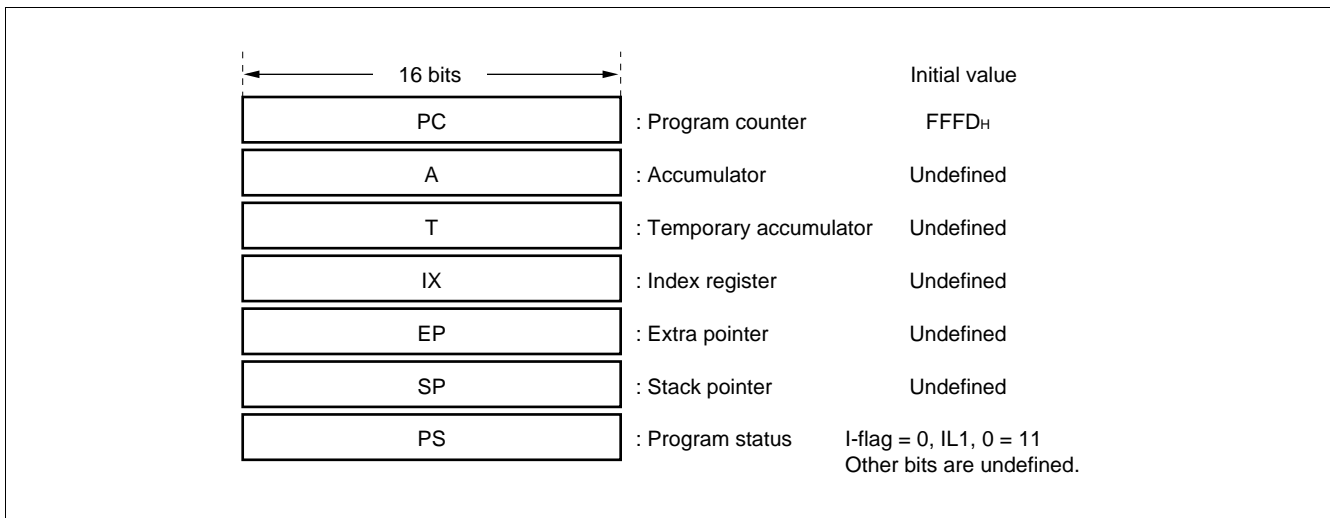

The PS can further be divided into higher 8 bits for use as a register bank pointer (RP) and the lower 8 bits for use as a condition code register (CCR). (See the diagram below.)

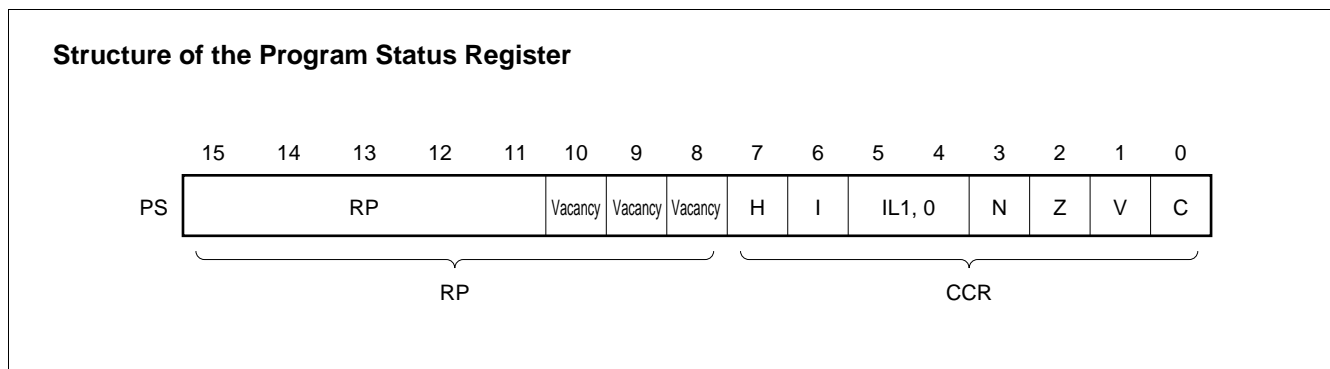

MB89150/150A Series

The RP indicates the address of the register bank currently in use. The relationship between the pointer contents and the actual address is based on the conversion rule illustrated below.

Rule for Conversion of Actual Addresses of the General-purpose Register Area

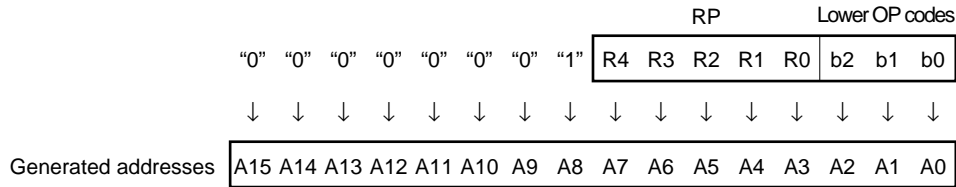

The CCR consists of bits indicating the results of arithmetic operations and the contents of transfer data and bits for control of CPU operations at the time of an interrupt.

- H-flag: Set when a carry or a borrow from bit 3 to bit 4 occurs as a result of an arithmetic operation. Cleared otherwise. This flag is for decimal adjustment instructions.
- I-flag: Interrupt is allowed when this flag is set to 1. Interrupt is prohibited when the flag is set to 0. Set to 0 when reset.
- IL1, 0: Indicates the level of the interrupt currently allowed. Processes an interrupt only if its request level is higher than the value indicated by this bit.

IL1	ILO	Interrupt level	High-low
0	0	1	High ↑ ↓ Low = no interrupt
0	1		
1	0	2	
1	1	3	

- N-flag: Set if the MSB is set to 1 as the result of an arithmetic operation. Cleared when the bit is set to 0.
- Z-flag: Set when an arithmetic operation results in 0. Cleared otherwise.
- V-flag: Set if the complement on 2 overflows as a result of an arithmetic operation. Reset if the overflow does not occur.
- C-flag: Set when a carry or a borrow from bit 7 occurs as a result of an arithmetic operation. Cleared otherwise. Set to the shift-out value in the case of a shift instruction.

The following general-purpose registers are provided:

General-purpose registers: An 8-bit register for storing data

The general-purpose registers are 8 bits and located in the register banks of the memory. One bank contains eight registers. Up to a total of 8 banks can be used on the MB89151 (RAM 128×8 bits), and a total of 16 banks can be used on the MB89152/3/4/5 (RAM 256×8 bits). The bank currently in use is indicated by the register bank pointer (RP).

Note: The number of register banks that can be used varies with the RAM size.

Register Bank Configuration

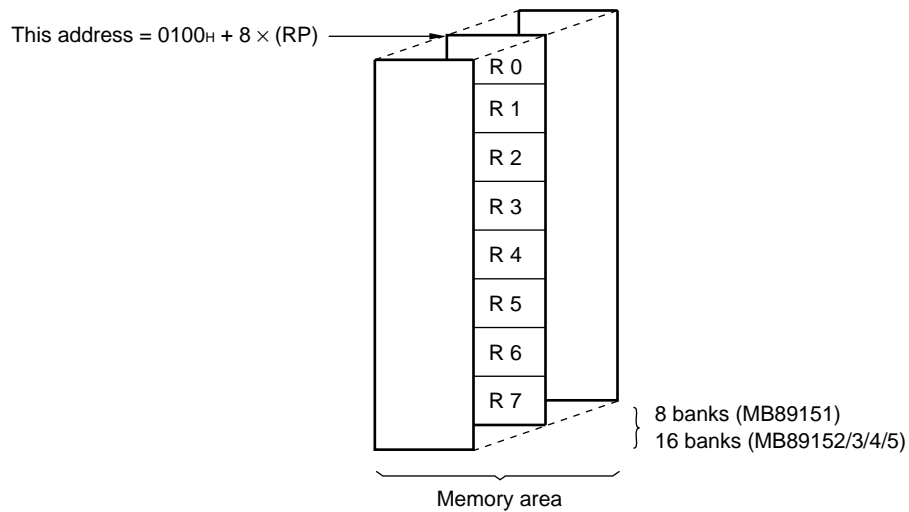

MB89150/150A Series

■ I/O MAP

Address	Read/write	Register name	Register description
00 _H	(R/W)	PDR0	Port 0 data register
01 _H	(W)	DDR0	Port 0 data direction register
02 _H	(R/W)	PDR1	Port 1 data register
03 _H	(W)	DDR1	Port 1 data direction register
04 _H	(R/W)	PDR2	Port 2 data register
05 _H	(W)	DDR2	Port 2 data direction register
06 _H			Vacancy
07 _H	(R/W)	SYCC	System clock control register
08 _H	(R/W)	STBC	Standby control register
09 _H	(R/W)	WDTC	Watchdog timer control register
0A _H	(R/W)	TBTC	Time-base timer control register
0B _H	(R/W)	WPCR	Watch prescaler control register
0C _H	(R/W)	PDR3	Port 3 data register
0D _H			Vacancy
0E _H	(R/W)	PDR4	Port 4 data register
0F _H	(R/W)	PDR5	Port 5 data register
10 _H	(R/W)	BZCR	Buzzer register
11 _H			Vacancy
12 _H			Vacancy
13 _H			Vacancy
14 _H	(R/W)	RCR1	Remote control transmission register 1
15 _H	(R/W)	RCR2	Remote control transmission register 2
16 _H			Vacancy
17 _H			Vacancy
18 _H	(R/W)	T2CR	Timer 2 control register
19 _H	(R/W)	T1CR	Timer 1 control register
1A _H	(R/W)	T2DR	Timer 2 data register
1B _H	(R/W)	T1DR	Timer 1 data register
1C _H	(R/W)	SMR1	Serial mode register
1D _H	(R/W)	SDR1	Serial data register
1E _H to 2F _H			Vacancy

(Continued)

MB89150/150A Series

(Continued)

Address	Read/write	Register name	Register description
30 _H	(R/W)	EIE1	External interrupt 1 enable register
31 _H	(R/W)	EIF1	External interrupt 1 flag register
32 _H	(R/W)	EIE2	External interrupt 2 enable register
33 _H	(R/W)	EIF2	External interrupt 2 flag register
34 _H to 5F _H			Vacancy
60 _H to 71 _H	(R/W)	VRAM	Display data RAM
72 _H	(R/W)	LCR1	LCD controller/driver control register 1
73 _H to 7B _H			Vacancy
7C _H	(W)	ILR1	Interrupt level setting register 1
7D _H	(W)	ILR2	Interrupt level setting register 2
7E _H	(W)	ILR3	Interrupt level setting register 3
7F _H			Vacancy

Note: Do not use vacancies.

MB89150/150A Series

■ ELECTRICAL CHARACTERISTICS

1. Absolute Maximum Ratings

($V_{SS} = 0.0\text{ V}$)

Parameter	Symbol	Value		Unit	Remarks
		Min.	Max.		
Power supply voltage	V_{CC}	$V_{SS} - 0.3$	$V_{SS} + 7.0$	V	
LCD power supply voltage	V0 to V3	$V_{SS} - 0.3$	$V_{SS} + 7.0$	V	V0 to V3 pins on the product with booster
		$V_{SS} - 0.3$	$V_{CC} + 0.3$	V	V0 to V3 pins on the product without booster
Input voltage	V_{I1}	$V_{SS} - 0.3$	$V_{CC} + 0.3$	V	V_{I1} must not exceed $V_{SS} + 7.0\text{ V}$. All pins except P20 to P27 without a pull-up resistor
	V_{I2}	$V_{SS} - 0.3$	$V_{SS} + 7.0$	V	P20 to P27 without a pull-up resistor
Output voltage	V_{O1}	$V_{SS} - 0.3$	$V_{CC} + 0.3$	V	V_{O1} must not exceed $V_{SS} + 7.0\text{ V}$. All pins except P20 to P27, P31, P32, P40 to P47, P50 to P57 without a pull-up resistor
	V_{O2}	$V_{SS} - 0.3$	$V_{SS} + 7.0$	V	P20 to P27, P31, P32, P40 to P47, and P50 to P57, without a pull-up resistor
“L” level maximum output current	I_{OL1}	—	10	mA	All pins except P21, P26, P27, and power supply pins
	I_{OL2}	—	20	mA	P21, P26, and P27
“L” level average output current	I_{OLAV1}	—	4	mA	Average value (operating current \times operating rate) All pins except P21, P26, P27, and power supply pins.
	I_{OLAV2}	—	8	mA	Average value (operating current \times operating rate) P21, P26, and P27
“L” level total maximum output current	ΣI_{OL}	—	80	mA	
“L” level total average output current	ΣI_{OLAV}	—	40	mA	Average value (operating current \times operating rate)
“H” level maximum output current	I_{OH1}	—	-5	mA	All pins except P30 and power supply pins
	I_{OH2}	—	-10	mA	P30

(Continued)

MB89150/150A Series

(Continued)

(V_{SS} = 0.0 V)

Parameter	Symbol	Value		Unit	Remarks
		Min.	Max.		
“H” level average output current	I _{OHAV1}	—	−2	mA	Average value (operating current × operating rate) All pins except P30 and power supply pins.
	I _{OHAV2}	—	−4	mA	Average value (operating current × operating rate) P30
“H” level total output current	ΣI _{OH}	—	−20	mA	
“H” level total average output current	ΣI _{OHAV}	—	−10	mA	Average value (operating current × operating rate)
Power consumption	P _D	—	300	mW	
Operating temperature	T _A	−40	+85	°C	
Storage temperature	T _{stg}	−55	+150	°C	

Precautions: Permanent device damage may occur if the above “Absolute Maximum Ratings” are exceeded. Functional operation should be restricted to the conditions as detailed in the operational sections of this data sheet. Exposure to absolute maximum rating conditions for extended periods may affect device reliability.

2. Recommended Operating Conditions

(V_{SS} = 0.0 V)

Parameter	Symbol	Value		Unit	Remarks
		Min.	Max.		
Power supply voltage	V _{CC}	2.2 ^{*1}	6.0	V	Normal operation assurance range Single clock system of the mask ROM product.
		2.2 ^{*1}	4.0	V	Normal operation assurance range Dual-clock system of the mask ROM product.
		2.7 ^{*1}	6.0	V	MB89P155/PV150
		1.5	6.0	V	Retains the RAM state in stop mode
LCD power supply voltage	V ₀ to V ₃	V _{SS}	V _{CC} ^{*2}	V	V ₀ to V ₃ pins
LCD reference power supply input voltage	V _{IR}	1.3	2.2	V	V ₁ pin on the products with a booster Reference power external input
Operating temperature	T _A	−40	+85	°C	

*1: The minimum operating power supply voltage varies with the execution time (instruction cycle time) setting for the operating frequency.

*2: The LCD power supply voltage range and optimum value vary depending on the characteristics of the liquid-crystal display element.

MB89150/150A Series

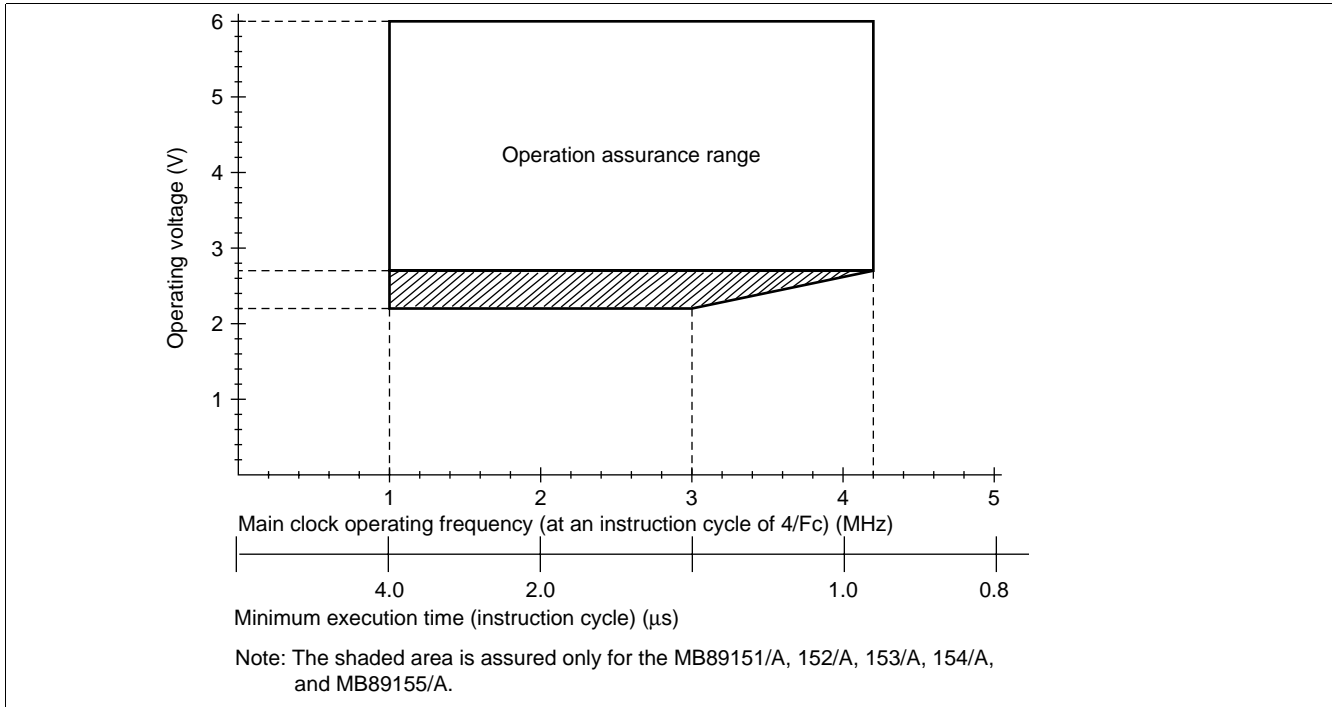

Figure 1 Operating Voltage vs. Main Clock Operating Frequency (MB89P155/PV150, and single-clock MB89151/A, 152/A, 153/A, 154/A, and MB89155/A)

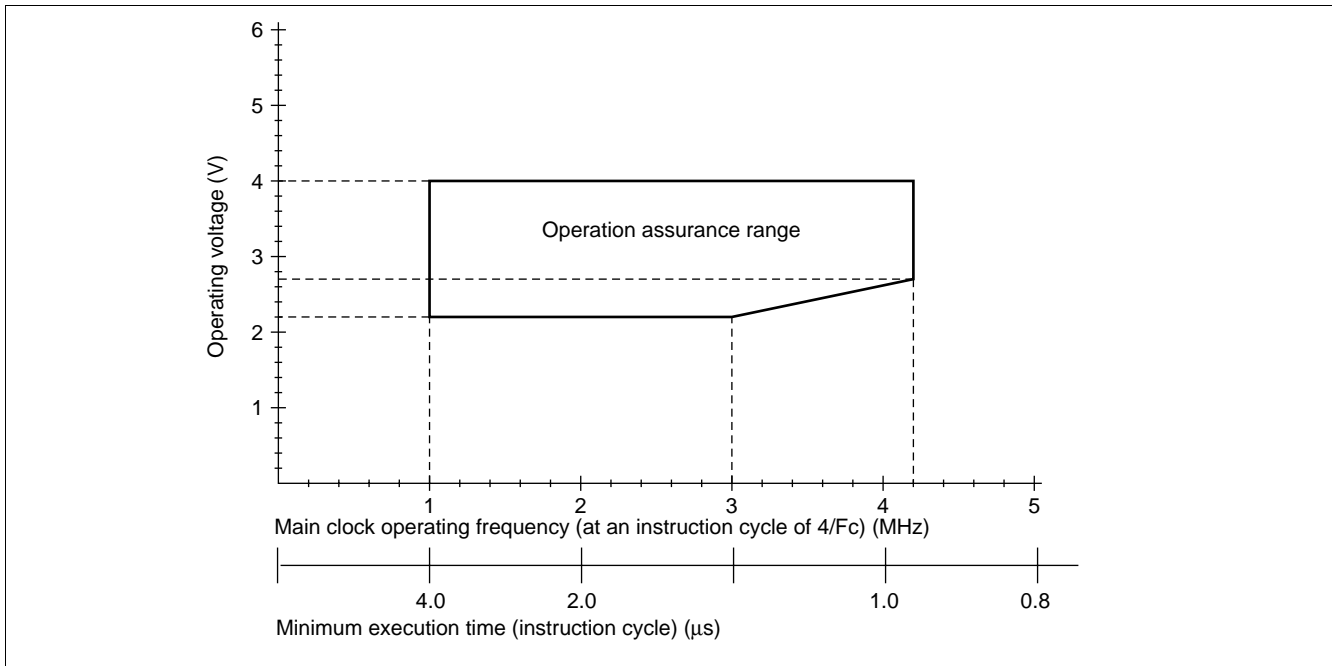

Figure 2 Operating Voltage vs. Main Clock Operating Frequency (Dual-clock MB89151/A, 152/A, 153/A, 154/A, and MB89155/A)

Figures 1 and 2 indicate the operating frequency of the external oscillator at a minimum execution time of $4/F_{CH}$. Since the operating voltage range is dependent on the minimum execution time, see the minimum execution time if the operating speed is switched using a gear.

MB89150/150A Series

3. DC Characteristics

($V_{CC} = +5.0\text{ V}$, $V_{SS} = 0.0\text{ V}$, $T_A = -40^\circ\text{C}$ to $+85^\circ\text{C}$)

Parameter	Symbol	Pin	Condition	Value			Unit	Remarks
				Min.	Typ.	Max.		
“H” level input voltage	V_{IH}	P00 to P07, P10 to P17, P20 to P27	—	$0.7 V_{CC}$	—	$V_{CC} + 0.3$	V	CMOS input
	V_{IHS}	RST, MOD0, MOD1, EC, SI, SCK, INT10 to INT13, INT20 to INT27		$0.8 V_{CC}$	—	$V_{SS} + 0.3$	V	Hysteresis input
“L” level input voltage	V_{IL}	P00 to P07, P10 to P17, P20 to P27	—	$V_{SS} - 0.3$	—	$0.3 V_{CC}$	V	CMOS input
	V_{ILS}	RST, MOD0, MOD1, EC, SI, SCK, INT10 to INT13, INT20 to INT27		$V_{SS} - 0.3$	—	$0.2 V_{CC}$	V	Hysteresis input
Open-drain output pin application voltage	V_D	P20 to P27, P31, P32, P40 to P47, P50 to P57	—	$V_{SS} - 0.3$	—	$V_{SS} + 6.0^1$	V	Without pull-up resistor
“H” level output voltage	V_{OH1}	P00 to P07, P10 to P17	$I_{OH} = -2.0\text{ mA}$	2.4	—	—	V	
	V_{OH2}	P30	$I_{OH} = -6.0\text{ mA}$	4.0	—	—	V	
“L” level output voltage	V_{OL1}	P00 to P07, P10 to P17, P20, P22 to P25, P30 to P32, P40 to P47, P50 to P57	$I_{OL} = 1.8\text{ mA}$	—	—	0.4	V	
	V_{OL2}	P21, P26, P27	$I_{OL} = 8.0\text{ mA}$	—	—	0.4	V	
	V_{OL3}	RST	$I_{OL} = 4.0\text{ mA}$	—	—	0.4	V	
Input leakage current (Hi-z output leakage current)	I_{LI1}	MOD0, MOD1, P30, P00 to P07, P10 to P17	$0.0\text{ V} < V_i < V_{CC}$	—	—	± 5	μA	Without pull-up resistor
	I_{LI2}	P20 to P27, P31, P32, P40 to P47, P50 to P57	$0.0\text{ V} < V_i < 6.0\text{ V}$	—	—	± 1	μA	Without pull-up resistor
Pull-up resistance	R_{PULL}	P00 to P07, P10 to P17, P20 to P27, P40 to P47, P50 to P57, RST	$V_i = 0.0\text{ V}$	25	50	100	$k\Omega$	With pull-up resistor
Common output impedance	R_{VCOM}	COM0 to COM3	V_1 to $V_3 = 5.0\text{ V}$	—	—	2.5	$k\Omega$	
Segment output impedance	R_{VSEG}	SEG0 to SEG35	V_1 to $V_3 = 5.0\text{ V}$	—	—	15	$k\Omega$	
LCD divided resistance	R_{LCD}	—	Between V_{CC} and V_0	300	500	750	$k\Omega$	Products without a booster only
LCD leakage current	I_{LCDL}	V_0 to V_3 , COM0 to COM3, SEG0 to SEG35	—	—	—	± 1	μA	

(Continued)

MB89150/150A Series

($V_{CC} = +5.0\text{ V}$, $V_{SS} = 0.0\text{ V}$, $T_A = -40^\circ\text{C}$ to $+85^\circ\text{C}$)

Parameter	Symbol	Pin	Condition	Value			Unit	Remarks
				Min.	Typ.	Max.		
Booster for LCD driving output voltage	V_{OV3}	V3	$V1 = 1.5\text{ V}$	4.3	4.5	4.7	V	Products with a booster only
	V_{OV2}	V2		2.9	3.0	3.1	V	
Reference output voltage for LCD driving	V_{OV1}	V1	$I_{IN} = 0\ \mu\text{A}$	1.3	1.5	1.7	V	
Power supply current ²	I_{CC1}	V_{CC}	$F_{CH} = 4.2\text{ MHz}$, $V_{CC} = 5.0\text{ V}$ $t_{inst}^{*3} = 0.95\ \mu\text{s}$ Main clock operation	—	3.0	4.5	mA	MB89151/A, 152/A, 153/A, 154/A, 155/A, MB89PV150-101 to 105
				—	3.8	6.0	mA	MB89P155-101 to 105/201 to 205
	I_{CC2}		$F_{CH} = 4.2\text{ MHz}$, $V_{CC} = 3.0\text{ V}$ $t_{inst}^{*3} = 15.2\ \mu\text{s}$ Main clock operation	—	0.25	0.4	mA	MB89151/A, 152/A, 153/A, 154/A, 155/A, MB89PV150-101 to 105
				—	0.85	1.4	mA	MB89P155-101 to 105/201 to 205
	I_{CCL}		$F_{CL} = 32.768\text{ kHz}$, $V_{CC} = 3.0\text{ V}$ $t_{inst}^{*3} = 61\ \mu\text{s}$ Subclock operation	—	0.05	0.1	mA	MB89151/A, 152/A, 153/A, 154/A, 155/A, MB89PV150-101 to 105
				—	0.65	1.1	mA	MB89P155-101 to 105/201 to 205
	I_{CCS1}		$F_{CH} = 4.2\text{ MHz}$, $V_{CC} = 5.0\text{ V}$ $t_{inst}^{*3} = 0.95\ \mu\text{s}$ Main clock sleep mode	—	0.8	1.2	mA	
	I_{CCS2}		$F_{CH} = 4.2\text{ MHz}$, $V_{CC} = 3.0\text{ V}$ $t_{inst}^{*3} = 15.2\ \mu\text{s}$ Main clock sleep mode	—	0.2	0.3	mA	
	I_{CCSL}		$F_{CL} = 32.768\text{ kHz}$, $V_{CC} = 3.0\text{ V}$ $t_{inst}^{*3} = 61\ \mu\text{s}$ Subclock sleep mode	—	25	50	μA	

(Continued)

MB89150/150A Series

(Continued)

($V_{CC} = +5.0\text{ V}$, $V_{SS} = 0.0\text{ V}$, $T_A = -40^\circ\text{C}$ to $+85^\circ\text{C}$)

Parameter	Symbol	Pin	Condition	Value			Unit	Remarks
				Min.	Typ.	Max.		
Power supply current ²	I _{CC1}	V _{CC}	F _{CL} = 32.768 kHz, V _{CC} = 3.0 V Watch mode	—	10	15	μA	MB89151/2/3/4/5, MB89P155-101 to 105, MB89PV150-101 to 105
	I _{CC2}		F _{CL} = 32.768 kHz, V _{CC} = 3.0 V • Watch mode • During reference voltage generator and booster operation	—	250	400	μA	MB89151A/2A/ 3A/4A/5A, MB89P155-201 to 205
	I _{CC3}		T _A = +25°C, V _{CC} = 5.0 V Stop mode	—	0.1	1	μA	MB89151/2/3/4/5
Input capacitance	C _{IN}	Other than V _{CC} , V _{SS}	f = 1 MHz	—	10	—	pF	

*1: P31 and P32 are applicable only for products of the MB89150 series (without the "A" suffix). P40 to P47 and P50 to P57 are applicable when selected as ports.

*2: The power supply current is measured at the external clock, open output pins, and the external LCD dividing resistor (or external input for the reference voltage).

In the case of the MB89PV150, the current consumed by the connected EPROM and ICE is not included.

*3: For information on t_{inst}, see "(4) Instruction Cycle" in "4. AC Characteristics."

Note: For pins which serves as the segment (SEG20 to SEG35) and ports (P40 to P47, P50 to P57), see the port parameter when these pins are used as ports and the segment parameter when they are used as segments. P31 and P32 are applicable only for products without a booster (applicable as external capacitor connection pins for products with a booster).

MB89150/150A Series

4. AC Characteristics

(1) Reset Timing

($V_{SS} = 0.0\text{ V}$, $T_A = -40^\circ\text{C}$ to $+85^\circ\text{C}$)

Parameter	Symbol	Condition	Value		Unit	Remarks
			Min.	Max.		
RST "L" pulse width	t_{ZLZH}	—	48 t_{HCYL}	—	ns	

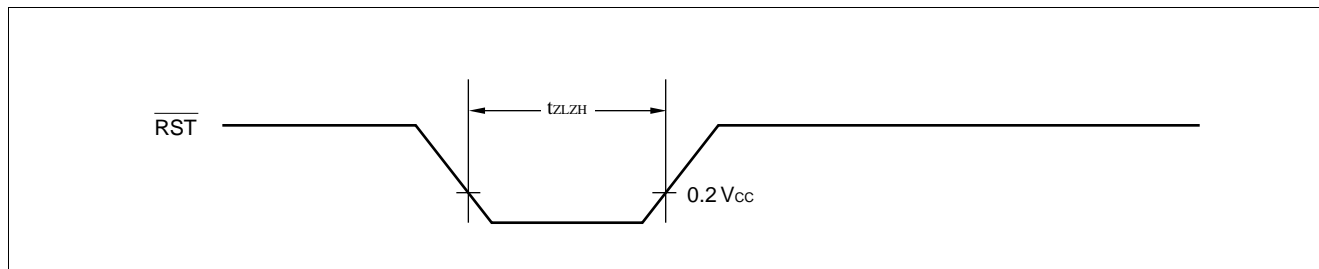

(2) Power-on Reset

($V_{SS} = 0.0\text{ V}$, $T_A = -40^\circ\text{C}$ to $+85^\circ\text{C}$)

Parameter	Symbol	Condition	Value		Unit	Remarks
			Min.	Max.		
Power supply rising time	t_R	—	—	50	ms	Power-on reset function only
Power supply cut-off time	t_{OFF}		1	—	ms	Due to repeated operations

Note: Make sure that power supply rises within the selected oscillation stabilization time.
If power supply voltage needs to be varied in the course of operation, a smooth voltage rise is recommended.

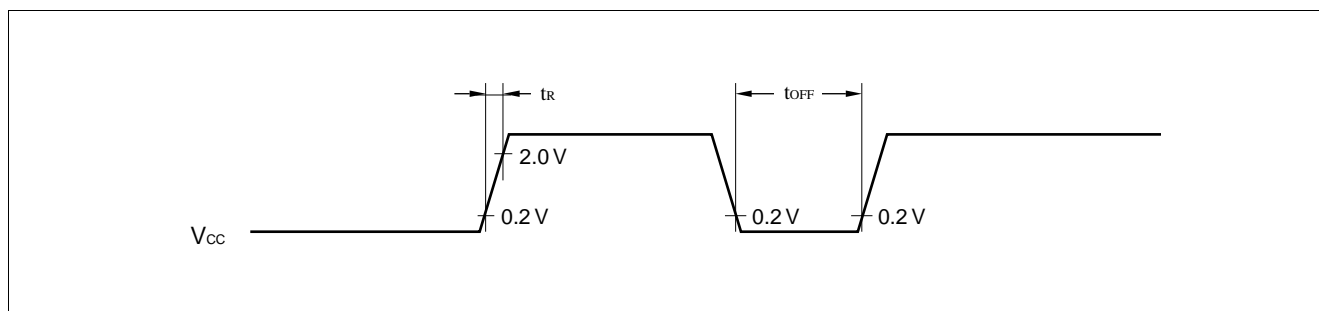

(3) Clock Timing

($V_{SS} = 0.0\text{ V}$, $T_A = -40^\circ\text{C}$ to $+85^\circ\text{C}$)

Parameter	Symbol	Pin	Value			Unit	Remarks
			Min.	Typ.	Max.		
Clock frequency	F_{CH}	X0, X1	1	—	4.2	MHz	Main clock
	F_{CL}	X0A, X1A	—	32.768	—	kHz	Subclock
Clock cycle time	t_{HCYL}	X0, X1	238	—	1000	ns	Main clock
	t_{LCYL}	X0A, X1A	—	30.5	—	μs	Subclock
Input clock pulse width	P_{WH} P_{WL}	X0	20	—	—	ns	External clock
	P_{WHL} P_{WLL}	X0A	—	15.2	—	μs	
Input clock pulse rising/falling time	t_{CR} t_{CF}	X0, X0A	—	—	10	ns	

X0 and X1 Timing and Conditions

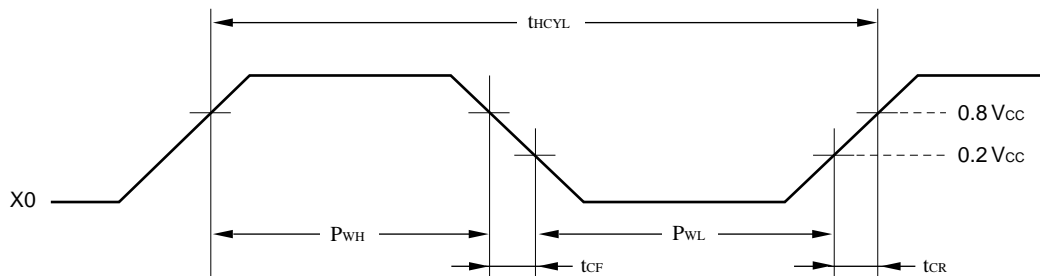

Main Clock Conditions

When a crystal or ceramic resonator is used

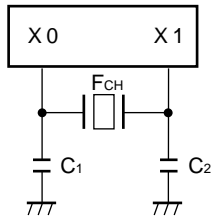

When an external clock is used

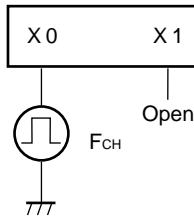

When the CR oscillation option is used

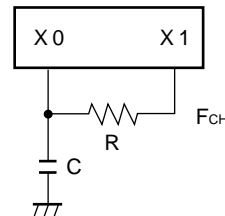

MB89150/150A Series

X0A and X1A Timing and Conditions

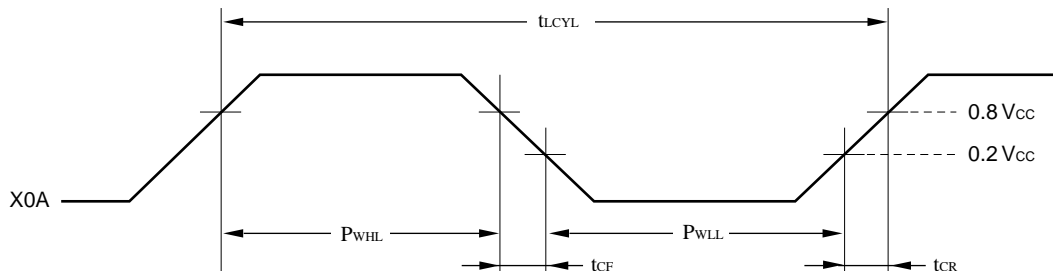

Subclock Conditions

When a crystal or ceramic resonator is used

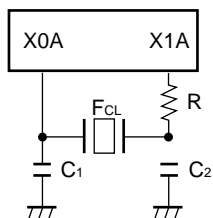

When an external clock is used

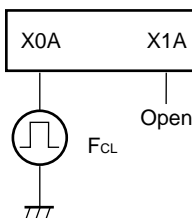

When the single clock option is used

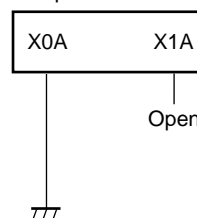

(4) Instruction Cycle

Parameter	Symbol	Value	Unit	Remarks
Instruction cycle (minimum execution time)	t_{inst}	$4/F_{CH}$, $8/F_{CH}$, $16/F_{CH}$, $64/F_{CH}$	μS	$(4/F_{CH}) t_{inst} = 0.95 \mu s$ when operating at $F_{CH} = 4.2 \text{ MHz}$
		$2/F_{CL}$	μS	$t_{inst} = 61.036 \mu s$ when operating at $F_{CL} = 32.768 \text{ kHz}$

(5) Serial I/O Timing

($V_{CC} = +5.0 V \pm 10\%$, $V_{SS} = 0.0 V$, $T_A = -40^\circ C$ to $+85^\circ C$)

Parameter	Symbol	Pin	Condition	Value		Unit	Remarks
				Min.	Max.		
Serial clock cycle time	t_{SCYC}	SCK	Internal shift clock mode	$2 t_{inst}^*$	—	μs	
SCK $\downarrow \rightarrow$ SO time	t_{SLOV}	SCK, SO		-200	200	ns	
Valid SI \rightarrow SCK \uparrow	t_{IVSH}	SI, SCK		$0.5 t_{inst}^*$	—	μs	
SCK $\uparrow \rightarrow$ valid SI hold time	t_{SHIX}	SCK, SI		$0.5 t_{inst}^*$	—	μs	
Serial clock "H" pulse width	t_{SHSL}	SCK	External shift clock mode	$1 t_{inst}^*$	—	μs	
Serial clock "L" pulse width	t_{LSLH}	SCK		$1 t_{inst}^*$	—	μs	
SCK $\downarrow \rightarrow$ SO time	t_{SLOV}	SCK, SO		0	200	ns	
Valid SI \rightarrow SCK \uparrow	t_{IVSH}	SI, SCK		$0.5 t_{inst}^*$	—	μs	
SCK $\uparrow \rightarrow$ valid SI hold time	t_{SHIX}	SCK, SI		$0.5 t_{inst}^*$	—	μs	

* : For information on t_{inst} , see "(4) Instruction Cycle."

Internal Shift Clock Mode

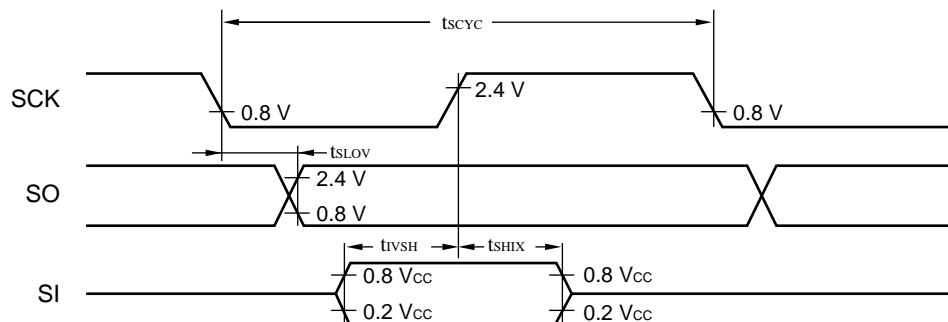

External Shift Clock Mode

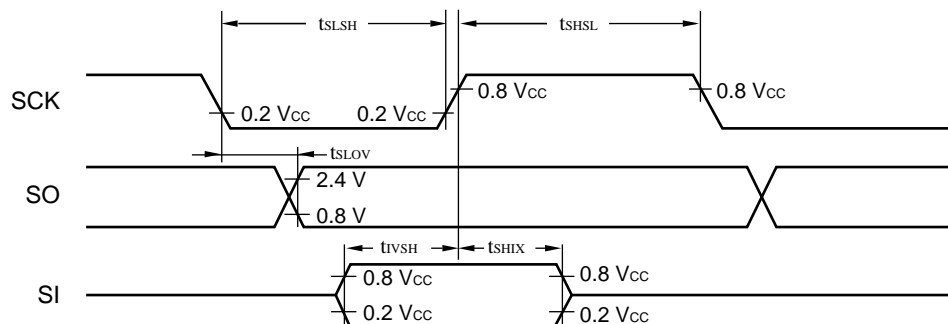

MB89150/150A Series

(6) Peripheral Input Timing

($V_{CC} = +5.0\text{ V} \pm 10\%$, $V_{SS} = 0.0\text{ V}$, $T_A = -40^\circ\text{C}$ to $+85^\circ\text{C}$)

Parameter	Symbol	Pin	Value		Unit	Remarks
			Min.	Max.		
Peripheral input "H" pulse width 1	t_{L1H1}	INT10 to INT13, EC	1 t_{inst}^*	—	μs	
Peripheral input "L" pulse width 1	t_{H1L1}		1 t_{inst}^*	—	μs	
Peripheral input "H" pulse width 2	t_{L2H2}	INT20 to INT27	2 t_{inst}^*	—	μs	
Peripheral input "L" pulse width 2	t_{H2L2}		2 t_{inst}^*	—	μs	

* : For information on t_{inst} , see "(4) Instruction Cycle."

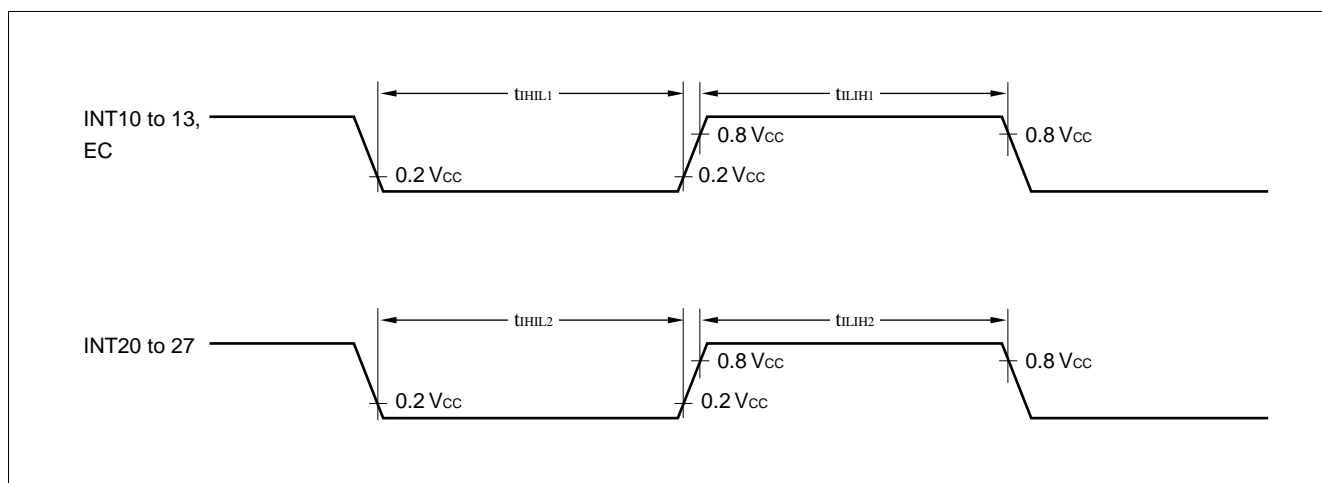

EXAMPLE CHARACTERISTICS

(1) "L" Level Output Voltage

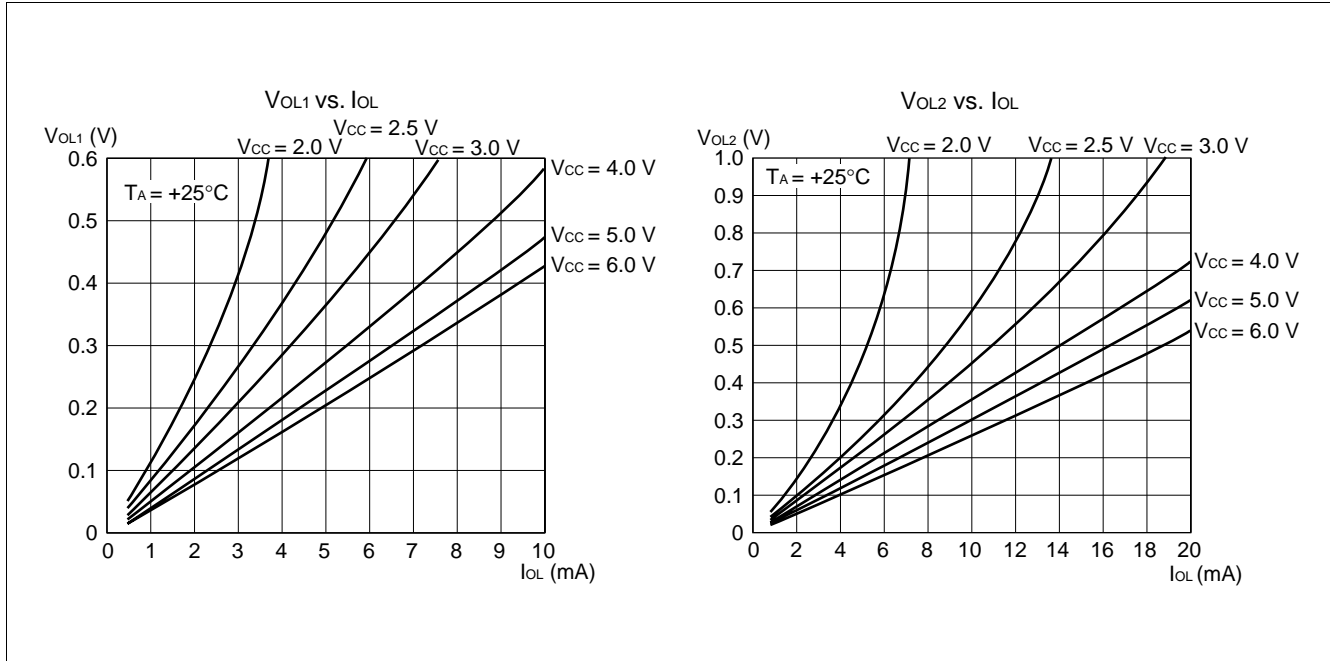

(2) "H" Level Output Voltage

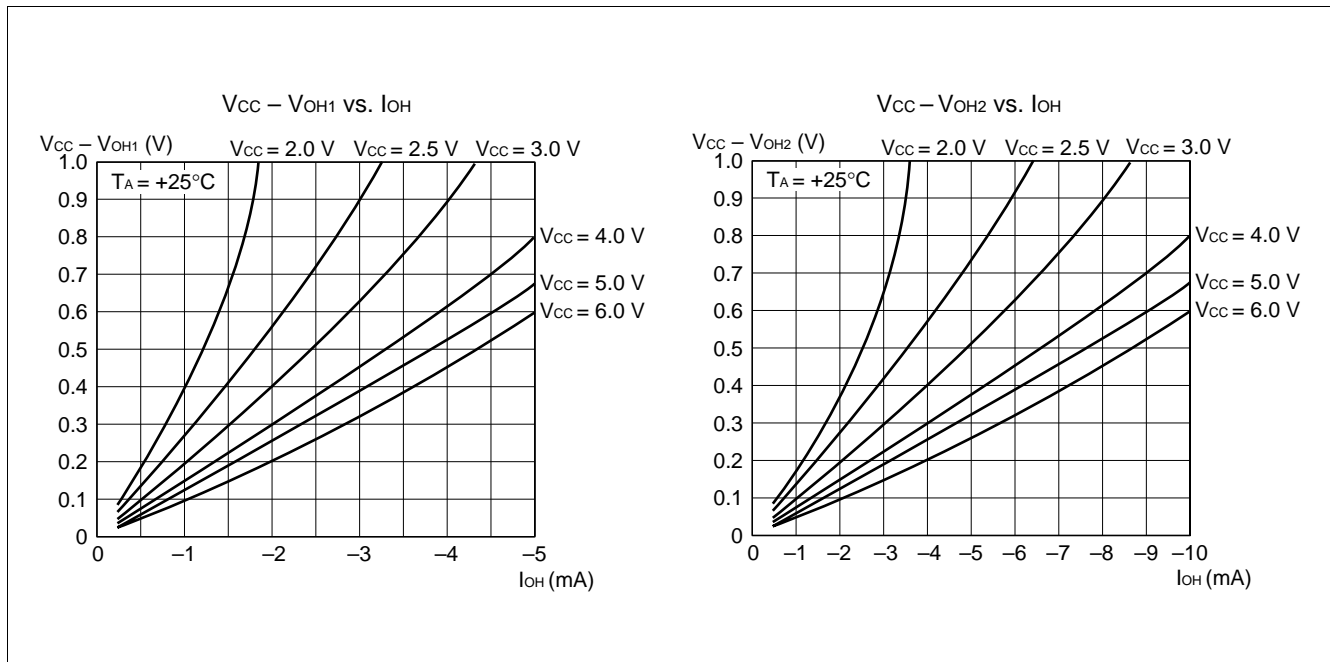

(Continued)

MB89150/150A Series

(3) "H" Level Input Voltage/"L" level Input Voltage

(CMOS input)

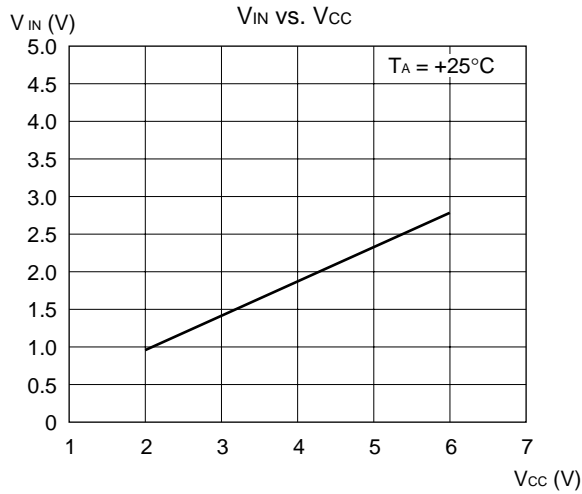

(Hysteresis input)

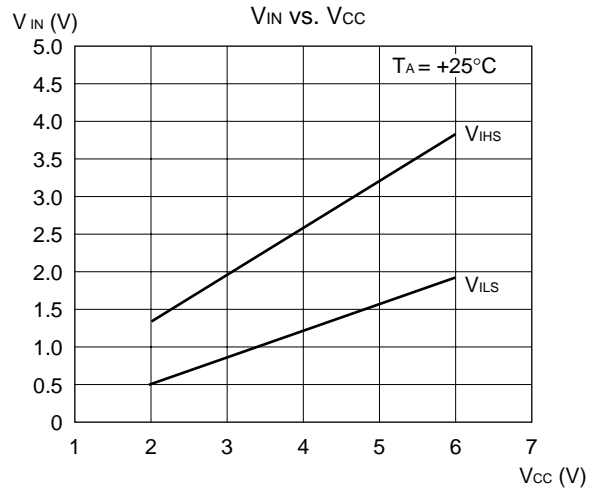

V_{IHS}: Threshold when input voltage in hysteresis characteristics is set to "H" level

V_{ILS}: Threshold when input voltage in hysteresis characteristics is set to "L" level

(4) Power Supply Current (External Clock)

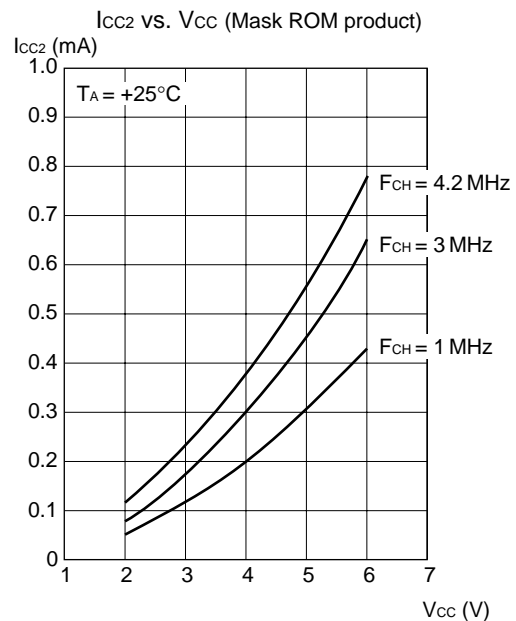
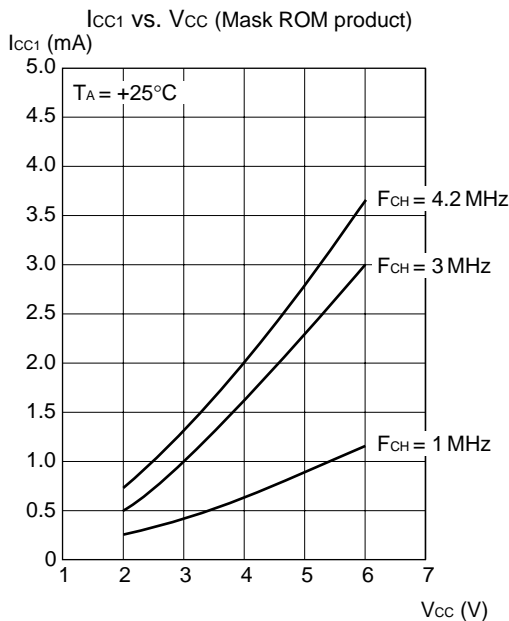

(Continued)

MB89150/150A Series

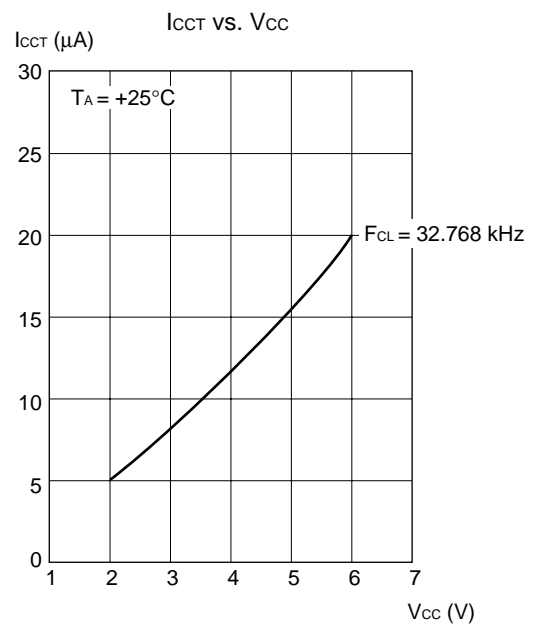
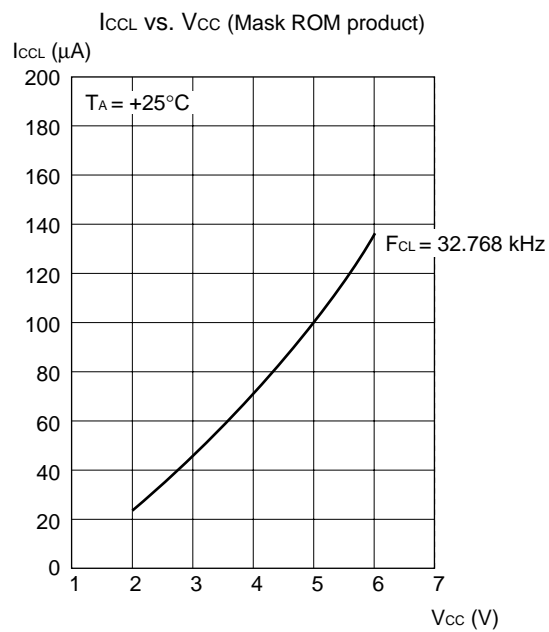
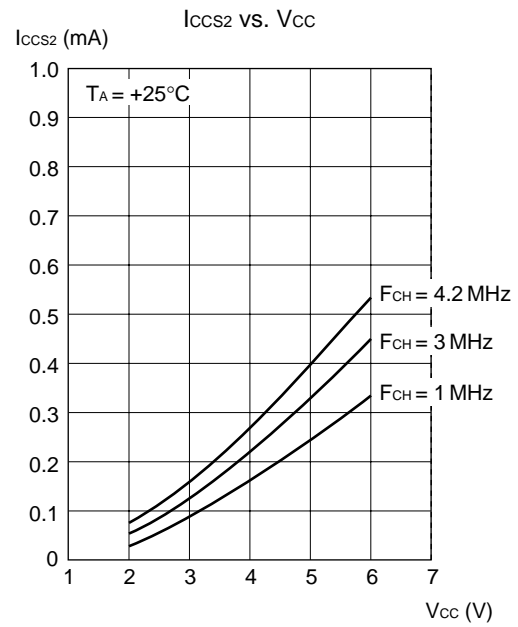
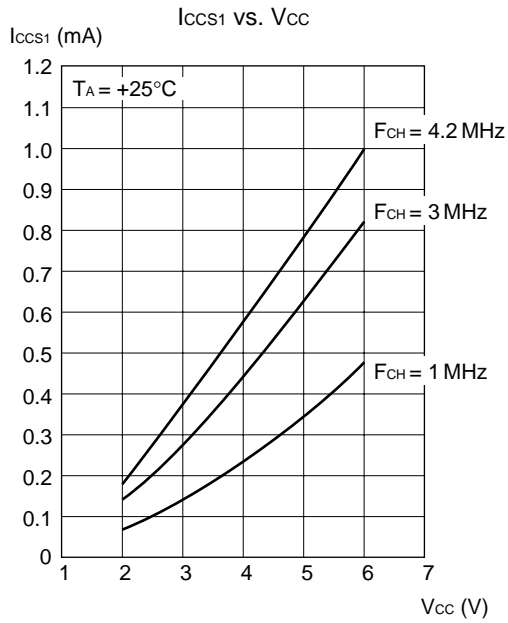

(Continued)

MB89150/150A Series

(Continued)

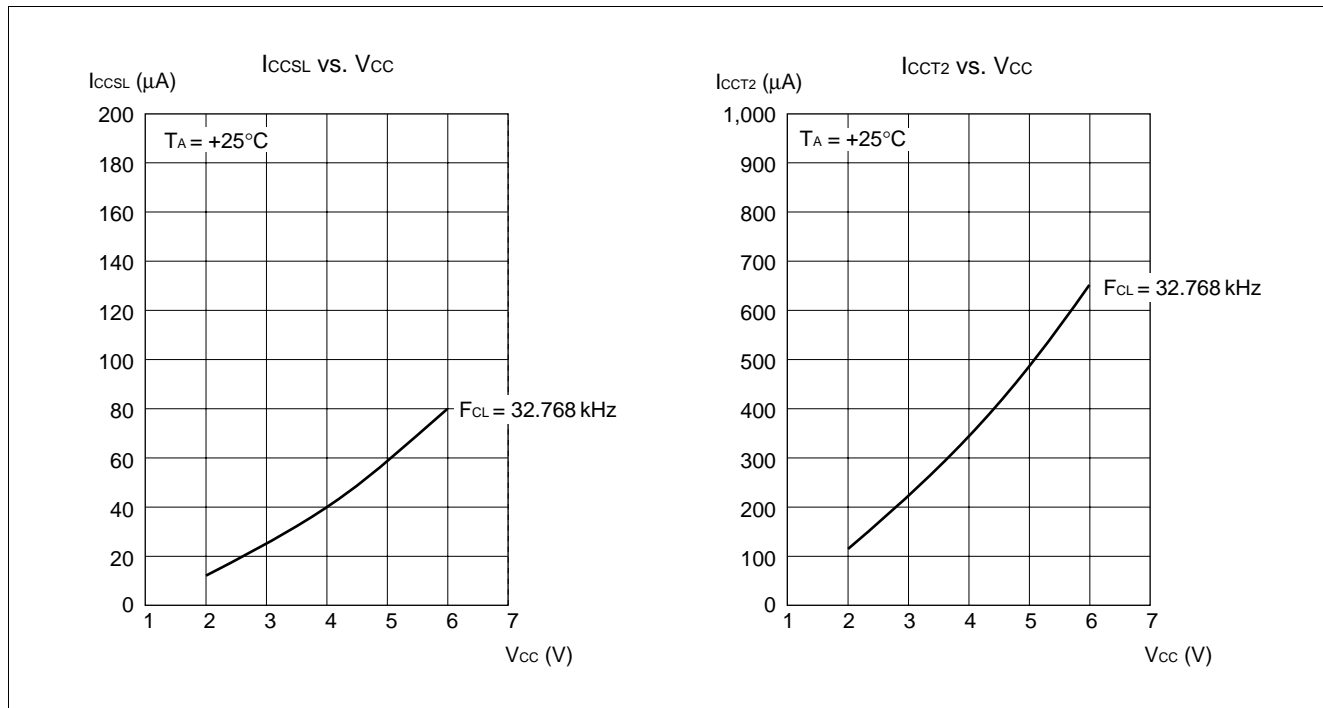

(5) Pull-up Resistance

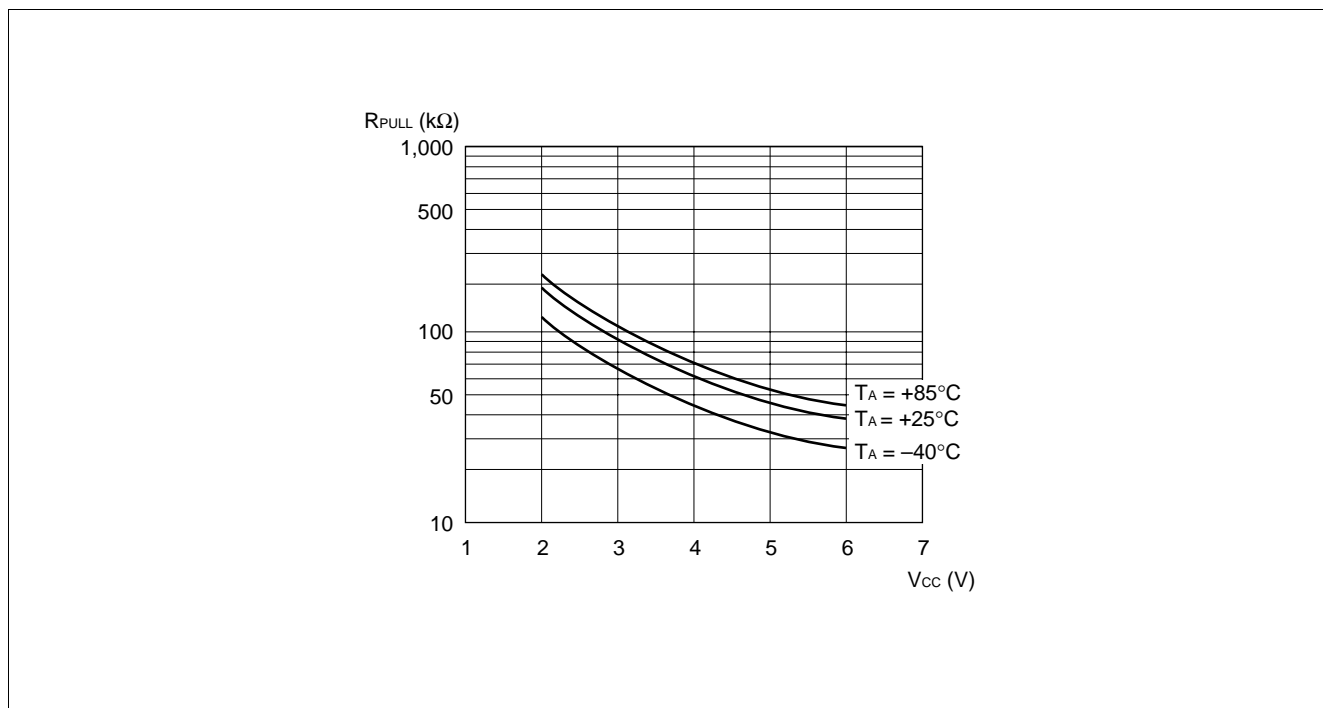

■ INSTRUCTIONS

Execution instructions can be divided into the following four groups:

- Transfer
- Arithmetic operation
- Branch
- Others

Table 1 lists symbols used for notation of instructions.

Table 1 Instruction Symbols

Symbol	Meaning
dir	Direct address (8 bits)
off	Offset (8 bits)
ext	Extended address (16 bits)
#vct	Vector table number (3 bits)
#d8	Immediate data (8 bits)
#d16	Immediate data (16 bits)
dir: b	Bit direct address (8:3 bits)
rel	Branch relative address (8 bits)
@	Register indirect (Example: @A, @IX, @EP)
A	Accumulator A (Whether its length is 8 or 16 bits is determined by the instruction in use.)
AH	Upper 8 bits of accumulator A (8 bits)
AL	Lower 8 bits of accumulator A (8 bits)
T	Temporary accumulator T (Whether its length is 8 or 16 bits is determined by the instruction in use.)
TH	Upper 8 bits of temporary accumulator T (8 bits)
TL	Lower 8 bits of temporary accumulator T (8 bits)
IX	Index register IX (16 bits)

(Continued)

MB89150/150A Series

(Continued)

Symbol	Meaning
EP	Extra pointer EP (16 bits)
PC	Program counter PC (16 bits)
SP	Stack pointer SP (16 bits)
PS	Program status PS (16 bits)
dr	Accumulator A or index register IX (16 bits)
CCR	Condition code register CCR (8 bits)
RP	Register bank pointer RP (5 bits)
Ri	General-purpose register Ri (8 bits, i = 0 to 7)
×	Indicates that the very × is the immediate data. (Whether its length is 8 or 16 bits is determined by the instruction in use.)
(×)	Indicates that the contents of × is the target of accessing. (Whether its length is 8 or 16 bits is determined by the instruction in use.)
((×))	The address indicated by the contents of × is the target of accessing. (Whether its length is 8 or 16 bits is determined by the instruction in use.)

Columns indicate the following:

Mnemonic: Assembler notation of an instruction

~: Number of instructions

#: Number of bytes

Operation: Operation of an instruction

TL, TH, AH: A content change when each of the TL, TH, and AH instructions is executed. Symbols in the column indicate the following:

- “–” indicates no change.
- dH is the 8 upper bits of operation description data.
- AL and AH must become the contents of AL and AH immediately before the instruction is executed.
- 00 becomes 00.

N, Z, V, C: An instruction of which the corresponding flag will change. If + is written in this column, the relevant instruction will change its corresponding flag.

OP code: Code of an instruction. If an instruction is more than one code, it is written according to the following rule:

Example: 48 to 4F ← This indicates 48, 49, ... 4F.

Table 2 Transfer Instructions (48 instructions)

Mnemonic	~	#	Operation	TL	TH	AH	NZVC	OP code
MOV dir,A	3	2	(dir) ← (A)	-	-	-	----	45
MOV @IX +off,A	4	2	((IX) +off) ← (A)	-	-	-	----	46
MOV ext,A	4	3	(ext) ← (A)	-	-	-	----	61
MOV @EP,A	3	1	((EP)) ← (A)	-	-	-	----	47
MOV Ri,A	3	1	(Ri) ← (A)	-	-	-	----	48 to 4F
MOV A,#d8	2	2	(A) ← d8	AL	-	-	++--	04
MOV A,dir	3	2	(A) ← (dir)	AL	-	-	++--	05
MOV A,@IX +off	4	2	(A) ← ((IX) +off)	AL	-	-	++--	06
MOV A,ext	4	3	(A) ← (ext)	AL	-	-	++--	60
MOV A,@A	3	1	(A) ← ((A))	AL	-	-	++--	92
MOV A,@EP	3	1	(A) ← ((EP))	AL	-	-	++--	07
MOV A,Ri	3	1	(A) ← (Ri)	AL	-	-	++--	08 to 0F
MOV dir,#d8	4	3	(dir) ← d8	-	-	-	----	85
MOV @IX +off,#d8	5	3	((IX) +off) ← d8	-	-	-	----	86
MOV @EP,#d8	4	2	((EP)) ← d8	-	-	-	----	87
MOV Ri,#d8	4	2	(Ri) ← d8	-	-	-	----	88 to 8F
MOVW dir,A	4	2	(dir) ← (AH),(dir + 1) ← (AL)	-	-	-	----	D5
MOVW @IX +off,A	5	2	((IX) +off) ← (AH), ((IX) +off + 1) ← (AL)	-	-	-	----	D6
MOVW ext,A	5	3	(ext) ← (AH),(ext + 1) ← (AL)	-	-	-	----	D4
MOVW @EP,A	4	1	((EP)) ← (AH),(EP + 1) ← (AL)	-	-	-	----	D7
MOVW EP,A	2	1	(EP) ← (A)	-	-	-	----	E3
MOVW A,#d16	3	3	(A) ← d16	AL	AH	dH	++--	E4
MOVW A,dir	4	2	(AH) ← (dir),(AL) ← (dir + 1)	AL	AH	dH	++--	C5
MOVW A,@IX +off	5	2	(AH) ← ((IX) +off), (AL) ← ((IX) +off + 1)	AL	AH	dH	++--	C6
MOVW A,ext	5	3	(AH) ← (ext),(AL) ← (ext + 1)	AL	AH	dH	++--	C4
MOVW A,@A	4	1	(AH) ← ((A)),(AL) ← ((A) + 1)	AL	AH	dH	++--	93
MOVW A,@EP	4	1	(AH) ← ((EP)),(AL) ← ((EP) + 1)	AL	AH	dH	++--	C7
MOVW A,EP	2	1	(A) ← (EP)	-	-	dH	----	F3
MOVW EP,#d16	3	3	(EP) ← d16	-	-	-	----	E7
MOVW IX,A	2	1	(IX) ← (A)	-	-	-	----	E2
MOVW A,IX	2	1	(A) ← (IX)	-	-	dH	----	F2
MOVW SP,A	2	1	(SP) ← (A)	-	-	-	----	E1
MOVW A,SP	2	1	(A) ← (SP)	-	-	dH	----	F1
MOV @A,T	3	1	((A)) ← (T)	-	-	-	----	82
MOVW @A,T	4	1	((A)) ← (TH),(A + 1) ← (TL)	-	-	-	----	83
MOVW IX,#d16	3	3	(IX) ← d16	-	-	-	----	E6
MOVW A,PS	2	1	(A) ← (PS)	-	-	dH	----	70
MOVW PS,A	2	1	(PS) ← (A)	-	-	-	++++	71
MOVW SP,#d16	3	3	(SP) ← d16	-	-	-	----	E5
SWAP	2	1	(AH) ↔ (AL)	-	-	AL	----	10
SETB dir: b	4	2	(dir): b ← 1	-	-	-	----	A8 to AF
CLRB dir: b	4	2	(dir): b ← 0	-	-	-	----	A0 to A7
XCH A,T	2	1	(AL) ↔ (TL)	AL	-	-	----	42
XCHW A,T	3	1	(A) ↔ (T)	AL	AH	dH	----	43
XCHW A,EP	3	1	(A) ↔ (EP)	-	-	dH	----	F7
XCHW A,IX	3	1	(A) ↔ (IX)	-	-	dH	----	F6
XCHW A,SP	3	1	(A) ↔ (SP)	-	-	dH	----	F5
MOVW A,PC	2	1	(A) ← (PC)	-	-	dH	----	F0

- Notes:
- During byte transfer to A, T ← A is restricted to low bytes.
 - Operands in more than one operand instruction must be stored in the order in which their mnemonics are written. (Reverse arrangement of F²MC-8 family)

MB89150/150A Series

Table 3 Arithmetic Operation Instructions (62 instructions)

Mnemonic	~	#	Operation	TL	TH	AH	NZVC	OP code
ADDC A,Ri	3	1	$(A) \leftarrow (A) + (Ri) + C$	-	-	-	++++	28 to 2F
ADDC A,#d8	2	2	$(A) \leftarrow (A) + d8 + C$	-	-	-	++++	24
ADDC A,dir	3	2	$(A) \leftarrow (A) + (dir) + C$	-	-	-	++++	25
ADDC A,@IX +off	4	2	$(A) \leftarrow (A) + ((IX) + off) + C$	-	-	-	++++	26
ADDC A,@EP	3	1	$(A) \leftarrow (A) + ((EP)) + C$	-	-	-	++++	27
ADDCW A	3	1	$(A) \leftarrow (A) + (T) + C$	-	-	dH	++++	23
ADDC A	2	1	$(AL) \leftarrow (AL) + (TL) + C$	-	-	-	++++	22
SUBC A,Ri	3	1	$(A) \leftarrow (A) - (Ri) - C$	-	-	-	++++	38 to 3F
SUBC A,#d8	2	2	$(A) \leftarrow (A) - d8 - C$	-	-	-	++++	34
SUBC A,dir	3	2	$(A) \leftarrow (A) - (dir) - C$	-	-	-	++++	35
SUBC A,@IX +off	4	2	$(A) \leftarrow (A) - ((IX) + off) - C$	-	-	-	++++	36
SUBC A,@EP	3	1	$(A) \leftarrow (A) - ((EP)) - C$	-	-	-	++++	37
SUBCW A	3	1	$(A) \leftarrow (T) - (A) - C$	-	-	dH	++++	33
SUBC A	2	1	$(AL) \leftarrow (TL) - (AL) - C$	-	-	-	++++	32
INC Ri	4	1	$(Ri) \leftarrow (Ri) + 1$	-	-	-	+++-	C8 to CF
INCW EP	3	1	$(EP) \leftarrow (EP) + 1$	-	-	-	----	C3
INCW IX	3	1	$(IX) \leftarrow (IX) + 1$	-	-	-	----	C2
INCW A	3	1	$(A) \leftarrow (A) + 1$	-	-	dH	++--	C0
DEC Ri	4	1	$(Ri) \leftarrow (Ri) - 1$	-	-	-	+++-	D8 to DF
DECW EP	3	1	$(EP) \leftarrow (EP) - 1$	-	-	-	----	D3
DECW IX	3	1	$(IX) \leftarrow (IX) - 1$	-	-	-	----	D2
DECW A	3	1	$(A) \leftarrow (A) - 1$	-	-	dH	++--	D0
MULU A	19	1	$(A) \leftarrow (AL) \times (TL)$	-	-	dH	----	01
DIVU A	21	1	$(A) \leftarrow (T) / (AL), MOD \rightarrow (T)$	dL	00	00	----	11
ANDW A	3	1	$(A) \leftarrow (A) \wedge (T)$	-	-	dH	++R-	63
ORW A	3	1	$(A) \leftarrow (A) \vee (T)$	-	-	dH	++R-	73
XORW A	3	1	$(A) \leftarrow (A) \nabla (T)$	-	-	dH	++R-	53
CMP A	2	1	$(TL) - (AL)$	-	-	-	++++	12
CMPW A	3	1	$(T) - (A)$	-	-	-	++++	13
RORC A	2	1	$\boxed{\rightarrow C \rightarrow A}$	-	-	-	++-+	03
ROLC A	2	1	$\boxed{\leftarrow C \leftarrow A}$	-	-	-	++-+	02
CMP A,#d8	2	2	$(A) - d8$	-	-	-	++++	14
CMP A,dir	3	2	$(A) - (dir)$	-	-	-	++++	15
CMP A,@EP	3	1	$(A) - ((EP))$	-	-	-	++++	17
CMP A,@IX +off	4	2	$(A) - ((IX) + off)$	-	-	-	++++	16
CMP A,Ri	3	1	$(A) - (Ri)$	-	-	-	++++	18 to 1F
DAA	2	1	Decimal adjust for addition	-	-	-	++++	84
DAS	2	1	Decimal adjust for subtraction	-	-	-	++++	94
XOR A	2	1	$(A) \leftarrow (AL) \nabla (TL)$	-	-	-	++R-	52
XOR A,#d8	2	2	$(A) \leftarrow (AL) \nabla d8$	-	-	-	++R-	54
XOR A,dir	3	2	$(A) \leftarrow (AL) \nabla (dir)$	-	-	-	++R-	55
XOR A,@EP	3	1	$(A) \leftarrow (AL) \nabla ((EP))$	-	-	-	++R-	57
XOR A,@IX +off	4	2	$(A) \leftarrow (AL) \nabla ((IX) + off)$	-	-	-	++R-	56
XOR A,Ri	3	1	$(A) \leftarrow (AL) \nabla (Ri)$	-	-	-	++R-	58 to 5F
AND A	2	1	$(A) \leftarrow (AL) \wedge (TL)$	-	-	-	++R-	62
AND A,#d8	2	2	$(A) \leftarrow (AL) \wedge d8$	-	-	-	++R-	64
AND A,dir	3	2	$(A) \leftarrow (AL) \wedge (dir)$	-	-	-	++R-	65

(Continued)

MB89150/150A Series

(Continued)

Mnemonic	~	#	Operation	TL	TH	AH	NZVC	OP code
AND A,@EP	3	1	$(A) \leftarrow (AL) \wedge ((EP))$	-	-	-	++R-	67
AND A,@IX +off	4	2	$(A) \leftarrow (AL) \wedge ((IX) +off)$	-	-	-	++R-	66
AND A,Ri	3	1	$(A) \leftarrow (AL) \wedge (Ri)$	-	-	-	++R-	68 to 6F
OR A	2	1	$(A) \leftarrow (AL) \vee (TL)$	-	-	-	++R-	72
OR A,#d8	2	2	$(A) \leftarrow (AL) \vee d8$	-	-	-	++R-	74
OR A,dir	3	2	$(A) \leftarrow (AL) \vee (dir)$	-	-	-	++R-	75
OR A,@EP	3	1	$(A) \leftarrow (AL) \vee ((EP))$	-	-	-	++R-	77
OR A,@IX +off	4	2	$(A) \leftarrow (AL) \vee ((IX) +off)$	-	-	-	++R-	76
OR A,Ri	3	1	$(A) \leftarrow (AL) \vee (Ri)$	-	-	-	++R-	78 to 7F
CMP dir,#d8	5	3	$(dir) - d8$	-	-	-	++++	95
CMP @EP,#d8	4	2	$((EP)) - d8$	-	-	-	++++	97
CMP @IX +off,#d8	5	3	$((IX) +off) - d8$	-	-	-	++++	96
CMP Ri,#d8	4	2	$(Ri) - d8$	-	-	-	++++	98 to 9F
INCW SP	3	1	$(SP) \leftarrow (SP) + 1$	-	-	-	----	C1
DECW SP	3	1	$(SP) \leftarrow (SP) - 1$	-	-	-	----	D1

Table 4 Branch Instructions (17 instructions)

Mnemonic	~	#	Operation	TL	TH	AH	NZVC	OP code
BZ/BEQ rel	3	2	If $Z = 1$ then $PC \leftarrow PC + rel$	-	-	-	----	FD
BNZ/BNE rel	3	2	If $Z = 0$ then $PC \leftarrow PC + rel$	-	-	-	----	FC
BC/BLO rel	3	2	If $C = 1$ then $PC \leftarrow PC + rel$	-	-	-	----	F9
BNC/BHS rel	3	2	If $C = 0$ then $PC \leftarrow PC + rel$	-	-	-	----	F8
BN rel	3	2	If $N = 1$ then $PC \leftarrow PC + rel$	-	-	-	----	FB
BP rel	3	2	If $N = 0$ then $PC \leftarrow PC + rel$	-	-	-	----	FA
BLT rel	3	2	If $V \vee N = 1$ then $PC \leftarrow PC + rel$	-	-	-	----	FF
BGE rel	3	2	If $V \vee N = 0$ then $PC \leftarrow PC + rel$	-	-	-	----	FE
BBC dir: b,rel	5	3	If $(dir: b) = 0$ then $PC \leftarrow PC + rel$	-	-	-	-+--	B0 to B7
BBS dir: b,rel	5	3	If $(dir: b) = 1$ then $PC \leftarrow PC + rel$	-	-	-	-+--	B8 to BF
JMP @A	2	1	$(PC) \leftarrow (A)$	-	-	-	----	E0
JMP ext	3	3	$(PC) \leftarrow ext$	-	-	-	----	21
CALLV #vct	6	1	Vector call	-	-	-	----	E8 to EF
CALL ext	6	3	Subroutine call	-	-	-	----	31
XCHW A,PC	3	1	$(PC) \leftarrow (A), (A) \leftarrow (PC) + 1$	-	-	dH	----	F4
RET	4	1	Return from subroutine	-	-	-	----	20
RETI	6	1	Return form interrupt	-	-	-	Restore	30

Table 5 Other Instructions (9 instructions)

Mnemonic	~	#	Operation	TL	TH	AH	NZVC	OP code
PUSHW A	4	1		-	-	-	----	40
POPW A	4	1		-	-	dH	----	50
PUSHW IX	4	1		-	-	-	----	41
POPW IX	4	1		-	-	-	----	51
NOP	1	1		-	-	-	----	00
CLRC	1	1		-	-	-	----R	81
SETC	1	1		-	-	-	----S	91
CLRI	1	1		-	-	-	----	80
SETI	1	1		-	-	-	----	90

MB89150/150A Series

INSTRUCTION MAP

L	H	0	1	2	3	4	5	6	7	8	9	A	B	C	D	E	F
0	NOP	SWAP A	RET	RETI	PUSHW A	POPW A	MOV A,ext	MOV A,PS	MOVW A,PS	CLRI	SETI	CLRB dir: 0	BBC dir: 0,rel	INCW A	DECW A	JMP @A	MOVW A,PC
1	MULU A	DIVU A	JMP addr16	CALL addr16	PUSHW IX	POPW IX	MOV ext,A	MOV PS,A	MOVW PS,A	CLRC	SETC	CLRB dir: 1	BBC dir: 1,rel	INCW SP	DECW SP	MOVW SPA	MOVW A,SP
2	ROLC A	CMP A	ADDC A	SUBC A	XCH A,T	XOR A	AND A	OR A	OR A	MOV @A,T	MOV A,@A	CLRB dir: 2	BBC dir: 2,rel	INCW IX	DECW IX	MOVW IX,A	MOVW A,IX
3	RORC A	CMPW A	ADDCW A	SUBCW A	XCHW A,T	XORW A	ANDW A	ORW A	ORW A	MOVW @A,T	MOVW A,@A	CLRB dir: 3	BBC dir: 3,rel	INCW EP	DECW EP	MOVW EPA	MOVW A,EP
4	MOV A,#d8	CMP A,#d8	ADDC A,#d8	SUBC A,#d8	XOR A,#d8	XOR A,#d8	AND A,#d8	OR A,#d8	OR A,#d8	DAA	DAS	CLRB dir: 4	BBC dir: 4,rel	MOVW A,ext	MOVW ext,A	MOVW A,#d16	XCHW A,PC
5	MOV A,dir	CMP A,dir	ADDC A,dir	SUBC A,dir	MOV dir,A	XOR A,dir	AND A,dir	OR A,dir	OR A,dir	MOV dir,#d8	CMP dir,#d8	CLRB dir: 5	BBC dir: 5,rel	MOVW A,dir	MOVW dir,A	MOVW SP,#d16	XCHW A,SP
6	MOV A,@IX+ d	CMP A,@IX+ d	ADDC A,@IX+ d	SUBC A,@IX+ d	MOV @IX+ d,A	XOR A,@IX+ d	AND A,@IX+ d	OR A,@IX+ d	OR A,@IX+ d	MOV @IX+ d,#d8	CMP @IX+ d,#d8	CLRB dir: 6	BBC dir: 6,rel	MOVW A,@IX+ d	MOVW @IX+ d,A	MOVW IX,#d16	XCHW A,IX
7	MOV A,@EP	CMP A,@EP	ADDC A,@EP	SUBC A,@EP	MOV @EP,A	XOR A,@EP	AND A,@EP	OR A,@EP	OR A,@EP	MOV @EP,#d8	CMP @EP,#d8	CLRB dir: 7	BBC dir: 7,rel	MOVW A,@EP	MOVW @EP,A	MOVW EP,#d16	XCHW A,EP
8	MOV A,R0	CMP A,R0	ADDC A,R0	SUBC A,R0	MOV R0,A	XOR A,R0	AND A,R0	OR A,R0	OR A,R0	MOV R0,#d8	CMP R0,#d8	SETB dir: 0	BBS dir: 0,rel	INC R0	DEC R0	CALLV #0	BNC rel
9	MOV A,R1	CMP A,R1	ADDC A,R1	SUBC A,R1	MOV R1,A	XOR A,R1	AND A,R1	OR A,R1	OR A,R1	MOV R1,#d8	CMP R1,#d8	SETB dir: 1	BBS dir: 1,rel	INC R1	DEC R1	CALLV #1	BC rel
A	MOV A,R2	CMP A,R2	ADDC A,R2	SUBC A,R2	MOV R2,A	XOR A,R2	AND A,R2	OR A,R2	OR A,R2	MOV R2,#d8	CMP R2,#d8	SETB dir: 2	BBS dir: 2,rel	INC R2	DEC R2	CALLV #2	BP rel
B	MOV A,R3	CMP A,R3	ADDC A,R3	SUBC A,R3	MOV R3,A	XOR A,R3	AND A,R3	OR A,R3	OR A,R3	MOV R3,#d8	CMP R3,#d8	SETB dir: 3	BBS dir: 3,rel	INC R3	DEC R3	CALLV #3	BN rel
C	MOV A,R4	CMP A,R4	ADDC A,R4	SUBC A,R4	MOV R4,A	XOR A,R4	AND A,R4	OR A,R4	OR A,R4	MOV R4,#d8	CMP R4,#d8	SETB dir: 4	BBS dir: 4,rel	INC R4	DEC R4	CALLV #4	BNZ rel
D	MOV A,R5	CMP A,R5	ADDC A,R5	SUBC A,R5	MOV R5,A	XOR A,R5	AND A,R5	OR A,R5	OR A,R5	MOV R5,#d8	CMP R5,#d8	SETB dir: 5	BBS dir: 5,rel	INC R5	DEC R5	CALLV #5	BZ rel
E	MOV A,R6	CMP A,R6	ADDC A,R6	SUBC A,R6	MOV R6,A	XOR A,R6	AND A,R6	OR A,R6	OR A,R6	MOV R6,#d8	CMP R6,#d8	SETB dir: 6	BBS dir: 6,rel	INC R6	DEC R6	CALLV #6	BGE rel
F	MOV A,R7	CMP A,R7	ADDC A,R7	SUBC A,R7	MOV R7,A	XOR A,R7	AND A,R7	OR A,R7	OR A,R7	MOV R7,#d8	CMP R7,#d8	SETB dir: 7	BBS dir: 7,rel	INC R7	DEC R7	CALLV #7	BLT rel

MB89150/150A Series

■ MASK OPTIONS

No.	Part number	MB89151/1A, 2/2A, 3/3A, 4/4A, 5/5A	MB89P155	MB89PV150
	Specifying procedure	Specify when ordering masking	Set with EPROM programmer	Setting not possible
1	Pull-up resistors P00 to P07, P10 to P17	Selectable per pin	Can be set per pin	Fixed to without a pull-up resistor
2	Pull-up resistors P40 to P47, P50 to P57	Selectable per pin (Only when segment output is not selected.)	Fixed to without a pull-up resistor	
3	Pull-up resistors P20 to P27	Selectable by pin	Fixed to without a pull-up resistor	
4	Power-on reset <ul style="list-style-type: none"> ┌ With power-on reset └ Without power-on reset 	Selectable	Selectable	Fixed to with power-on reset
5	Selection of oscillation stabilization time <ul style="list-style-type: none"> • The initial value of the oscillation stabilization time for the main clock can be set by selecting the values of the WTM1 and WTM0 bits on the right. 	Selectable WTM1 WTM0 0 0: $2^2/F_{CH}$ 0 1: $2^{12}/F_{CH}$ 1 0: $2^{16}/F_{CH}$ 1 1: $2^{18}/F_{CH}$	Selectable WTM1 WTM0 0 0: $2^2/F_{CH}$ 0 1: $2^{12}/F_{CH}$ 1 0: $2^{16}/F_{CH}$ 1 1: $2^{18}/F_{CH}$	Fixed to oscillation stabilization time of $2^{16}/F_{CH}$
6	Main clock oscillation type <ul style="list-style-type: none"> ┌ Crystal or ceramic resonator └ CR 	Selectable	Fixed to crystal or ceramic only	Fixed to crystal or ceramic
7	Reset pin output <ul style="list-style-type: none"> ┌ With reset output └ Without reset output 	Selectable	Selectable	Fixed to with reset output
8	Clock mode selection <ul style="list-style-type: none"> ┌ Dual-clock mode └ Single-clock mode 	Selectable	Selectable	Fixed to dual-clock mode
9	Segment output selection 36: No ports selection 32: Selection of P57 to P54 28: Selection of P57 to P50 24: Selection of P57 to P50, and P47 to P44. 20: Selection of P57 to P50, and P47 to P40.	Selectable Selection of the number of segments.	-101/201: 36 segments -102/202: 32 segments -103/203: 28 segments -104/204: 24 segments -105/205: 20 segments	-101: 36 segments -102: 32 segments -103: 28 segments -104: 24 segments -105: 20 segments
10	Selection of a built-in booster	Without booster: MB89151/2/3/4/5 With booster: MB89151A/2A/3A/4A/5A	Without booster: -101 to 105 With booster: -201 to 205	Fixed to without booster (-100 to 105 only)

MB89150/150A Series

• Versions

Version			Features	
Mass production product	One-time PROM product	Piggyback/evaluation product	Number of segment pins	Booster
MB8915151A	MB89P155-201	—	36	Yes
152A	-202		32	
153A	-203		28	
154A	-204		24	
155A	-205		20	
MB8915151	MB89P155-101	MB89PV150-101	36	No
152	-102	-102	32	
153	-103	-103	28	
154	-104	-104	24	
155	-105	-105	20	

■ ORDERING INFORMATION

Part number	Package	Remarks
MB89151PF MB89152PF MB89153PF MB89154PF MB89155PF MB89P155PF-101 MB89P155PF-102 MB89P155PF-103 MB89P155PF-104 MB89P155PF-105	80-pin Plastic QFP (FPT-80P-M06)	Without booster
MB89151APF MB89152APF MB89153APF MB89154APF MB89155APF MB89P155PF-201 MB89P155PF-202 MB89P155PF-203 MB89P155PF-204 MB89P155PF-205		With booster

(Continued)

MB89150/150A Series

(Continued)

Part number	Package	Remarks
MB89151PFM MB89152PFM MB89153PFM MB89154PFM MB89155PFM MB89P155PFM-101 MB89P155PFM-102 MB89P155PFM-103 MB89P155PFM-104 MB89P155PFM-105	80-pin Plastic LQFP (FPT-80P-M11)	Without booster
MB89151APFM MB89152APFM MB89153APFM MB89154APFM MB89155APFM MB89P155PFM-201 MB89P155PFM-202 MB89P155PFM-203 MB89P155PFM-204 MB89P155PFM-205		With booster
MB89151PFV MB89152PFV MB89153PFV MB89154PFV MB89155PFV MB89P155PFV-101 MB89P155PFV-102 MB89P155PFV-103 MB89P155PFV-104 MB89P155PFV-105	80-pin Plastic LQFP (FPT-80P-M05)	Without booster
MB89151APFV MB89152APFV MB89153APFV MB89154APFV MB89155APFV MB89P155PFV-201 MB89P155PFV-202 MB89P155PFV-203 MB89P155PFV-204 MB89P155PFV-205		With booster
MB89PV150CF-101 MB89PV150CF-102 MB89PV150CF-103 MB89PV150CF-104 MB89PV150CF-105	80-pin Ceramic MQFP (MQP-80C-P01)	Without booster

MB89150/150A Series

PACKAGE DIMENSIONS

80-pin Plastic QFP
(FPT-80P-M06)

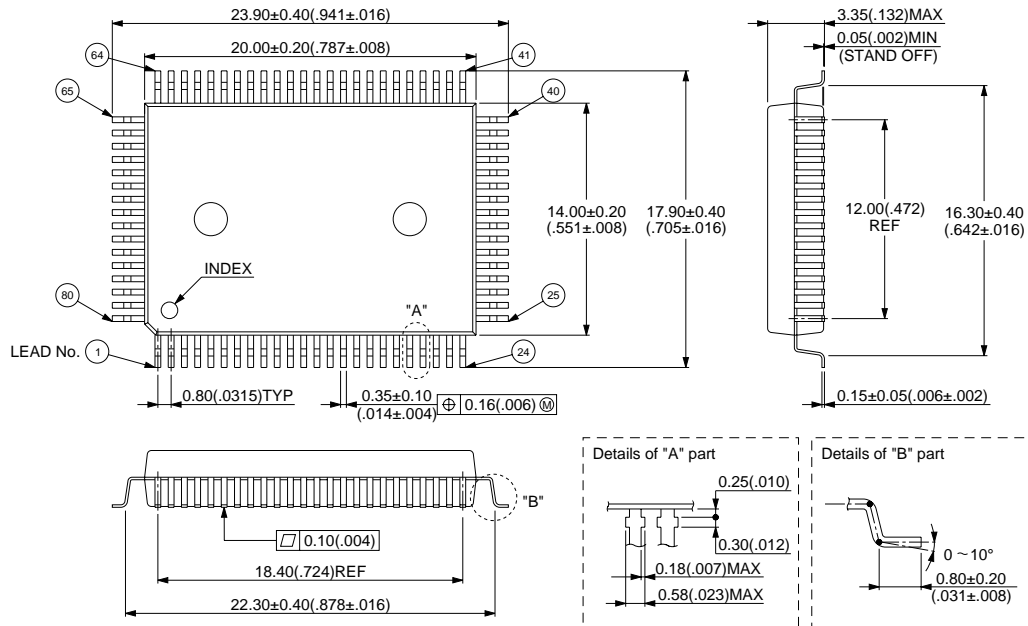

© 1994 FUJITSU LIMITED F80010S-3C-2

Dimensions in mm (inches)

80-pin Plastic LQFP
(FPT-80P-M11)

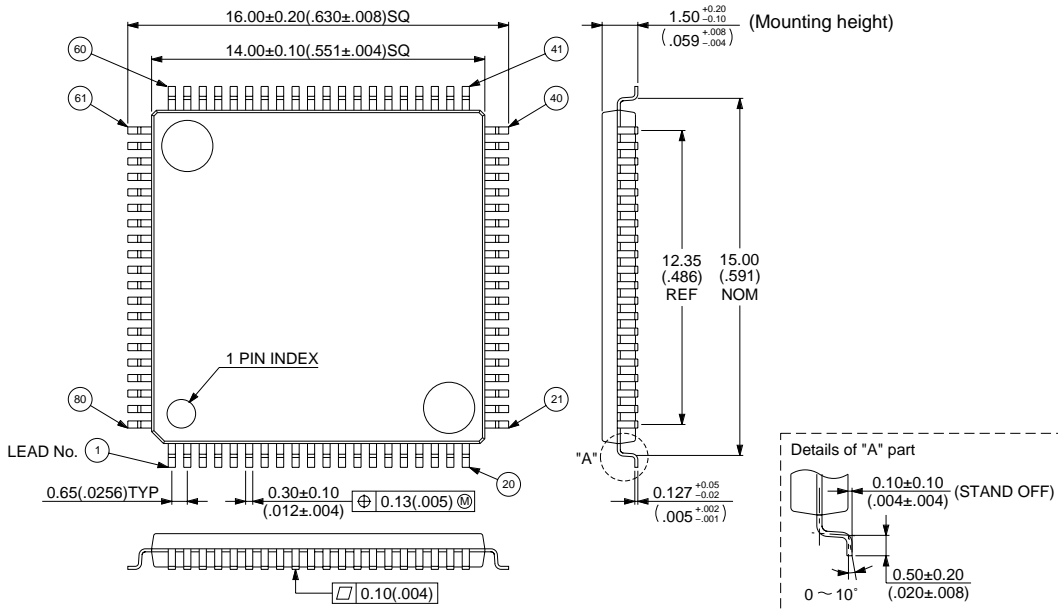

© 1995 FUJITSU LIMITED F80016S-1C-3

Dimensions in mm (inches)

MB89150/150A Series

80-pin Plastic LQFP (FPT-80P-M05)

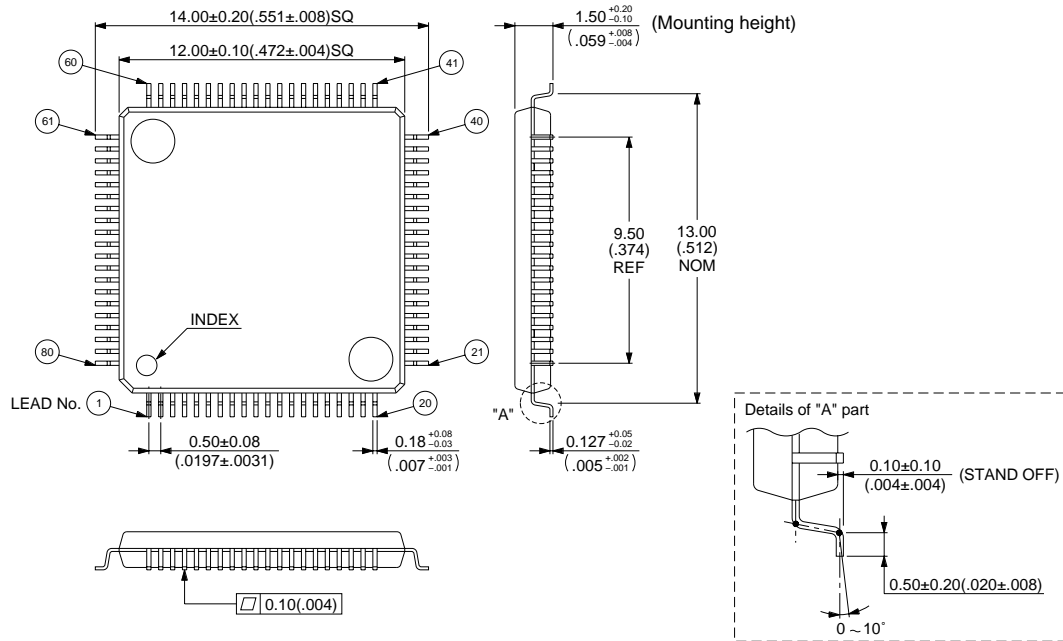

© 1995 FUJITSU LIMITED F80008S-2C-5

Dimensions in mm (inches)

80-pin Ceramic MQFP (MQP-80C-P01)

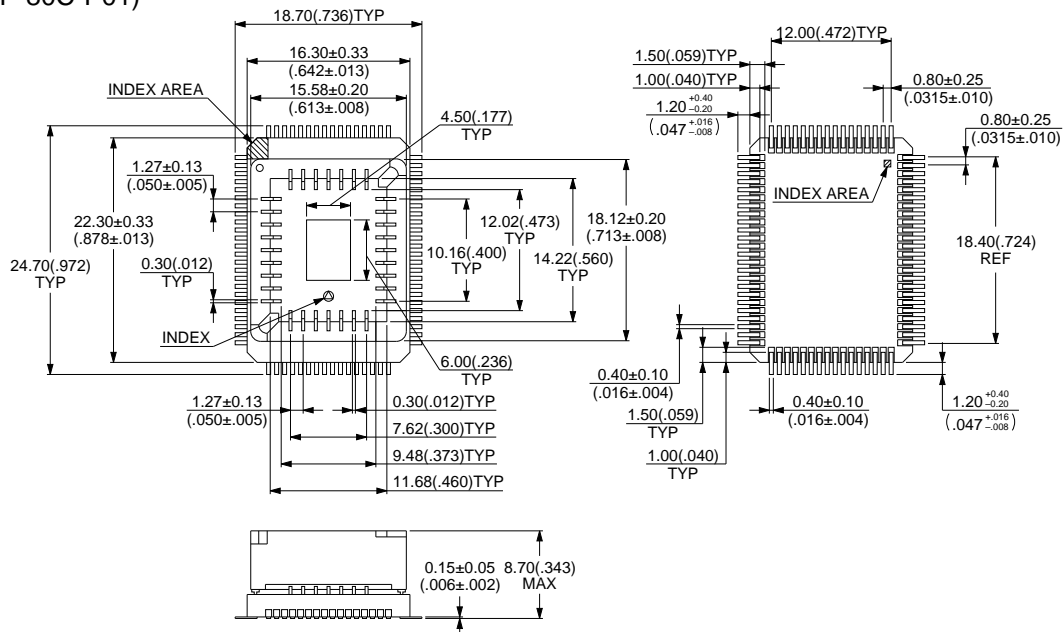

© 1994 FUJITSU LIMITED M80001SC-4-2

Dimensions in mm (inches)

MB89150/150A Series

FUJITSU LIMITED

For further information please contact:

Japan

FUJITSU LIMITED
Corporate Global Business Support Division
Electronic Devices
KAWASAKI PLANT, 4-1-1, Kamikodanaka
Nakahara-ku, Kawasaki-shi
Kanagawa 211-8588, Japan
Tel: (044) 754-3763
Fax: (044) 754-3329

<http://www.fujitsu.co.jp/>

North and South America

FUJITSU MICROELECTRONICS, INC.
Semiconductor Division
3545 North First Street
San Jose, CA 95134-1804, USA
Tel: (408) 922-9000
Fax: (408) 922-9179

Customer Response Center
Mon. - Fri.: 7 am - 5 pm (PST)
Tel: (800) 866-8608
Fax: (408) 922-9179

<http://www.fujitsumicro.com/>

Europe

FUJITSU MIKROELEKTRONIK GmbH
Am Siebenstein 6-10
D-63303 Dreieich-Buchsschlag
Germany
Tel: (06103) 690-0
Fax: (06103) 690-122

<http://www.fujitsu-edc.com/>

Asia Pacific

FUJITSU MICROELECTRONICS ASIA PTE LTD
#05-08, 151 Lorong Chuan
New Tech Park
Singapore 556741
Tel: (65) 281-0770
Fax: (65) 281-0220

<http://www.fmap.com.sg/>

F9804

© FUJITSU LIMITED Printed in Japan

All Rights Reserved.

The contents of this document are subject to change without notice. Customers are advised to consult with FUJITSU sales representatives before ordering.

The information and circuit diagrams in this document presented as examples of semiconductor device applications, and are not intended to be incorporated in devices for actual use. Also, FUJITSU is unable to assume responsibility for infringement of any patent rights or other rights of third parties arising from the use of this information or circuit diagrams.

FUJITSU semiconductor devices are intended for use in standard applications (computers, office automation and other office equipment, industrial, communications, and measurement equipment, personal or household devices, etc.).

CAUTION:

Customers considering the use of our products in special applications where failure or abnormal operation may directly affect human lives or cause physical injury or property damage, or where extremely high levels of reliability are demanded (such as aerospace systems, atomic energy controls, sea floor repeaters, vehicle operating controls, medical devices for life support, etc.) are requested to consult with FUJITSU sales representatives before such use. The company will not be responsible for damages arising from such use without prior approval.

Any semiconductor devices have inherently a certain rate of failure. You must protect against injury, damage or loss from such failures by incorporating safety design measures into your facility and equipment such as redundancy, fire protection, and prevention of over-current levels and other abnormal operating conditions.

If any products described in this document represent goods or technologies subject to certain restrictions on export under the Foreign Exchange and Foreign Trade Control Law of Japan, the prior authorization by Japanese government should be required for export of those products from Japan.