

# FM4003

Glass passivated type

## Features

- Plastic package has Underwriters Laboratory Flammability Classification 94V-O Utilizing Flame Retardant Epoxy Molding Compound.
- For surface mounted applications.
- Exceeds environmental standards of ML-S-19500 / 228
- Low leakage current.

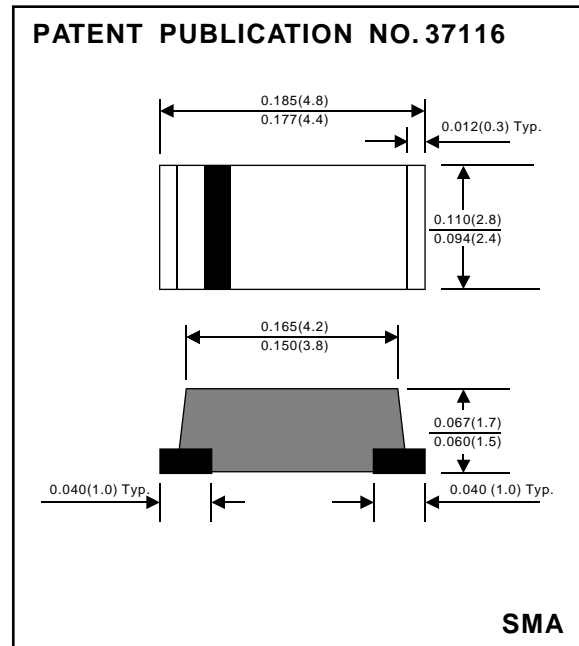

## Mechanical data

Case : Molded plastic, JEDEC DO-214AC

Terminals : Solder plated, solderable per MIL-STD-750, Method 2026

Polarity : Indicated by cathode band

Mounting Position : Any

Weight : 0.0015 ounce, 0.05 gram

MARKING CODE : A3

## MAXIMUM RATINGS (AT $T_A=25^{\circ}\text{C}$ unless otherwise noted)

PARAMETER	CONDITIONS	Symbol	MI N.	TYP.	MAX.	UNI T
Repetitive peak reverse voltage		$V_{RRM}$			200	V
RMS voltage		$V_{RMS}$			140	V
Continuous reverse voltage		$V_R$			200	V
Forward rectified current	Lead temperature = $70^{\circ}\text{C}$	$I_O$			1.0	A
Forward surge current	8.3ms single half sine-wave superimposed on rate load (JEDEC method)	$I_{FSM}$			30	A
Thermal resistance	Junction to ambient	$R_{\theta JA}$			100	$^{\circ}\text{C} / \text{w}$
Diode junction capacitance	$f=1\text{MHz}$ and applied 4VDC reverse voltage	$C_J$		15		pF
Operating temperature		$T_J$	-55		+150	$^{\circ}\text{C}$
Storage temperature		$T_{STG}$	-55		+150	$^{\circ}\text{C}$

## ELECTRICAL CHARACTERISTICS (AT $T_A=25^{\circ}\text{C}$ unless otherwise noted)

PARAMETER	CONDITIONS	Symbol	MI N.	TYP.	MAX.	UNI T
Forward voltage	$I_F = 1.0 \text{ AMPERE DC}$	$V_F$			1.10	V
Reverse current	$V_R = \text{Peak reverse voltage } T_A = 25^{\circ}\text{C}$	$I_R$			5	$\mu\text{A}$
	$V_R = \text{Peak reverse voltage } T_A = 125^{\circ}\text{C}$				50	$\mu\text{A}$