

S1A - S1M

Features

- Low profile package.
- Glass passivated junction.



SMA/DO-214AC
COLOR BAND DENOTES CATHODE

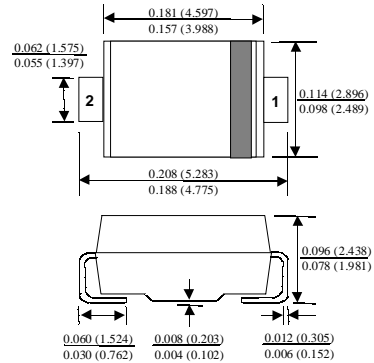

1.0 Ampere General Purpose Rectifiers

Absolute Maximum Ratings* $T_A = 25^\circ\text{C}$ unless otherwise noted

Symbol	Parameter	Value	Units
I_O	Average Rectified Current @ $T_A = 100^\circ\text{C}$	1.0	A
$i_{f(\text{surge})}$	Peak Forward Surge Current 8.3 ms single half-sine-wave Superimposed on rated load (JEDEC method)	40	A
P_D	Total Device Dissipation Derate above 25°C	1.4 11	W mW/ $^\circ\text{C}$
$R_{\theta JA}$	Thermal Resistance, Junction to Ambient **	85	$^\circ\text{C}/\text{W}$
T_{stg}	Storage Temperature Range	-55 to +150	$^\circ\text{C}$
T_J	Operating Junction Temperature	-55 to +150	$^\circ\text{C}$

* These ratings are limiting values above which the serviceability of any semiconductor device may be impaired.

** Device mounted on FR-4 PCB 0.013 mm.

Electrical Characteristics $T_A = 25^\circ\text{C}$ unless otherwise noted

Parameter	Device							Units	
	1A	1B	1D	1G	1J	1K	1M		
Peak Repetitive Reverse Voltage	50	100	200	400	600	800	1000	V	
Maximum RMS Voltage	35	70	140	280	420	560	700	V	
DC Reverse Voltage (Rated V_R)	50	100	200	400	600	800	1000	V	
Maximum Reverse Current @ rated V_R $T_A = 25^\circ\text{C}$ $T_A = 125^\circ\text{C}$								1.0 50	μA μA
Maximum Forward Voltage @ 1.0 A								1.1	V
Maximum Reverse Recovery Time $I_F = 0.5\text{ A}$, $I_R = 1.0\text{ A}$, $I_{rr} = 0.25\text{ A}$								1.8	μS
Typical Junction Capacitance $V_R = 4.0\text{ V}$, $f = 1.0\text{ MHz}$								12	pF

Typical Characteristics

Forward Current Derating Curve

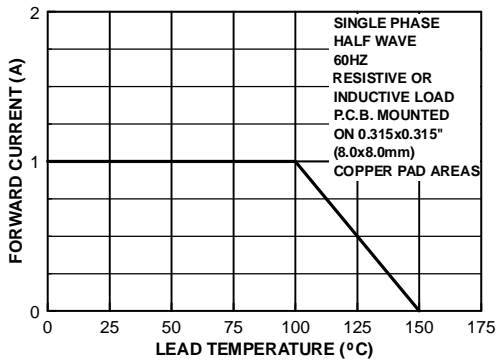

Forward Characteristics

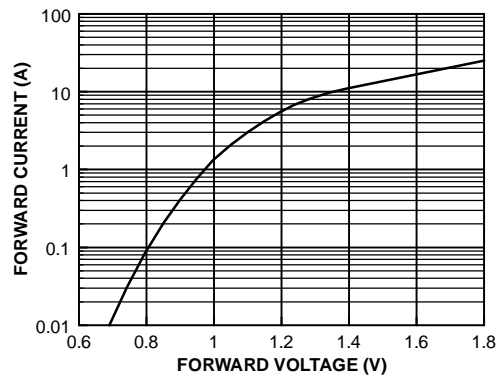

Non-Repetitive Surge Current

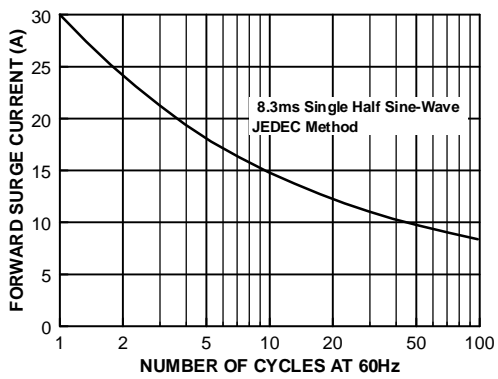

Reverse Characteristics

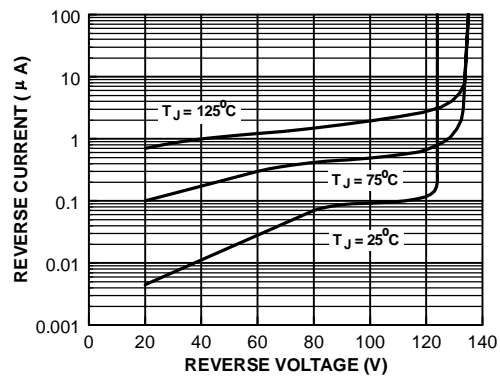

Junction Capacitance

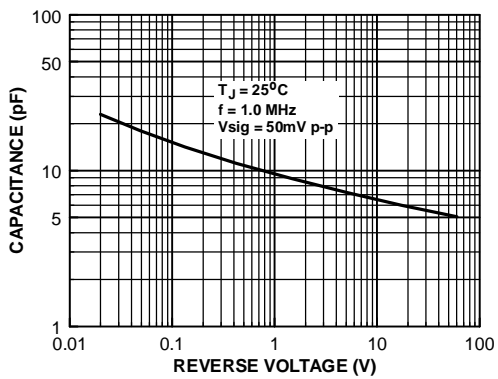

Thermal Impedance

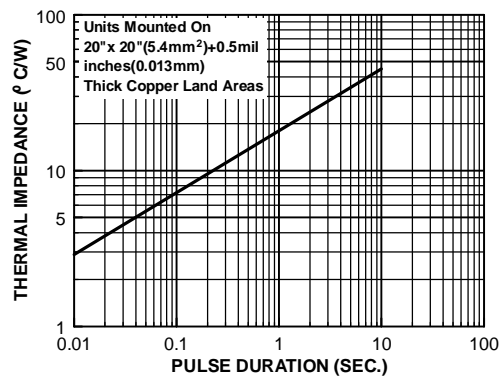

TRADEMARKS

The following are registered and unregistered trademarks Fairchild Semiconductor owns or is authorized to use and is not intended to be an exhaustive list of all such trademarks.

ACEx™	ISOPLANAR™
CoolFET™	MICROWIRE™
CROSSVOLT™	POP™
E ² CMOS™	PowerTrench™
FACT™	QS™
FACT Quiet Series™	Quiet Series™
FAST®	SuperSOT™-3
FASTr™	SuperSOT™-6
GTO™	SuperSOT™-8
HiSeC™	TinyLogic™

DISCLAIMER

FAIRCHILD SEMICONDUCTOR RESERVES THE RIGHT TO MAKE CHANGES WITHOUT FURTHER NOTICE TO ANY PRODUCTS HEREIN TO IMPROVE RELIABILITY, FUNCTION OR DESIGN. FAIRCHILD DOES NOT ASSUME ANY LIABILITY ARISING OUT OF THE APPLICATION OR USE OF ANY PRODUCT OR CIRCUIT DESCRIBED HEREIN; NEITHER DOES IT CONVEY ANY LICENSE UNDER ITS PATENT RIGHTS, NOR THE RIGHTS OF OTHERS.

LIFE SUPPORT POLICY

FAIRCHILD'S PRODUCTS ARE NOT AUTHORIZED FOR USE AS CRITICAL COMPONENTS IN LIFE SUPPORT DEVICES OR SYSTEMS WITHOUT THE EXPRESS WRITTEN APPROVAL OF FAIRCHILD SEMICONDUCTOR CORPORATION. As used herein:

1. Life support devices or systems are devices or systems which, (a) are intended for surgical implant into the body, or (b) support or sustain life, or (c) whose failure to perform when properly used in accordance with instructions for use provided in the labeling, can be reasonably expected to result in significant injury to the user.
2. A critical component is any component of a life support device or system whose failure to perform can be reasonably expected to cause the failure of the life support device or system, or to affect its safety or effectiveness.

PRODUCT STATUS DEFINITIONS

Definition of Terms

Datasheet Identification	Product Status	Definition
Advance Information	Formative or In Design	This datasheet contains the design specifications for product development. Specifications may change in any manner without notice.
Preliminary	First Production	This datasheet contains preliminary data, and supplementary data will be published at a later date. Fairchild Semiconductor reserves the right to make changes at any time without notice in order to improve design.
No Identification Needed	Full Production	This datasheet contains final specifications. Fairchild Semiconductor reserves the right to make changes at any time without notice in order to improve design.
Obsolete	Not In Production	This datasheet contains specifications on a product that has been discontinued by Fairchild semiconductor. The datasheet is printed for reference information only.