

## NDH8502P Dual P-Channel Enhancement Mode Field Effect Transistor

### General Description

SuperSOT™-8 P-Channel enhancement mode power field effect transistors are produced using Fairchild's proprietary, high cell density, DMOS technology. This very high density process is especially tailored to minimize on-state resistance. These devices are particularly suited for low voltage applications such as notebook computer power management and other battery powered circuits where fast high-side switching, and low in-line power loss are needed in a very small outline surface mount package.

### Features

- -2.2 A, -30 V.  $R_{DS(ON)} = 0.11 \Omega @ V_{GS} = -10 \text{ V}$   
 $R_{DS(ON)} = 0.18 \Omega @ V_{GS} = -4.5 \text{ V}$ .
- Proprietary SuperSOT™-8 package design using copper lead frame for superior thermal and electrical capabilities.
- High density cell design for extremely low  $R_{DS(ON)}$ .
- Exceptional on-resistance and maximum DC current capability.

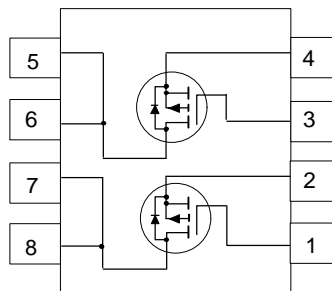
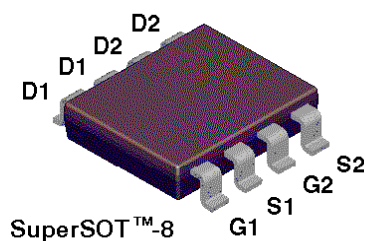

### Absolute Maximum Ratings $T_A = 25^\circ\text{C}$ unless otherwise noted

Symbol	Parameter		NDH8502P	Units
$V_{DSS}$	Drain-Source Voltage		-30	V
$V_{GSS}$	Gate-Source Voltage		$\pm 20$	V
$I_D$	Drain Current - Continuous	(Note 1)	-2.2	A
	- Pulsed		-10	
$P_D$	Maximum Power Dissipation	(Note 1)	0.8	W
$T_J, T_{STG}$	Operating and Storage Temperature Range		-55 to 150	$^\circ\text{C}$
<b>THERMAL CHARACTERISTICS</b>				
$R_{\theta JA}$	Thermal Resistance, Junction-to-Ambient	(Note 1)	156	$^\circ\text{C/W}$
$R_{\theta JC}$	Thermal Resistance, Junction-to-Case	(Note 1)	40	$^\circ\text{C/W}$

**ELECTRICAL CHARACTERISTICS** ( $T_A = 25^\circ\text{C}$  unless otherwise noted)

Symbol	Parameter	Conditions	Min	Typ	Max	Units	
<b>OFF CHARACTERISTICS</b>							
$BV_{DSS}$	Drain-Source Breakdown Voltage	$V_{GS} = 0\text{ V}, I_D = -250\ \mu\text{A}$	-30			V	
$I_{DSS}$	Zero Gate Voltage Drain Current	$V_{DS} = -24\text{ V}, V_{GS} = 0\text{ V}$			-1	$\mu\text{A}$	
			$T_J = 55^\circ\text{C}$			-10	$\mu\text{A}$
$I_{GSSF}$	Gate - Body Leakage, Forward	$V_{GS} = 20\text{ V}, V_{DS} = 0\text{ V}$			100	nA	
$I_{GSSR}$	Gate - Body Leakage, Reverse	$V_{GS} = -20\text{ V}, V_{DS} = 0\text{ V}$			-100	nA	
<b>ON CHARACTERISTICS</b> (Note 2)							
$V_{GS(th)}$	Gate Threshold Voltage	$V_{DS} = V_{GS}, I_D = -250\ \mu\text{A}$	-1	-1.5	-3	V	
			$T_J = 125^\circ\text{C}$	-0.8	-1.2	-2.2	
$R_{DS(on)}$	Static Drain-Source On-Resistance	$V_{GS} = -10\text{ V}, I_D = -2.2\text{ A}$		0.1	0.11	$\Omega$	
			$T_J = 125^\circ\text{C}$		0.14	0.2	
			$V_{GS} = -4.5\text{ V}, I_D = -1.7\text{ A}$		0.17	0.18	
$I_{D(on)}$	On-State Drain Current	$V_{GS} = -10\text{ V}, V_{DS} = -5\text{ V}$	-10			A	
			$V_{GS} = -4.5\text{ V}, V_{DS} = -5\text{ V}$	-4			
$g_{FS}$	Forward Transconductance	$V_{DS} = -10\text{ V}, I_D = -2.2\text{ A}$		3.8		S	
<b>DYNAMIC CHARACTERISTICS</b>							
$C_{iss}$	Input Capacitance	$V_{DS} = -15\text{ V}, V_{GS} = 0\text{ V},$ $f = 1.0\text{ MHz}$		340		pF	
$C_{oss}$	Output Capacitance			218		pF	
$C_{rss}$	Reverse Transfer Capacitance			100		pF	
<b>SWITCHING CHARACTERISTICS</b> (Note 2)							
$t_{D(on)}$	Turn - On Delay Time	$V_{DD} = -10\text{ V}, I_D = -1\text{ A},$ $V_{GS} = -10\text{ V}, R_{GEN} = 6\ \Omega$		8	15	ns	
$t_r$	Turn - On Rise Time			18	35	ns	
$t_{D(off)}$	Turn - Off Delay Time			28	50	ns	
$t_f$	Turn - Off Fall Time			20	35	ns	
$Q_g$	Total Gate Charge		$V_{DS} = -15\text{ V},$ $I_D = -2.2\text{ A}, V_{GS} = -10\text{ V}$		10.9	14.5	nC
$Q_{gs}$	Gate-Source Charge			1.4		nC	
$Q_{gd}$	Gate-Drain Charge			3.6		nC	

**ELECTRICAL CHARACTERISTICS** ( $T_A = 25^\circ\text{C}$  unless otherwise noted)

Symbol	Parameter	Conditions	Min	Typ	Max	Units
<b>DRAIN-SOURCE DIODE CHARACTERISTICS AND MAXIMUM RATINGS</b>						
$I_S$	Maximum Continuous Drain-Source Diode Forward Current				-0.67	A
$V_{SD}$	Drain-Source Diode Forward Voltage	$V_{GS} = 0\text{ V}$ , $I_S = -0.67\text{ A}$ (Note 2)		-0.76	-1.2	V

Notes:

- $R_{\theta JA}$  is the sum of the junction-to-case and case-to-ambient thermal resistance where the case thermal reference is defined as the solder mounting surface of the drain pins.  $R_{\theta JC}$  is guaranteed by design while  $R_{\theta CA}$  is determined by the user's board design.

$$P_D(t) = \frac{T_J - T_A}{R_{\theta J, D}(t)} = \frac{T_J - T_A}{R_{\theta JC} + R_{\theta CA}(t)} = I_D^2(t) \times R_{DS(ON)} @ T_J$$

Typical  $R_{\theta JA}$  using the board layouts shown below on 4.5"x5" FR-4 PCB in a still air environment:

156°C/W when mounted on a 0.0025 in<sup>2</sup> pad of 2oz copper.

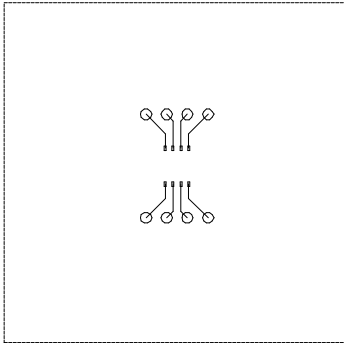

Scale 1 : 1 on letter size paper

- Pulse Test: Pulse Width  $\leq 300\mu\text{s}$ , Duty Cycle  $\leq 2.0\%$ .

## Typical Electrical Characteristics

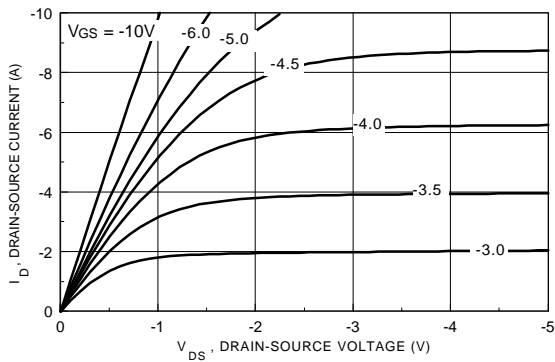

Figure 1. On-Region Characteristics.

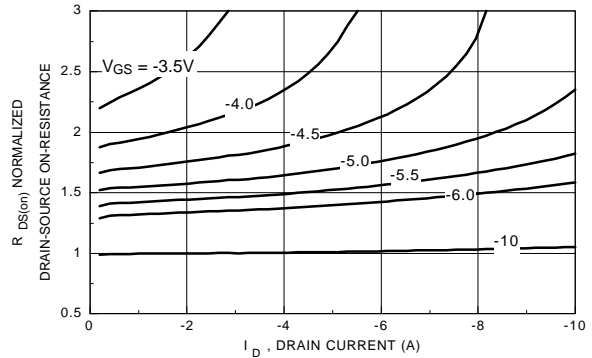

Figure 2. On-Resistance Variation with Gate Voltage and Drain Current.

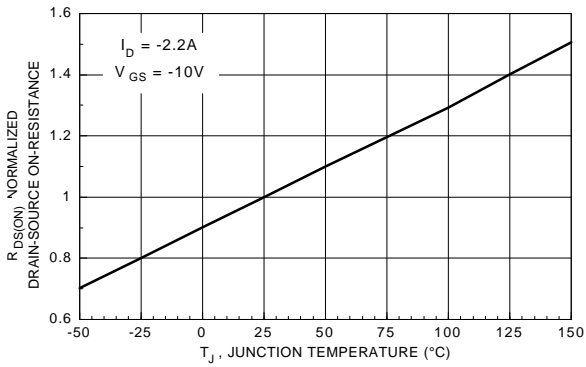

Figure 3. On-Resistance Variation with Temperature.

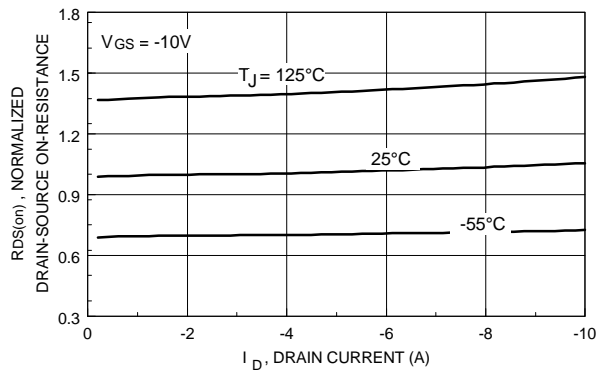

Figure 4. On-Resistance Variation with Drain Current and Temperature.

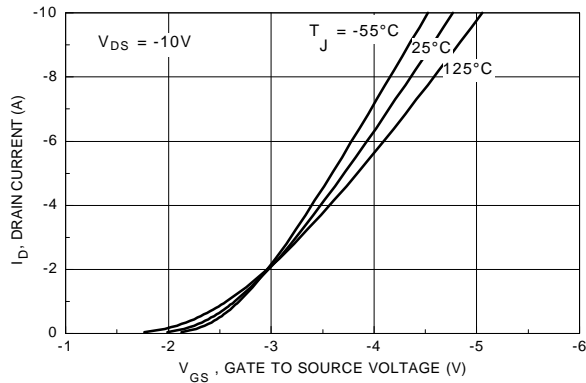

Figure 5. Transfer Characteristics.

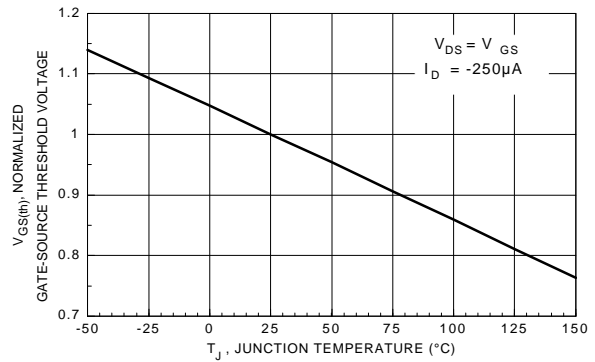

Figure 6. Gate Threshold Variation with Temperature.

## Typical Electrical Characteristics

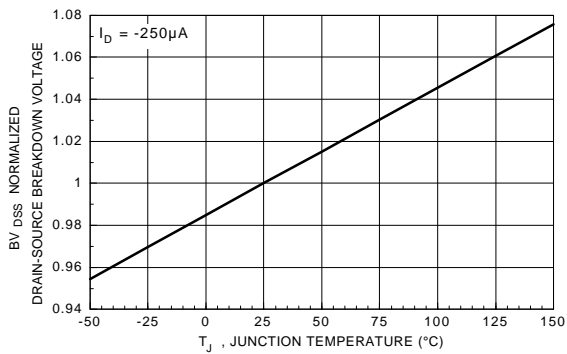

Figure 7. Breakdown Voltage Variation with Temperature.

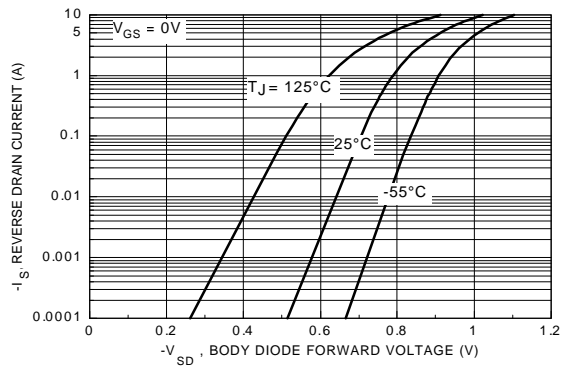

Figure 8. Body Diode Forward Voltage Variation with Current and Temperature.

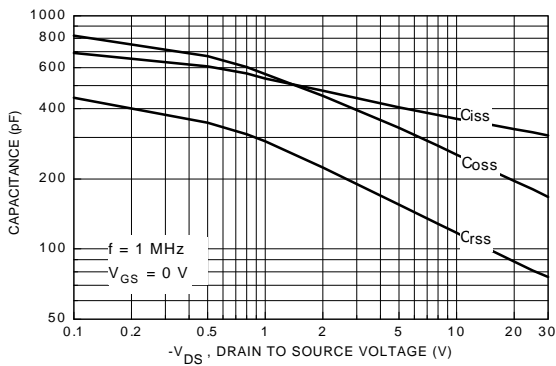

Figure 9. Capacitance Characteristics.

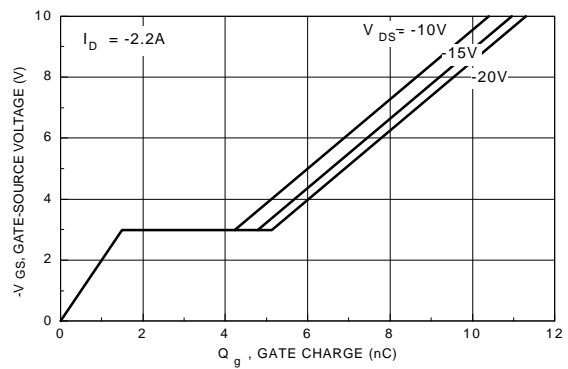

Figure 10. Gate Charge Characteristics.

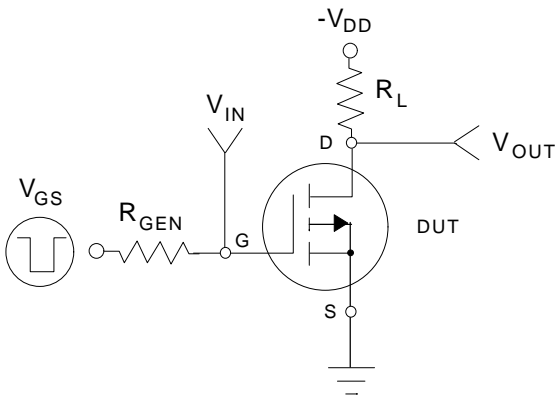

Figure 11. Switching Test Circuit.

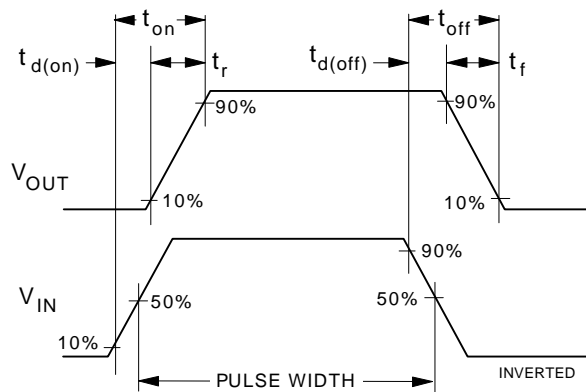
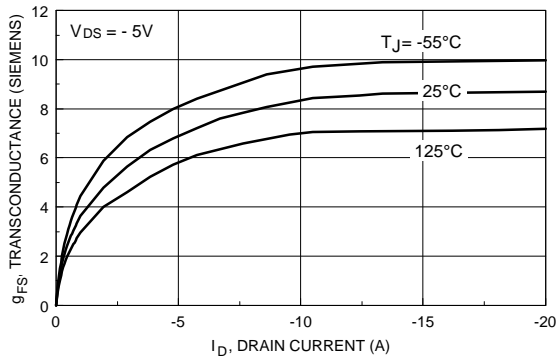
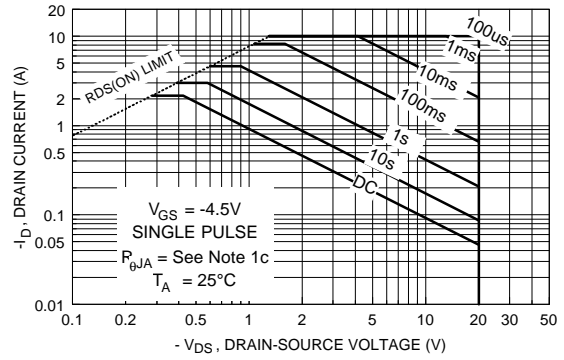

Figure 12. Switching Waveforms.

## Typical Electrical and Thermal Characteristics



**Figure 13. Transconductance Variation with Drain Current and Temperature.**



**Figure 14. Maximum Safe Operating Area.**

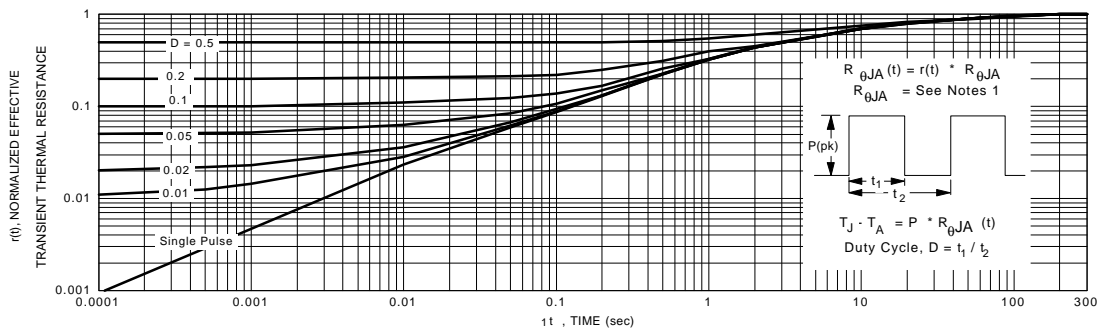

**Figure 15. Transient Thermal Response Curve.**

Note: Thermal characterization performed using the conditions described in note 1. Transient thermal response will change depending on the circuit board design.

