

NC7SP57 • NC7SP58

TinyLogic® ULP Universal Configurable 2-Input Logic Gates

General Description

The NC7SP57 and the NC7SP58 are Universal Configurable 2-Input Logic Gates from Fairchild's Ultra Low Power (ULP) Series of TinyLogic®. Ideal for applications where battery life is critical, this product is designed for ultra low power consumption within the V_{CC} operating range of 0.9V to 3.6V. Each device is capable of being configured for 1 of 5 unique 2-input logic functions. Any possible 2-input combinatorial logic function can be implemented as shown in the Function Selection Table. Device functionality is selected by how the device is wired at the board level. Figure 1 through Figure 10 illustrate how to connect the NC7SP57 and NC7SP58 respectively for the desired logic function. All inputs have been implemented with hysteresis.

The internal circuit is composed of a minimum of inverter stages including the output buffer, to enable ultra low dynamic power.

The NC7SP57 and NC7SP58, for lower drive requirements, are uniquely designed for optimized power and speed, and are fabricated with an advanced CMOS technology to achieve best in class operation while maintaining extremely low CMOS power dissipation.

Features

- 0.9V to 3.6V V_{CC} supply operation
- 3.6V overvoltage tolerant I/O's at V_{CC} from 0.9V to 3.6V
- t_{PD}
 - 5 ns typ for 3.0V to 3.6V V_{CC}
 - 6 ns typ for 2.3V to 2.7V V_{CC}
 - 8 ns typ for 1.65V to 1.95V V_{CC}
 - 10 ns typ for 1.40V to 1.60V V_{CC}
 - 14 ns typ for 1.10V to 1.30V V_{CC}
 - 40 ns typ for 0.90V V_{CC}
- Power-Off high impedance inputs and outputs
- Static Drive (I_{OH}/I_{OL})
 - ±2.6 mA @ 3.00V V_{CC}
 - ±2.1 mA @ 2.30V V_{CC}
 - ±1.5 mA @ 1.65V V_{CC}
 - ±1.0 mA @ 1.40V V_{CC}
 - ±0.5 mA @ 1.10V V_{CC}
 - ±20 μ A @ 0.9V V_{CC}
- Uses patented Quiet Series™ noise/EMI reduction circuitry
- Ultra small MicroPak™ leadfree package
- Ultra low dynamic power

Ordering Code:

Order Number	Package Number	Product Code Top Mark	Package Description	Supplied As
NC7SP57P6X	MAA06A	P57	6-Lead SC70, EIAJ SC88, 1.25mm Wide	3k Units on Tape and Reel
NC7SP57L6X	MAC06A	K9	6-Lead MicroPak, 1.0mm Wide	5k Units on Tape and Reel
NC7SP58P6X	MAA06A	P58	6-Lead SC70, EIAJ SC88, 1.25mm Wide	3k Units on Tape and Reel
NC7SP58L6X	MAC06A	L3	6-Lead MicroPak, 1.0mm Wide	5k Units on Tape and Reel

TinyLogic® is a registered trademark of Fairchild Semiconductor Corporation.
Quiet Series™ and MicroPak™ are trademarks of Fairchild Semiconductor Corporation.

Battery Life vs. V_{CC} Supply Voltage

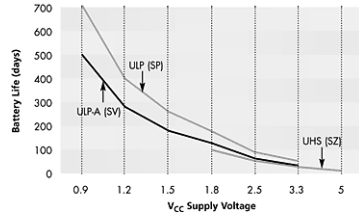

TinyLogic ULP and ULP-A with up to 50% less power consumption can extend your battery life significantly.

$$\text{Battery Life} = (V_{\text{battery}} \cdot I_{\text{battery}} \cdot 9) / (P_{\text{device}}) / 24\text{hrs/day}$$

$$\text{Where, } P_{\text{device}} = (I_{\text{CC}} \cdot V_{\text{CC}}) + (C_{\text{PD}} + C_L) \cdot V_{\text{CC}}^2 \cdot f$$

Assumes ideal 3.6V Lithium Ion battery with current rating of 900mAh and derated 90% and device frequency at 10MHz, with C_L = 15 pF load

Connection Diagrams

Pin Assignments for SC70

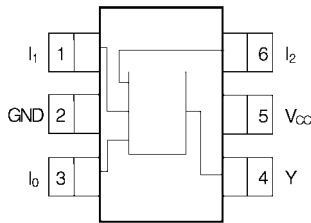

(Top View)
NC7SP57 and NC7SP58

Pin One Orientation Diagram

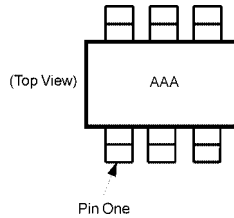

AAA = Product Code Top Mark - see ordering code

Note: Orientation of Top Mark determines Pin One location. Read the top product code mark left to right, Pin One is the lower left pin (see diagram).

Pad Assignments for MicroPak

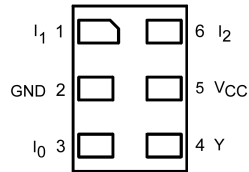

(Top Thru View)

Pin Descriptions

Pin Name	Description
I ₀ , I ₁ , I ₂	Data Input
Y	Output

Function Table

Input			NC7SP57	NC7SP58
I ₂	I ₁	I ₀	Y = (I ₀ • I ₂) + (I ₁) • (I ₂)	Y = (I ₀) • (I ₂) + (I ₁) • (I ₂)
L	L	L	H	L
L	L	H	L	H
L	H	L	H	L
L	H	H	L	H
H	L	L	L	H
H	L	H	L	H
H	H	L	H	L
H	H	H	H	L

H = HIGH Logic Level

L = LOW Logic Level

Function Selection Table

2-Input Logic Function	Device Selection	Connection Configuration
2-Input AND	NC7SP57	Figure 1
2-Input AND with inverted input	NC7SP58	Figures 7, 8
2-Input AND with both inputs inverted	NC7SP57	Figure 4
2-Input NAND	NC7SP58	Figure 6
2-Input NAND with inverted input	NC7SP57	Figures 2, 3
2-Input NAND with both inputs inverted	NC7SP58	Figure 9
2-Input OR	NC7SP58	Figure 9
2-Input OR with inverted input	NC7SP57	Figures 2, 3
2-Input OR with both inputs inverted	NC7SP58	Figure 6
2-Input NOR	NC7SP57	Figure 4
2-Input NOR with inverted input	NC7SP58	Figures 7, 8
2-Input NOR with both inputs inverted	NC7SP57	Figure 1
2-Input XOR	NC7SP58	Figure 10
2-Input XNOR	NC7SP57	Figure 5

Logic Configurations NC7SP57

Figure 1 through Figure 5 show the logical functions that can be implemented using the NC7SP57. The diagrams show the DeMorgan's equivalent logic duals for a given 2-input function. Next to the logical implementation is the board level physical implementation of how the pins of the function should be connected.

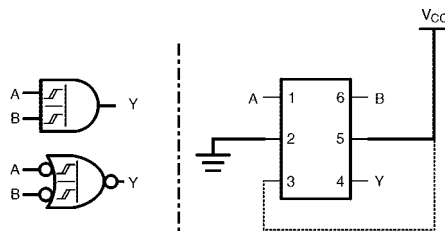

FIGURE 1. 2-Input AND Gate

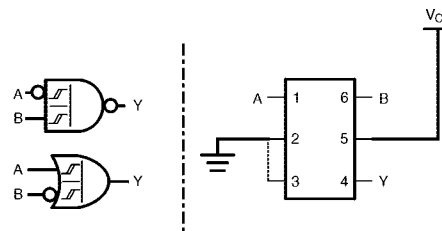

FIGURE 2. 2-Input NAND with Inverted A Input

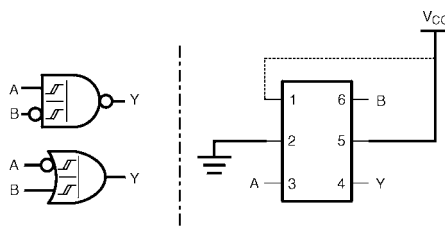

FIGURE 3. 2-Input NAND with Inverted B Input

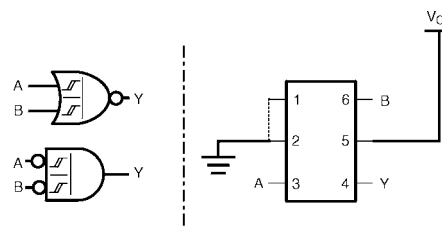

FIGURE 4. 2-Input NOR Gate

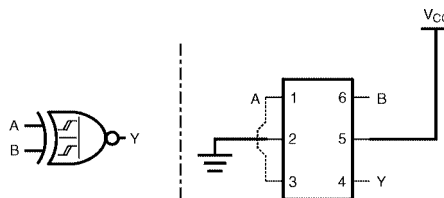

FIGURE 5. 2-Input XNOR Gate

Logic Configurations NC7SP58

Figure 6 through Figure 10 show the logical functions that can be implemented using the NC7SP58. The diagrams show the DeMorgan's equivalent logic duals for a given 2-input function. Next to the logical implementation is the board level physical implementation of how the pins of the function should be connected.

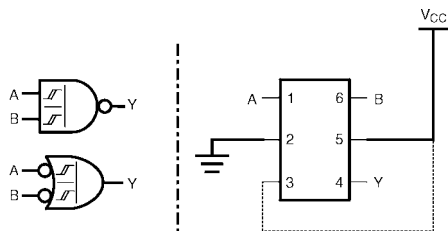

FIGURE 6. 2-Input NAND Gate

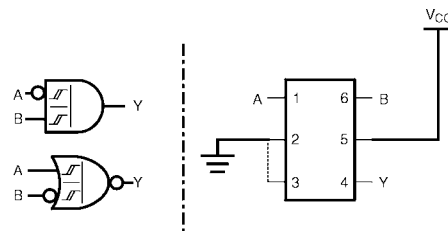

FIGURE 7. 2-Input AND with Inverted A Input

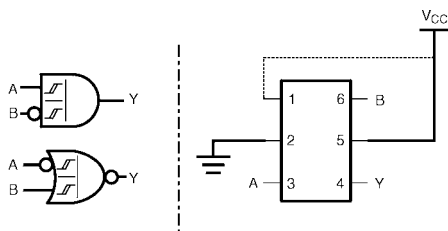

FIGURE 8. 2-Input AND with Inverted B Input

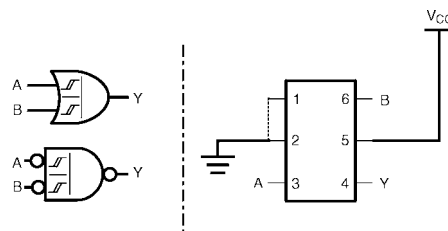

FIGURE 9. 2-Input OR Gate

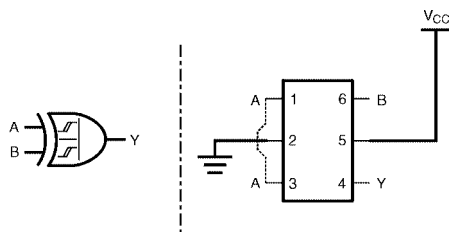

FIGURE 10. 2-Input XOR Gate

Absolute Maximum Ratings (Note 1)		Recommended Operating Conditions (Note 3)	
Supply Voltage (V_{CC})	-0.5V to +4.6V	Supply Voltage	0.9V to 3.6V
DC Input Voltage (V_{IN})	-0.5V to +4.6V	Input Voltage (V_{IN})	0V to 3.6V
DC Output Voltage (V_{OUT})		Output Voltage (V_{OUT})	
HIGH or LOW State (Note 2)	-0.5V to V_{CC} +0.5V	HIGH or LOW State	0V to V_{CC}
$V_{CC} = 0V$	-0.5V to 4.6V	$V_{CC} = 0V$	0V to 3.6V
DC Input Diode Current (I_{IK}) $V_{IN} < 0V$	±50 mA	Output Current in I_{OH}/I_{OL}	
DC Output Diode Current (I_{OK})		$V_{CC} = 3.0V$ to 3.6V	±2.6 mA
$V_{OUT} < 0V$	-50 mA	$V_{CC} = 2.3V$ to 2.7V	±2.1 mA
$V_{OUT} > V_{CC}$	+50 mA	$V_{CC} = 1.65V$ to 1.95V	±1.5 mA
DC Output Source/Sink Current (I_{OH}/I_{OL})	± 50 mA	$V_{CC} = 1.40V$ to 1.60V	± 1 mA
DC V_{CC} or Ground Current per		$V_{CC} = 1.10V$ to 1.30V	±0.5 mA
Supply Pin (I_{CC} or Ground)	± 50 mA	$V_{CC} = 0.9V$	±20 μA
Storage Temperature Range (T_{STG})	-65°C to +150°C	Free Air Operating Temperature (T_A)	-40°C to +85°C
		Minimum Input Edge Rate ($\Delta t/\Delta V$)	
		$V_{IN} = 0.8V$ to 2.0V, $V_{CC} = 3.0V$	10 ns/V

Note 1: Absolute Maximum Ratings: are those values beyond which the safety of the device cannot be guaranteed. The device should not be operated at these limits. The parametric values defined in the Electrical Characteristics tables are not guaranteed at the absolute maximum ratings. The "Recommended Operating Conditions" table will define the conditions for actual device operation.

Note 2: I_O Absolute Maximum Rating must be observed.

Note 3: Unused inputs must be held HIGH or LOW. They may not float.

DC Electrical Characteristics

Symbol	Parameter	V_{CC} (V)	$T_A = +25^\circ C$		$T_A = -40^\circ C$ to $+85^\circ C$		Units	Conditions
			Min	Max	Min	Max		
V_P	Positive Threshold Voltage	0.90	0.3	0.6	0.3	0.6	V	
		1.10	0.4	1.0	0.4	1.0		
		1.40	0.5	1.2	0.5	1.2		
		1.65	0.7	1.5	0.7	1.5		
		2.30	1.0	1.9	1.0	1.9		
V_N	Negative Threshold Voltage	0.90	0.10	0.6	0.10	0.6	V	
		1.10	0.15	0.7	0.15	0.7		
		1.40	0.20	0.8	0.20	0.8		
		1.65	0.25	0.9	0.25	0.9		
		2.30	0.4	1.15	0.4	1.15		
V_H	Hysteresis Voltage	0.90	0.07	0.5	0.07	0.5	V	
		1.10	0.08	0.6	0.08	0.6		
		1.40	0.09	0.8	0.09	0.8		
		1.65	0.10	1.0	0.10	1.0		
		2.30	0.25	1.1	0.25	1.1		
		3.0	0.60	1.8	0.60	1.8		

DC Electrical Characteristics (Continued)

Symbol	Parameter	V _{CC} (V)	T _A = +25°C		T _A = -40°C to +85°C		Units	Conditions	
			Min	Max	Min	Max			
V _{OH}	HIGH Level Output Voltage	0.90	V _{CC} - 0.1		V _{CC} - 0.1		V	I _{OH} = -20 μA	
		1.10 ≤ V _{CC} ≤ 1.30	V _{CC} - 0.1		V _{CC} - 0.1				
		1.40 ≤ V _{CC} ≤ 1.60	V _{CC} - 0.1		V _{CC} - 0.1				
		1.65 ≤ V _{CC} ≤ 1.95	V _{CC} - 0.1		V _{CC} - 0.1				
		2.30 ≤ V _{CC} ≤ 2.70	V _{CC} - 0.1		V _{CC} - 0.1				
		3.00 ≤ V _{CC} ≤ 3.60	V _{CC} - 0.1		V _{CC} - 0.1				
		1.10 ≤ V _{CC} ≤ 1.30	0.75 x V _{CC}		0.70 x V _{CC}				
		1.40 ≤ V _{CC} ≤ 1.60	1.07		0.99				
		1.65 ≤ V _{CC} ≤ 1.95	1.24		1.22				
		2.30 ≤ V _{CC} ≤ 2.70	1.95		1.87				
3.00 ≤ V _{CC} ≤ 3.60	2.61		2.55						
V _{OL}	LOW Level Output Voltage	0.90		0.1		0.1	V	I _{OL} = 20 μA	
		1.10 ≤ V _{CC} ≤ 1.30		0.1		0.1			
		1.40 ≤ V _{CC} ≤ 1.60		0.1		0.1			
		1.65 ≤ V _{CC} ≤ 1.95		0.1		0.1			
		2.30 ≤ V _{CC} ≤ 2.70		0.1		0.1			
		3.00 ≤ V _{CC} ≤ 3.60		0.1		0.1			
		1.10 ≤ V _{CC} ≤ 1.30		0.30 x V _{CC}		0.30 x V _{CC}			
		1.40 ≤ V _{CC} ≤ 1.60		0.31		0.37			
		1.65 ≤ V _{CC} ≤ 1.95		0.31		0.35			
		2.30 ≤ V _{CC} ≤ 2.70		0.31		0.33			
3.00 ≤ V _{CC} ≤ 3.60		0.31		0.33					
I _{IN}	Input Leakage Current	0.90 to 3.60		±0.1		±0.9	μA	0 ≤ V _I ≤ 3.6V	
I _{OFF}	Power Off Leakage Current	0		1		5	μA	0 ≤ (V _I , V _O) ≤ 3.6V	
I _{CC}	Quiescent Supply Current	0.90 to 3.60		0.5		5.0	μA	V _I = V _{CC} or GND	

AC Electrical Characteristics

Symbol	Parameter	V _{CC} (V)	T _A = +25°C			T _A = -40°C to +85°C		Units	Conditions	Figure Number
			Min	Typ	Max	Min	Max			
t _{PHL} , t _{PLH}	Propagation Delay	0.90		40				ns	C _L = 10 pF R _L = 1 MΩ	Figures 11, 12
		1.10 ≤ V _{CC} ≤ 1.30	5.5	14	28.0	5.0	51.0			
		1.40 ≤ V _{CC} ≤ 1.60	4.5	10	17.0	4.0	21.0			
		1.65 ≤ V _{CC} ≤ 1.95	3.5	8	14.0	3.0	17.0			
		2.30 ≤ V _{CC} ≤ 2.70	2.5	6	10.0	2.0	13.0			
3.00 ≤ V _{CC} ≤ 3.60	1.5	5	8.0	1.0	12.0					
t _{PHL} , t _{PLH}	Propagation Delay	0.90		41				ns	C _L = 15 pF R _L = 1 MΩ	Figures 11, 12
		1.10 ≤ V _{CC} ≤ 1.30	6.5	15	29.0	6.0	52.0			
		1.40 ≤ V _{CC} ≤ 1.60	5.0	10	18.0	4.5	22.0			
		1.65 ≤ V _{CC} ≤ 1.95	4.0	8	15.0	3.5	18.0			
		2.30 ≤ V _{CC} ≤ 2.70	3.0	6	11.0	2.5	14.0			
3.00 ≤ V _{CC} ≤ 3.60	2.0	5	9.0	1.5	12.0					
t _{PHL} , t _{PLH}	Propagation Delay	0.90		46				ns	C _L = 30 pF R _L = 1 MΩ	Figures 11, 12
		1.10 ≤ V _{CC} ≤ 1.30	7.0	17	32.0	6.5	55.0			
		1.40 ≤ V _{CC} ≤ 1.60	5.5	11	20.0	5.0	24.0			
		1.65 ≤ V _{CC} ≤ 1.95	4.5	9	17.0	4.0	20.0			
		2.30 ≤ V _{CC} ≤ 2.70	3.5	7	12.0	3.0	15.0			
3.00 ≤ V _{CC} ≤ 3.60	2.5	6	11.0	2.0	14.0					
C _{IN}	Input Capacitance	0		2.0			pF			
C _{OUT}	Output Capacitance	0		4.0			pF			
C _{PD}	Power Dissipation Capacitance	0.9 to 3.60		8			pF	V _I = 0V or V _{CC} , f = 10 MHz		

AC Loading and Waveforms

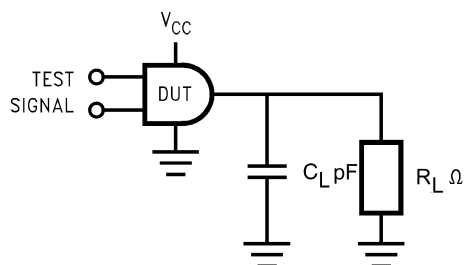

FIGURE 11. AC Test Circuit

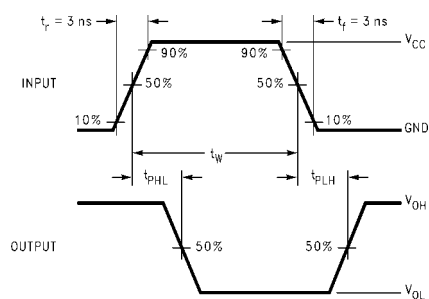

FIGURE 12. AC Waveforms

Symbol	V_{CC}					
	3.3V ± 0.3V	2.5V ± 0.2V	1.8V ± 0.15V	1.5V ± 0.10V	1.2V ± 0.10V	0.9V
V_{mi}	1.5V	$V_{CC}/2$	$V_{CC}/2$	$V_{CC}/2$	$V_{CC}/2$	$V_{CC}/2$
V_{mo}	1.5V	$V_{CC}/2$	$V_{CC}/2$	$V_{CC}/2$	$V_{CC}/2$	$V_{CC}/2$

Tape and Reel Specification

TAPE FORMAT for SC70

Package Designator	Tape Section	Number Cavities	Cavity Status	Cover Tape Status
P6X	Leader (Start End)	125 (typ)	Empty	Sealed
	Carrier	3000	Filled	Sealed
	Trailer (Hub End)	75 (typ)	Empty	Sealed

TAPE DIMENSIONS inches (millimeters)

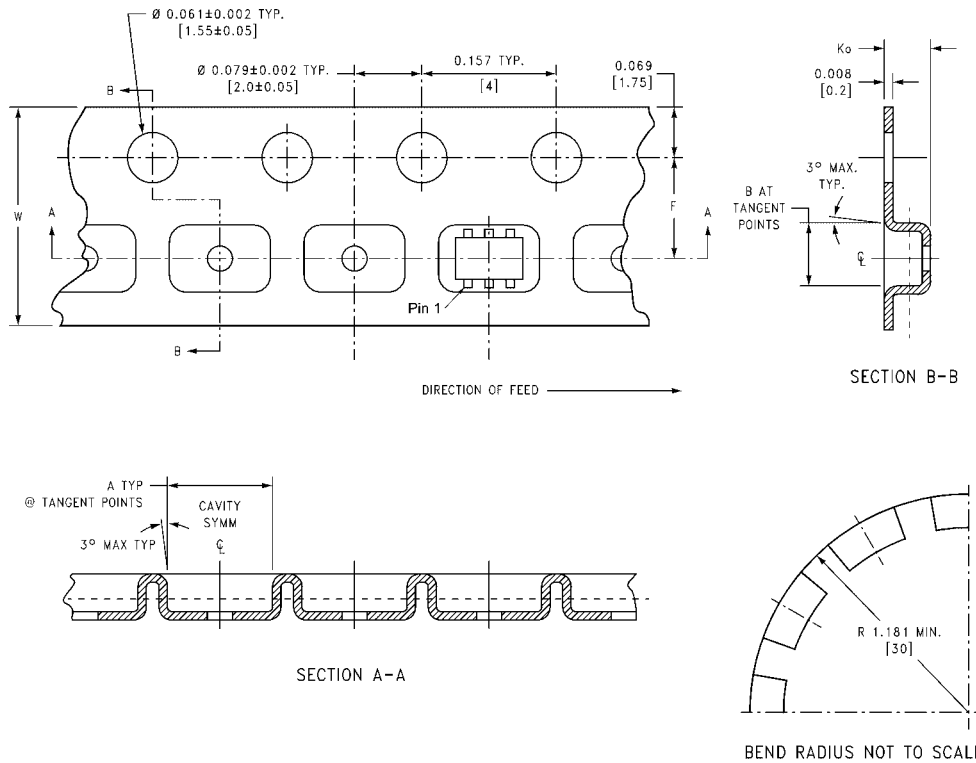

Package	Tape Size	DIM A	DIM B	DIM F	DIM K _o	DIM P1	DIM W
SC70-6	8 mm	0.093 (2.35)	0.096 (2.45)	0.138 ± 0.004 (3.5 ± 0.10)	0.053 ± 0.004 (1.35 ± 0.10)	0.157 (4)	0.315 ± 0.004 (8 ± 0.1)

Tape and Reel Specification (Continued)								
TAPE FORMAT for MicroPak								
Package Designator	Tape Section				Number Cavities	Cavity Status	Cover Tape Status	
L6X	Leader (Start End)				125 (typ)	Empty	Sealed	
	Carrier				5000	Filled	Sealed	
	Trailer (Hub End)				75 (typ)	Empty	Sealed	

SECTION A-A
SCALE: 10X

SECTION B-B
SCALE: 10X

SECTION A-A
SCALE: 10X

REEL DIMENSIONS inches (millimeters)

DETAIL X

DETAIL X
SCALE: 3X

Tape Size	A	B	C	D	N	W1	W2	W3
8 mm	7.0 (177.8)	0.059 (1.50)	0.512 (13.00)	0.795 (20.20)	2.165 (55.00)	0.331 + 0.059/-0.000 (8.40 + 1.50/-0.00)	0.567 (14.40)	W1 + 0.078/-0.039 (W1 + 2.00/-1.00)

Physical Dimensions inches (millimeters) unless otherwise noted

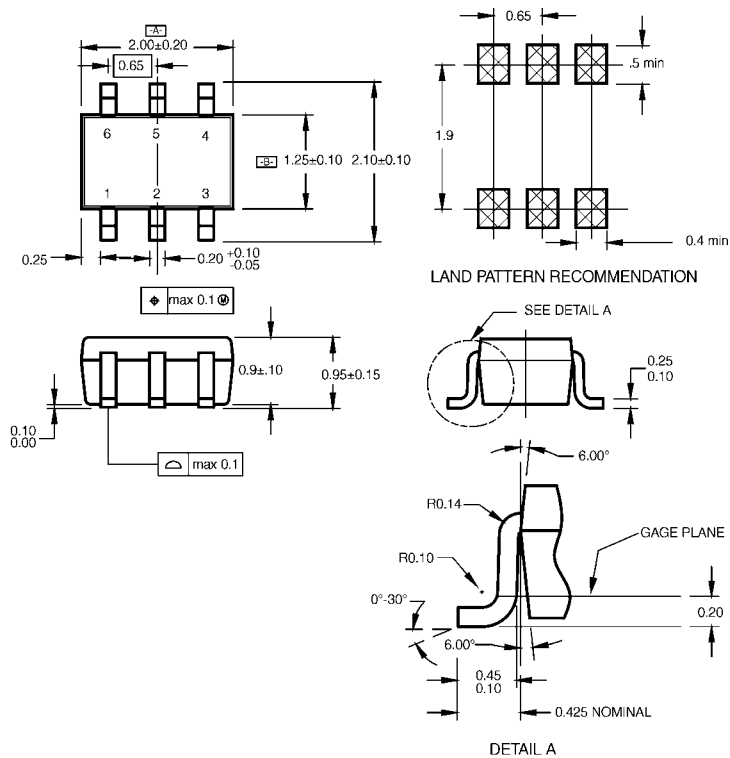

NOTES:

- A. CONFORMS TO EIAJ REGISTERED OUTLINE DRAWING SC88.
- B. DIMENSIONS DO NOT INCLUDE BURRS OR MOLD FLASH.
- C. DIMENSIONS ARE IN MILLIMETERS.

MAA06ARevC

**6-Lead SC70, EIAJ SC88, 1.25mm Wide
Package Number MAA06A**

Physical Dimensions inches (millimeters) unless otherwise noted (Continued)

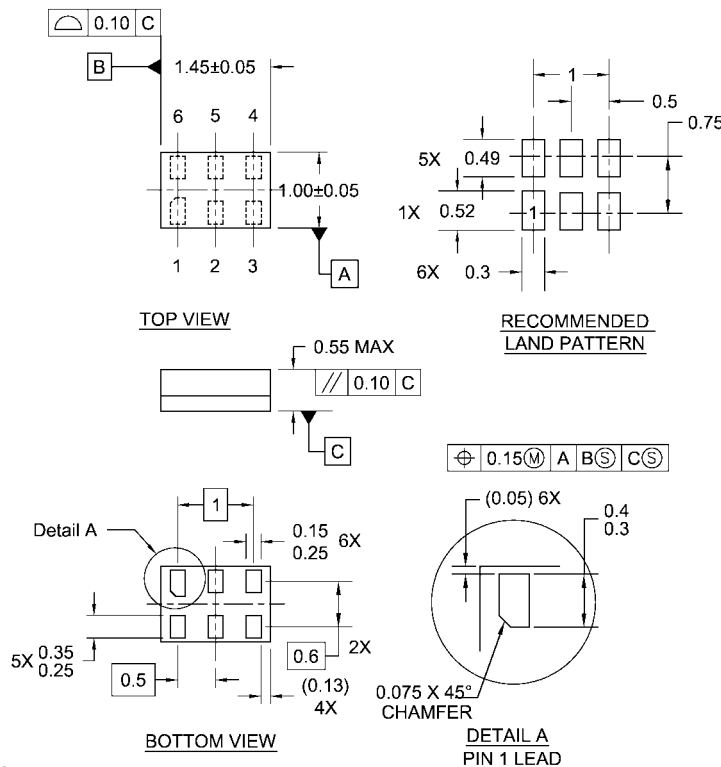

- Notes:
1. JEDEC PACKAGE REGISTRATION IS ANTICIPATED
 2. DIMENSIONS ARE IN MILLIMETERS
 3. DRAWING CONFORMS TO ASME Y14.5M-1994

MAC06ARevB

**6-Lead MicroPak, 1.0mm Wide
Package Number MAC06A**

Fairchild does not assume any responsibility for use of any circuitry described, no circuit patent licenses are implied and Fairchild reserves the right at any time without notice to change said circuitry and specifications.

LIFE SUPPORT POLICY

FAIRCHILD'S PRODUCTS ARE NOT AUTHORIZED FOR USE AS CRITICAL COMPONENTS IN LIFE SUPPORT DEVICES OR SYSTEMS WITHOUT THE EXPRESS WRITTEN APPROVAL OF THE PRESIDENT OF FAIRCHILD SEMICONDUCTOR CORPORATION. As used herein:

1. Life support devices or systems are devices or systems which, (a) are intended for surgical implant into the body, or (b) support or sustain life, and (c) whose failure to perform when properly used in accordance with instructions for use provided in the labeling, can be reasonably expected to result in a significant injury to the user.
2. A critical component in any component of a life support device or system whose failure to perform can be reasonably expected to cause the failure of the life support device or system, or to affect its safety or effectiveness.

www.fairchildsemi.com