

8A, 400V - 600V Ultrafast Diodes

The MUR840, MUR860, RURP840 and RURP860 are low forward voltage drop ultrafast recovery rectifiers ($t_{rr} < 60\text{ns}$). They use a glass-passivated ion-implanted, epitaxial construction.

These devices are intended for use as output rectifiers and flywheel diodes in a variety of high-frequency pulse-width modulated switching regulators. Their low stored charge and attendant fast reverse-recovery behavior minimize electrical noise generation and in many circuits markedly reduce the turn-on dissipation of the associated power switching transistors.

Formerly developmental type TA09616.

Ordering Information

PART NUMBER	PACKAGE	BRAND
MUR840	TO-220AC	MUR840
RURP840	TO-220AC	RURP840
MUR860	TO-220AC	MUR860
RURP860	TO-220AC	RURP860

NOTE: When ordering, use the entire part number.

Symbol



Features

- Ultrafast with Soft Recovery <60ns
- Operating Temperature 175°C
- Reverse Voltage 600V
- Avalanche Energy Rated
- Planar Construction

Applications

- Switching Power Supplies
- Power Switching Circuits
- General Purpose

Packaging

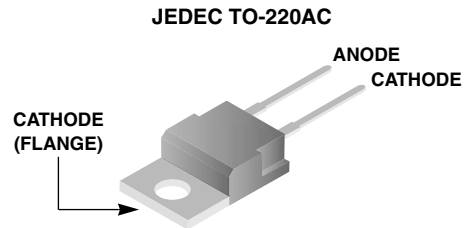

Absolute Maximum Ratings $T_C = 25^\circ\text{C}$, Unless Otherwise Specified

	MUR840 RURP840	MUR860 RURP860	UNITS
Peak Repetitive Reverse Voltage V_{RRM}	400	600	V
Working Peak Reverse Voltage V_{RWM}	400	600	V
DC Blocking Voltage V_R	400	600	V
Average Rectified Forward Current $I_{F(AV)}$ ($T_C = 155^\circ\text{C}$)	8	8	A
Repetitive Peak Surge Current I_{FRM} (Square Wave, 20kHz)	16	16	A
Nonrepetitive Peak Surge Current I_{FSM} (Halfwave, 1 Phase, 60Hz)	100	100	A
Maximum Power Dissipation P_D	75	75	W
Avalanche Energy (See Figures 10 and 11) E_{AVL}	20	20	mJ
Operating and Storage Temperature T_{STG}, T_J	-65 to 175	-65 to 175	°C
Maximum Lead Temperature for Soldering			
Leads at 0.063 in. (1.6mm) from case for 10s T_L	300	300	°C
Package Body for 10s, see Tech Brief 334. T_{PKG}	260	260	°C

MUR840, MUR860, RURP840, RURP860

Electrical Specifications $T_C = 25^\circ\text{C}$, Unless Otherwise Specified

SYMBOL	TEST CONDITION	MUR840, RURP840			MUR860, RURP860			UNITS
		MIN	TYP	MAX	MIN	TYP	MAX	
V_F	$I_F = 8\text{A}$	-	-	1.3	-	-	1.5	V
	$I_F = 8\text{A}, T_C = 150^\circ\text{C}$	-	-	1.0	-	-	1.2	V
I_R	$V_R = 400\text{V}$	-	-	100	-	-	-	μA
	$V_R = 600\text{V}$	-	-	-	-	-	100	μA
	$V_R = 400\text{V}, T_C = 150^\circ\text{C}$	-	-	500	-	-	-	μA
	$V_R = 600\text{V}, T_C = 150^\circ\text{C}$	-	-	-	-	-	500	μA
t_{rr}	$I_F = 1\text{A}, dI_F/dt = 200\text{A}/\mu\text{s}$	-	-	60	-	-	60	ns
	$I_F = 8\text{A}, dI_F/dt = 200\text{A}/\mu\text{s}$	-	-	70	-	-	70	ns
t_a	$I_F = 8\text{A}, dI_F/dt = 200\text{A}/\mu\text{s}$	-	32	-	-	32	-	ns
t_b	$I_F = 8\text{A}, dI_F/dt = 200\text{A}/\mu\text{s}$	-	21	-	-	21	-	ns
Q_{RR}	$I_F = 8\text{A}, dI_F/dt = 200\text{A}/\mu\text{s}$	-	195	-	-	195	-	nC
C_J	$V_R = 10\text{V}, I_F = 0\text{A}$	-	25	-	-	25	-	pF
$R_{\theta JC}$		-	-	2	-	-	2	$^\circ\text{C}/\text{W}$

DEFINITIONS

V_F = Instantaneous forward voltage ($p_w = 300\mu\text{s}$, $D = 2\%$).

I_R = Instantaneous reverse current.

t_{rr} = Reverse recovery time (See Figure 9), summation of $t_a + t_b$.

t_a = Time to reach peak reverse current (See Figure 9).

t_b = Time from peak I_{RM} to projected zero crossing of I_{RM} based on a straight line from peak I_{RM} through 25% of I_{RM} (See Figure 9).

Q_{RR} = Reverse recovery charge.

C_J = Junction Capacitance.

$R_{\theta JC}$ = Thermal resistance junction to case.

p_w = pulse width.

D = duty cycle.

Typical Performance Curves

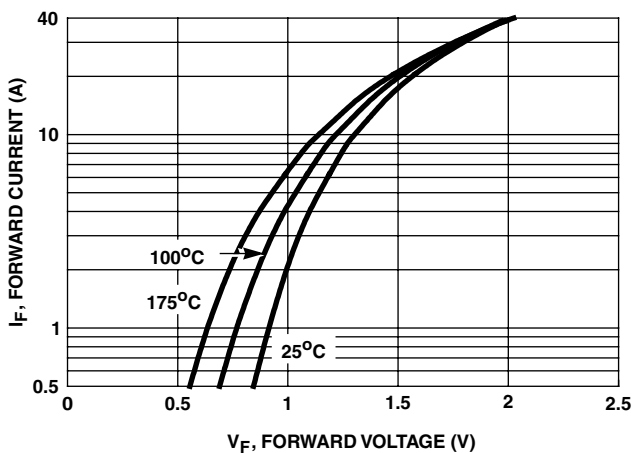

FIGURE 1. FORWARD CURRENT vs FORWARD VOLTAGE

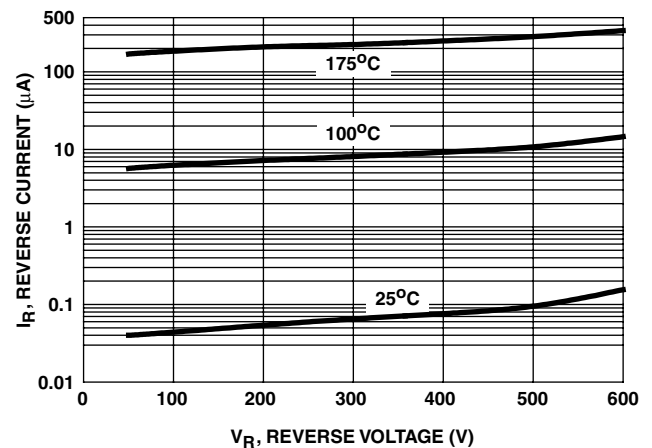

FIGURE 2. REVERSE CURRENT vs REVERSE VOLTAGE

Typical Performance Curves (Continued)

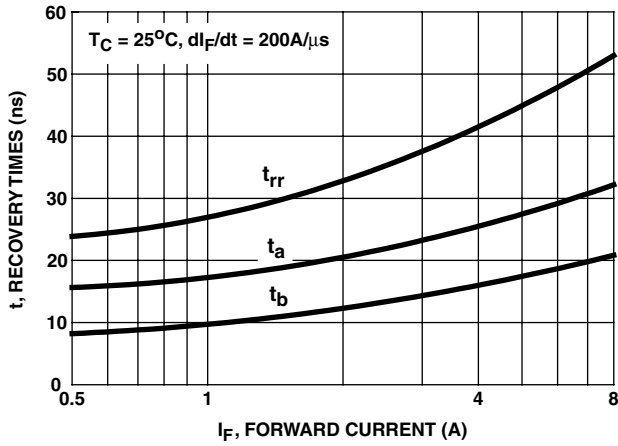

FIGURE 3. t_{rr} , t_a AND t_b CURVES vs FORWARD CURRENT

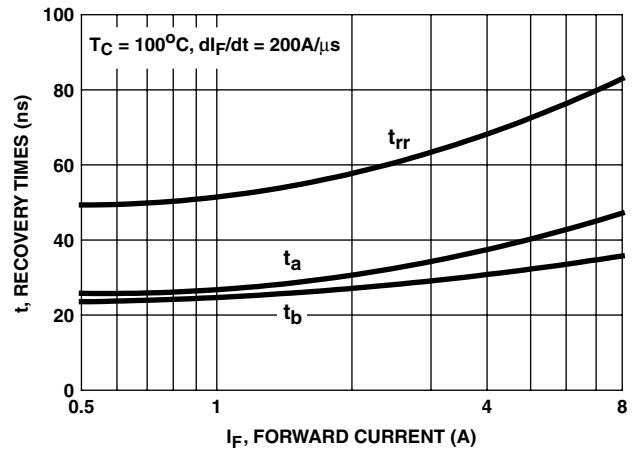

FIGURE 4. t_{rr} , t_a AND t_b CURVES vs FORWARD CURRENT

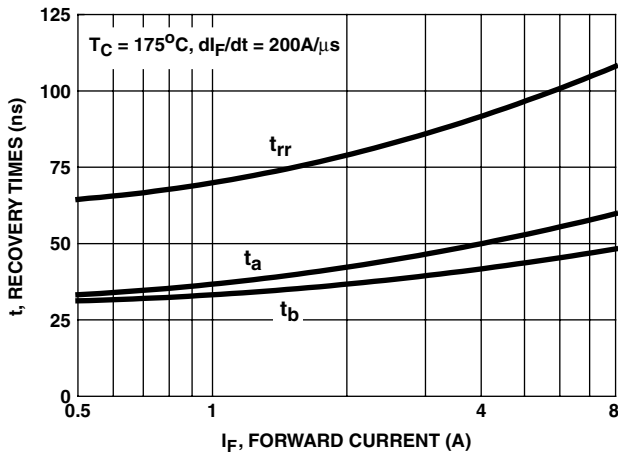

FIGURE 5. t_{rr} , t_a AND t_b CURVES vs FORWARD CURRENT

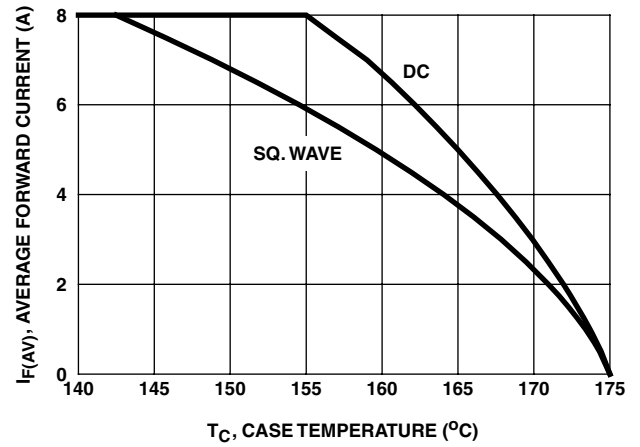

FIGURE 6. CURRENT DERATING CURVE

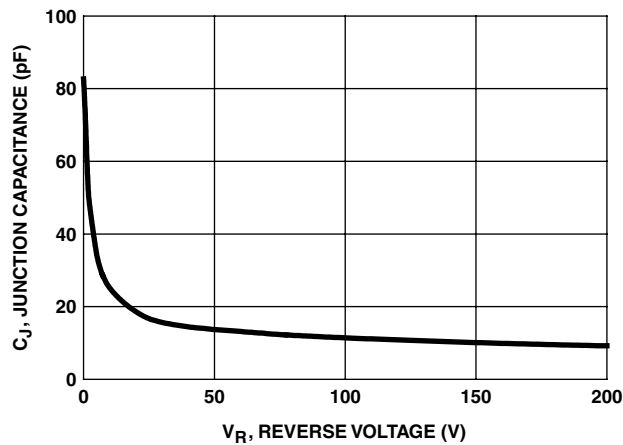

FIGURE 7. JUNCTION CAPACITANCE vs REVERSE VOLTAGE

Test Circuits and Waveforms

V_{GE} AMPLITUDE AND
 R_G CONTROL di_F/dt
 t_1 AND t_2 CONTROL I_F

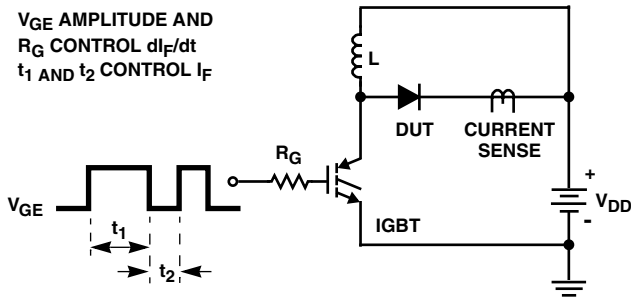

FIGURE 8. t_{rr} TEST CIRCUIT

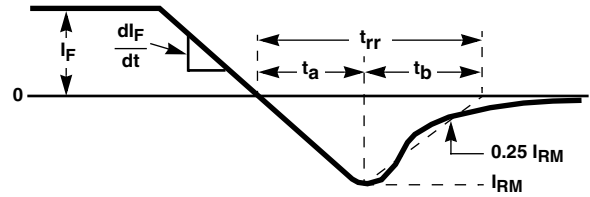

FIGURE 9. t_{rr} WAVEFORMS AND DEFINITIONS

$I = 1A$
 $L = 40mH$
 $R < 0.1\Omega$
 $E_{AVL} = 1/2LI^2 [V_{R(AVL)}/(V_{R(AVL)} - V_{DD})]$
 $Q_1 = IGBT (BV_{CES} > DUT V_{R(AVL)})$

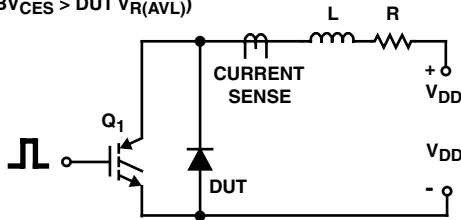

FIGURE 10. AVALANCHE ENERGY TEST CIRCUIT

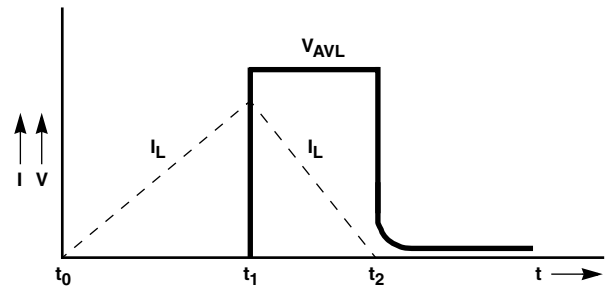

FIGURE 11. AVALANCHE CURRENT AND VOLTAGE WAVEFORMS

TRADEMARKS

The following are registered and unregistered trademarks Fairchild Semiconductor owns or is authorized to use and is not intended to be an exhaustive list of all such trademarks.

ACE _x TM	FAST [®]	OPTOLOGIC TM	SMART START TM	VCX TM
Bottomless TM	FAST _r TM	OPTOPLANAR TM	STAR*POWER TM	
CoolFET TM	FRFET TM	PACMAN TM	Stealth TM	
CROSSVOLT TM	GlobalOptoisolator TM	POP TM	SuperSOT TM -3	
DenseTrench TM	GTO TM	Power247 TM	SuperSOT TM -6	
DOMET TM	HiSeC TM	PowerTrench [®]	SuperSOT TM -8	
EcoSPARK TM	ISOPLANAR TM	QFET TM	SyncFET TM	
E ² CMOS TM	LittleFET TM	QS TM	TinyLogic TM	
EnSigna TM	MicroFET TM	QT Optoelectronics TM	TruTranslation TM	
FACT TM	MicroPak TM	Quiet Series TM	UHC TM	
FACT Quiet Series TM	MICROWIRE TM	SILENT SWITCHER [®]	UltraFET [®]	

STAR*POWER is used under license

DISCLAIMER

FAIRCHILD SEMICONDUCTOR RESERVES THE RIGHT TO MAKE CHANGES WITHOUT FURTHER NOTICE TO ANY PRODUCTS HEREIN TO IMPROVE RELIABILITY, FUNCTION OR DESIGN. FAIRCHILD DOES NOT ASSUME ANY LIABILITY ARISING OUT OF THE APPLICATION OR USE OF ANY PRODUCT OR CIRCUIT DESCRIBED HEREIN; NEITHER DOES IT CONVEY ANY LICENSE UNDER ITS PATENT RIGHTS, NOR THE RIGHTS OF OTHERS.

LIFE SUPPORT POLICY

FAIRCHILD'S PRODUCTS ARE NOT AUTHORIZED FOR USE AS CRITICAL COMPONENTS IN LIFE SUPPORT DEVICES OR SYSTEMS WITHOUT THE EXPRESS WRITTEN APPROVAL OF FAIRCHILD SEMICONDUCTOR CORPORATION.

As used herein:

1. Life support devices or systems are devices or systems which, (a) are intended for surgical implant into the body, or (b) support or sustain life, or (c) whose failure to perform when properly used in accordance with instructions for use provided in the labeling, can be reasonably expected to result in significant injury to the user.
2. A critical component is any component of a life support device or system whose failure to perform can be reasonably expected to cause the failure of the life support device or system, or to affect its safety or effectiveness.

PRODUCT STATUS DEFINITIONS

Definition of Terms

Datasheet Identification	Product Status	Definition
Advance Information	Formative or In Design	This datasheet contains the design specifications for product development. Specifications may change in any manner without notice.
Preliminary	First Production	This datasheet contains preliminary data, and supplementary data will be published at a later date. Fairchild Semiconductor reserves the right to make changes at any time without notice in order to improve design.
No Identification Needed	Full Production	This datasheet contains final specifications. Fairchild Semiconductor reserves the right to make changes at any time without notice in order to improve design.
Obsolete	Not In Production	This datasheet contains specifications on a product that has been discontinued by Fairchild semiconductor. The datasheet is printed for reference information only.