

PACKAGE DIMENSIONS

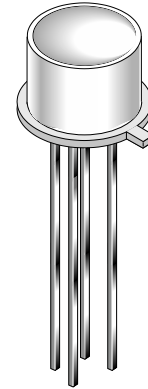

SCHEMATIC

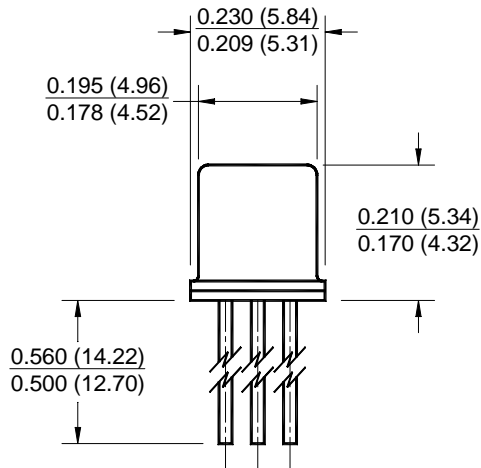
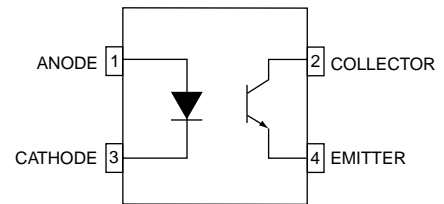

NOTES:

1. Dimensions for all drawings are in inches (mm).
2. Tolerance of $\pm .010$ (.25) on all non-nominal dimensions unless otherwise specified.

DESCRIPTION

The MCT4 is a standard four-lead, TO-18 package containing a GaAs infrared emitting diode optically coupled to an NPN silicon planar phototransistor.

FEATURES

- Hermetically package
- High current transfer ratio; typically 35%
- High isolation resistance; 10^{11} ohms at 500 volts
- High voltage isolation emitter to detector

ABSOLUTE MAXIMUM RATINGS ($T_A = 25^\circ\text{C}$ unless otherwise specified)			
Parameter	Symbol	Rating	Unit
Operating Temperature	T_{OPR}	-55 to +125	$^\circ\text{C}$
Storage Temperature	T_{STG}	-65 to +150	$^\circ\text{C}$
Soldering Temperature (Flow)	T_{SOL-F}	260 for 10 sec	$^\circ\text{C}$
EMITTER			
Power Dissipation at 25 $^\circ\text{C}$ Ambient (1)	P_D	90	mW
Continuous Forward Current	I_F	40	mA
Reverse Voltage	V_R	3	V
Forward Current - Peak (1 μs pulse, 300 pps)	$I_F(pk)$	3.0	A
DETECTOR			
Power Dissipation 25 $^\circ\text{C}$ Ambient (2)	P_D	200	mW
Collector to Emitter Voltage	V_{CEO}	30	V
Emitter to Collector Voltage	V_{ECO}	7	V
COUPLER			
Total Power Dissipation (3)	P_D	250	mW
Isolation Voltage		1000	VDC

ELECTRICAL / OPTICAL CHARACTERISTICS ($T_A = 25^\circ\text{C}$)						
INDIVIDUAL COMPONENT CHARACTERISTICS						
Parameters	Test Conditions	Symbol	Min	Typ	Max	Units
EMITTER						
Forward Voltage	$I_F = 40\text{ mA}$	V_F		1.30	1.50	V
Reverse Current	$V_R = 3.0\text{ V}$	I_R		0.15	10	μA
Capacitance	$V = 0\text{ V}$	C		150		pF
DETECTOR						
Breakdown Voltage Collector to Emitter	$I_C = 1.0\text{ mA}, I_F = 0$	BV_{CEO}	30			V
Emitter to Collector	$I_E = 100\ \mu\text{A}, I_F = 0$	BV_{ECO}	7	12		V
Leakage Current Collector to Emitter	$V_{CE} = 10\text{ V}, I_F = 0$	I_{CEO}		5	50	nA
Capacitance Collector to Emitter	$V_{CE} = 0$	C_{CE}		2		pF

NOTE:

1. Derate power linearly 1.2 mW/ $^\circ\text{C}$ above 25 $^\circ\text{C}$
2. Derate power linearly 2.67 mW/ $^\circ\text{C}$ above 25 $^\circ\text{C}$
3. Derate power linearly 3.3 mW/ $^\circ\text{C}$ above 25 $^\circ\text{C}$

MCT4

TRANSFER CHARACTERISTICS ($T_A = 25^\circ\text{C}$ Unless otherwise specified.)						
DC Characteristics	Test Conditions	Symbol	Min	Typ	Max	Units
COUPLED						
DC current Transfer Ratio (note 1)	$V_{CE} = 10\text{ V}, I_F = 10\text{ mA}$	CTR	15	35		%
Saturation Voltage	$I_C = 500\ \mu\text{A}, I_F = 10\text{ mA}$	$V_{CE(SAT)}$		0.1		V
	$I_C = 2\text{ mA}, I_F = 50\text{ mA}$			0.2	0.5	
AC Characteristics	Test Conditions	Symbol	Min	Typ	Max	Units
Capacitance LED to Detector				1.8		pF
Bandwidth (Fig. 5)	Note 2			300		kHz
Rise Time and Fall Time (see operating schematic)	$I_C = 2\text{ mA}, V_{CE} = 10\text{ V}, \text{Note 3}$			2		μs

ISOLATION CHARACTERISTICS						
Characteristic	Test Conditions	Symbol	Min	Typ	Max	Units
Isolation Resistance	$V = 500\text{ VDC}$	R_{ISO}	10^{11}	10^{12}		Ω
Breakdown Voltage	Time = 1 sec		1000	1500		VDC

NOTE:

1. The current transfer ratio (I_C/I_F) is the ratio of the detector collector current to the LED input current with V_{CE} at 10 volts.
2. The frequency at which i_c is 3 dB down from the 1 kHz value.
3. Rise time (t_r) is the time required for the collector current to increase from 10% of its final value, to 90%. Fall time (t_f) is the time required for the collector current to decrease from 90% of its initial value to 10%.

Figure 1. Detector Output Characteristics

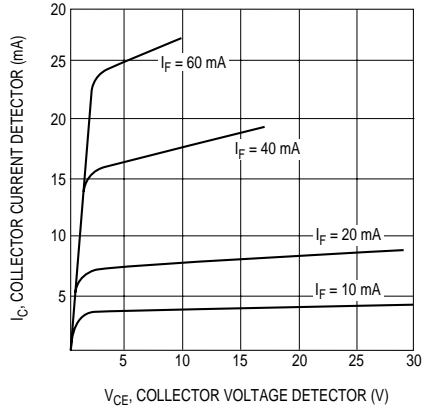

Figure 2. Input Current vs. Output Current

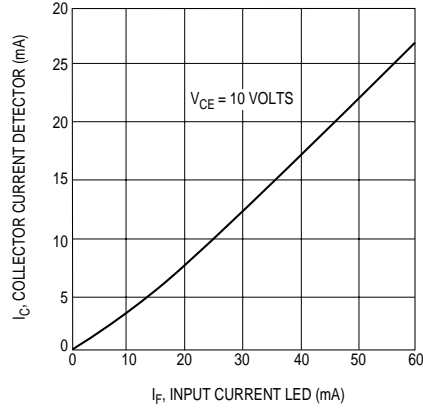

Figure 3. Dark Current vs. Temperature

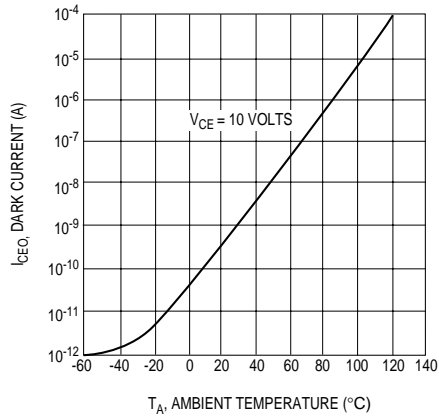

Figure 4. Current Output vs. Temperature

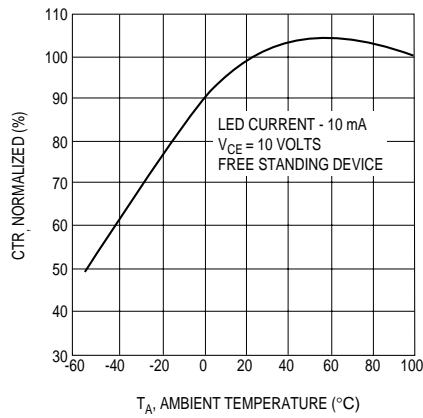

Figure 5. Output vs. Frequency

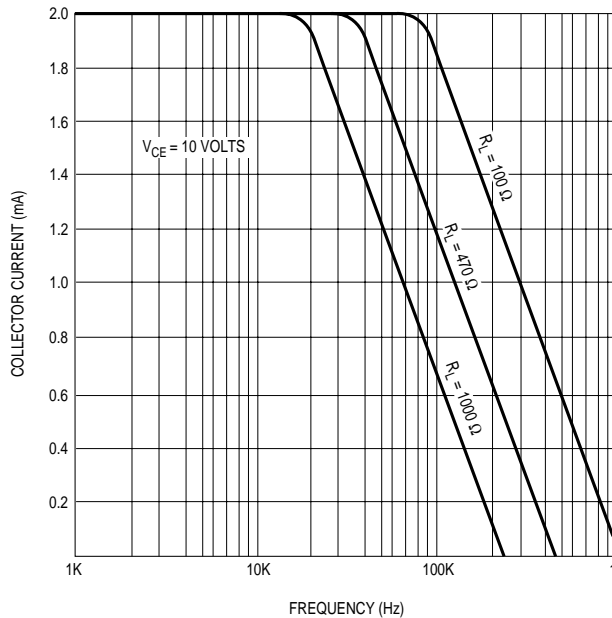
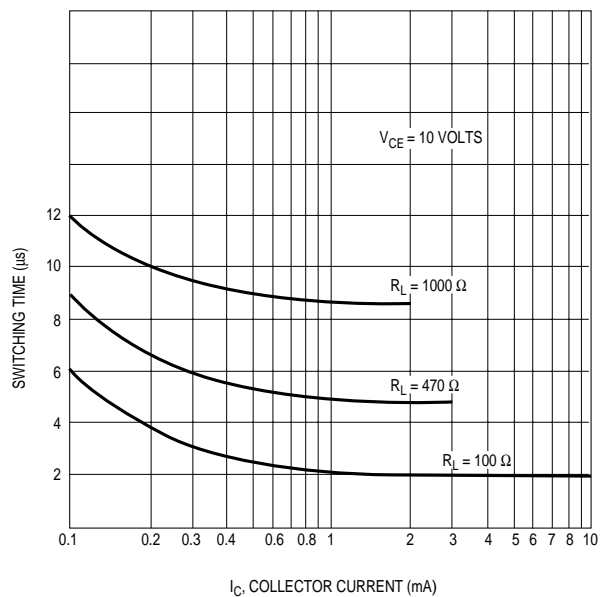

Figure 6. Switching Time vs. Collector Current



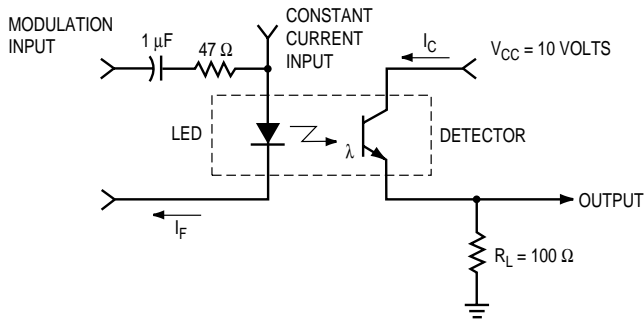

Figure 7. Modulation Circuit Used to Obtain Output vs. Frequency Plot

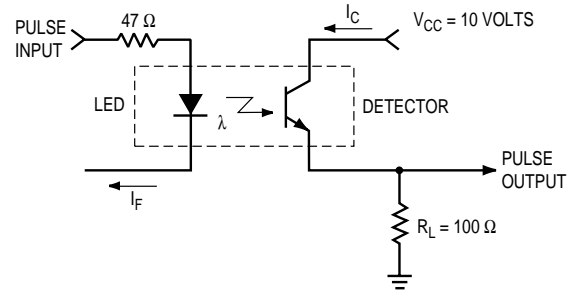

Figure 8. Circuit Used to Obtain Switching Time vs. Collector Current Plot

DISCLAIMER

FAIRCHILD SEMICONDUCTOR RESERVES THE RIGHT TO MAKE CHANGES WITHOUT FURTHER NOTICE TO ANY PRODUCTS HEREIN TO IMPROVE RELIABILITY, FUNCTION OR DESIGN. FAIRCHILD DOES NOT ASSUME ANY LIABILITY ARISING OUT OF THE APPLICATION OR USE OF ANY PRODUCT OR CIRCUIT DESCRIBED HEREIN; NEITHER DOES IT CONVEY ANY LICENSE UNDER ITS PATENT RIGHTS, NOR THE RIGHTS OF OTHERS.

LIFE SUPPORT POLICY

FAIRCHILD'S PRODUCTS ARE NOT AUTHORIZED FOR USE AS CRITICAL COMPONENTS IN LIFE SUPPORT DEVICES OR SYSTEMS WITHOUT THE EXPRESS WRITTEN APPROVAL OF THE PRESIDENT OF FAIRCHILD SEMICONDUCTOR CORPORATION. As used herein:

1. Life support devices or systems are devices or systems which, (a) are intended for surgical implant into the body, or (b) support or sustain life, and (c) whose failure to perform when properly used in accordance with instructions for use provided in labeling, can be reasonably expected to result in a significant injury of the user.
2. A critical component in any component of a life support device or system whose failure to perform can be reasonably expected to cause the failure of the life support device or system, or to affect its safety or effectiveness.