

H11AV1-M

H11AV1A-M

H11AV2-M

H11AV2A-M

PACKAGE OUTLINE

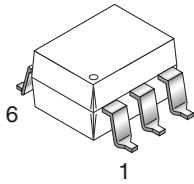

H11AV1S-M, H11AV2S-M

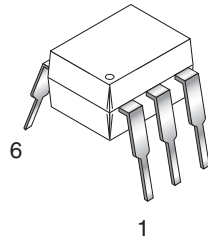

H11AV1-M, H11AV2-M

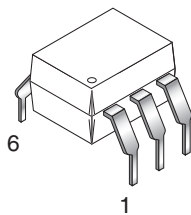

H11AV1A-M, H11AV2A-M

SCHEMATIC

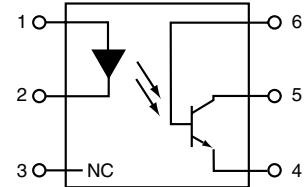

- PIN 1. ANODE
- 2. CATHODE
- 3. NO CONNECTION
- 4. EMITTER
- 5. COLLECTOR
- 6. BASE

DESCRIPTION

The general purpose optocouplers consist of a gallium arsenide infrared emitting diode driving a silicon phototransistor in a 6-pin dual in-line white package.

FEATURES

- H11AV1 and H11AV2 feature 0.3" input-output lead spacing
- H11AV1A and H11AV2A feature 0.4" input-output lead spacing
- UL recognized (File #E90700, Vol. 2)
- VDE recognized (File #102497)
- Add option V (e.g., H11AV1AV-M)

APPLICATIONS

- Power supply regulators
- Digital logic inputs
- Microprocessor inputs

H11AV1-M

H11AV1A-M

H11AV2-M

H11AV2A-M

ABSOLUTE MAXIMUM RATINGS ($T_A = 25^\circ\text{C}$ unless otherwise specified)

Parameter	Symbol	Value	Units
TOTAL DEVICE			
Storage Temperature	T_{STG}	-40 to +150	$^\circ\text{C}$
Operating Temperature	T_{OPR}	-40 to +100	$^\circ\text{C}$
Wave solder temperature (see page 9 for reflow solder profiles)	T_{SOL}	260 for 10 sec	$^\circ\text{C}$
Total Device Power Dissipation @ $T_A = 25^\circ\text{C}$	P_D	250	mW
Derate above 25°C		2.94	mW/ $^\circ\text{C}$
EMITTER			
DC/Average Forward Input Current	I_F	60	mA
Reverse Input Voltage	V_R	6	V
LED Power Dissipation @ $T_A = 25^\circ\text{C}$	P_D	120	mW
Derate above 25°C		1.41	mW/ $^\circ\text{C}$
DETECTOR			
Collector-Emitter Voltage	V_{CEO}	70	V
Collector-Base Voltage	V_{CBO}	70	V
Emitter-Collector Voltage	V_{ECO}	7	V
Detector Power Dissipation @ $T_A = 25^\circ\text{C}$	P_D	150	mW
Derate above 25°C		1.76	mW/ $^\circ\text{C}$

H11AV1-M

H11AV1A-M

H11AV2-M

H11AV2A-M

ELECTRICAL CHARACTERISTICS ($T_A = 25^\circ\text{C}$ unless otherwise specified)

INDIVIDUAL COMPONENT CHARACTERISTICS

Parameter	Test Conditions	Symbol	Min	Typ*	Max	Unit
EMITTER						
Input Forward Voltage ($I_F = 10\text{ mA}$)	$T_A = 25^\circ\text{C}$	V_F	0.8	1.18	1.5	V
	$T_A = -55^\circ\text{C}$		0.9	1.28	1.7	
	$T_A = 100^\circ\text{C}$		0.7	1.05	1.4	
Reverse Leakage Current	($V_R = 6.0\text{ V}$)	I_R			10	μA
DETECTOR						
Collector-Emitter Breakdown Voltage	($I_C = 1.0\text{ mA}$, $I_F = 0$)	BV_{CEO}	70	100		V
Collector-Base Breakdown Voltage	($I_C = 100\ \mu\text{A}$, $I_F = 0$)	BV_{CBO}	70	120		V
Emitter-Collector Breakdown Voltage	($I_E = 100\ \mu\text{A}$, $I_F = 0$)	BV_{ECO}	7	10		V
Collector-Emitter Dark Current	($V_{CE} = 10\text{ V}$, $I_F = 0$)	I_{CEO}		1	50	nA
Collector-Base Dark Current	($V_{CB} = 10\text{ V}$)	I_{CBO}		0.5		nA
Capacitance	($V_{CE} = 0\text{ V}$, $f = 1\text{ MHz}$)	C_{CE}		8		pF

ISOLATION CHARACTERISTICS

Characteristic	Test Conditions	Symbol	Min	Typ*	Max	Units
Input-Output Isolation Voltage	($f = 60\text{ Hz}$, $t = 1\text{ sec}$)	V_{ISO}	7500			Vac(pk)
Isolation Resistance	($V_{I-O} = 500\text{ VDC}$)	R_{ISO}	10^{11}			Ω
Isolation Capacitance	($V_{I-O} = 0\text{ V}$, $f = 1\text{ MHz}$)	C_{ISO}		0.2	2	pF

Note

* Typical values at $T_A = 25^\circ\text{C}$

H11AV1-M

H11AV1A-M

H11AV2-M

H11AV2A-M

TRANSFER CHARACTERISTICS ($T_A = 25^\circ\text{C}$ Unless otherwise specified.)

DC Characteristic	Test Conditions	Symbol	Device	Min	Typ*	Max	Unit
Current Transfer Ratio, Collector to Emitter	$(I_F = 10 \text{ mA}, V_{CE} = 10 \text{ V})$	CTR	H11AV1 H11AV1A	100		300	%
			H11AV2 H11AV2A	50			
Collector-Emitter Saturation Voltage	$(I_C = 2 \text{ mA}, I_F = 20 \text{ mA})$	$V_{CE(SAT)}$	All			0.4	V
AC Characteristic							
Non-Saturated Turn-on Time	$(I_C = 2 \text{ mA}, V_{CC} = 10 \text{ V}, R_L = 100\Omega)$ (Fig. 11)	T_{ON}	All			15	μs
Non Saturated Turn-off Time	$(I_C = 2 \text{ mA}, V_{CC} = 10 \text{ V}, R_L = 100\Omega)$ (Fig. 11)	T_{ON}	All			15	μs

* Typical values at $T_A = 25^\circ\text{C}$

TYPICAL PERFORMANCE CURVES

Fig. 1 LED Forward Voltage vs. Forward Current

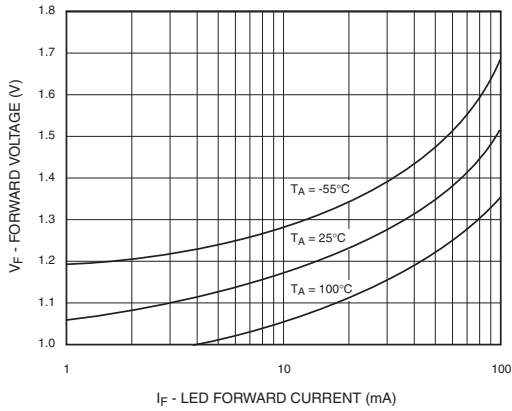

Fig. 2 Normalized CTR vs. Forward Current

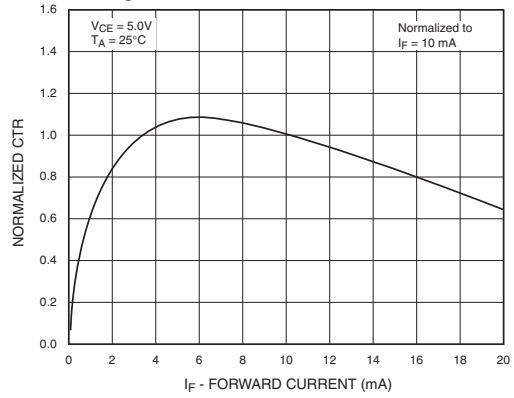

Fig. 3 Normalized CTR vs. Ambient Temperature

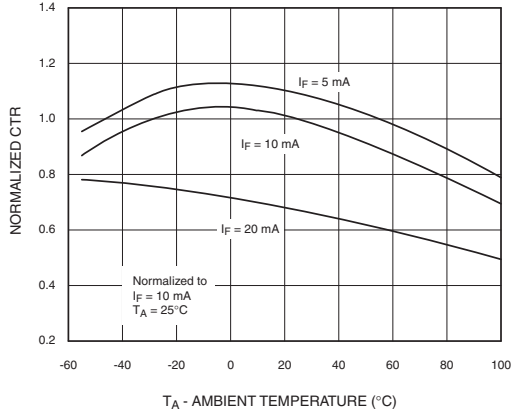

Fig. 4 CTR vs. R_{BE} (Unsaturated)

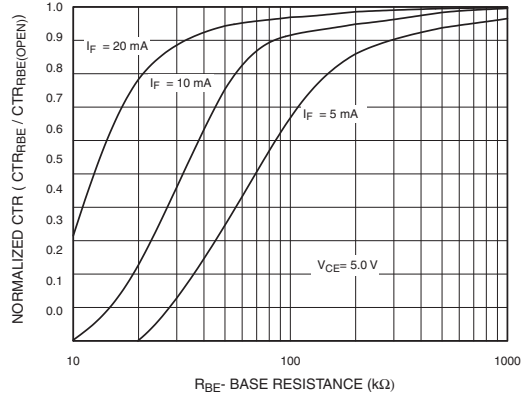

Fig. 5 CTR vs. R_{BE} (Saturated)

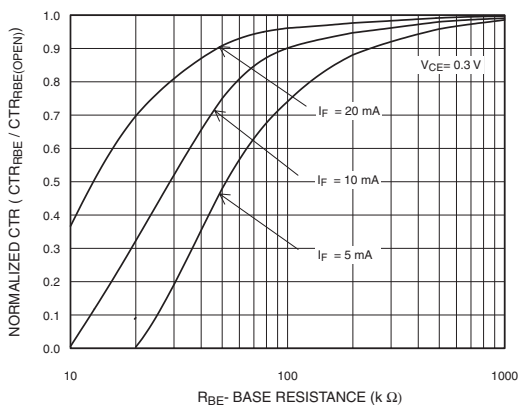
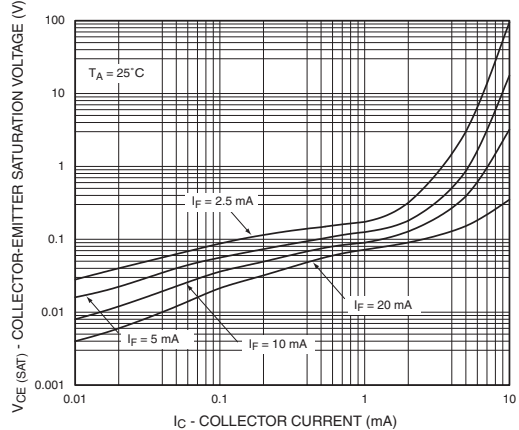

Fig. 6 Collector-Emitter Saturation Voltage vs. Collector Current



H11AV1-M

H11AV1A-M

H11AV2-M

H11AV2A-M

Fig. 7 Switching Speed vs. Load Resistor

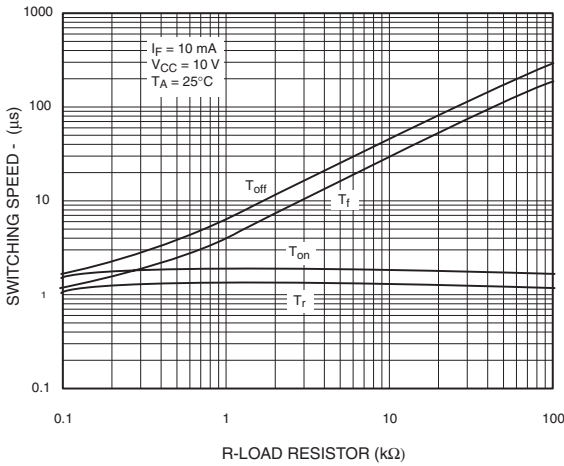

Fig. 8 Normalized t_{on} vs. R_{BE}

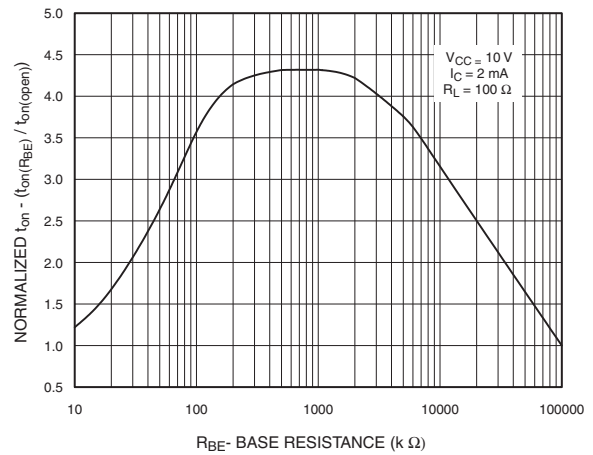

Fig. 9 Normalized t_{off} vs. R_{BE}

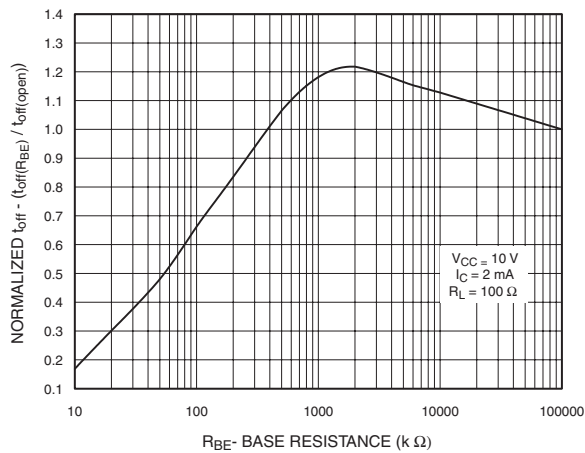

Fig. 10 Dark Current vs. Ambient Temperature

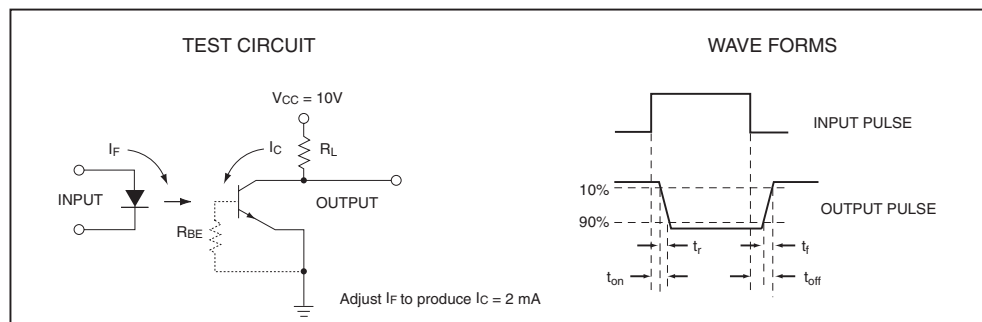
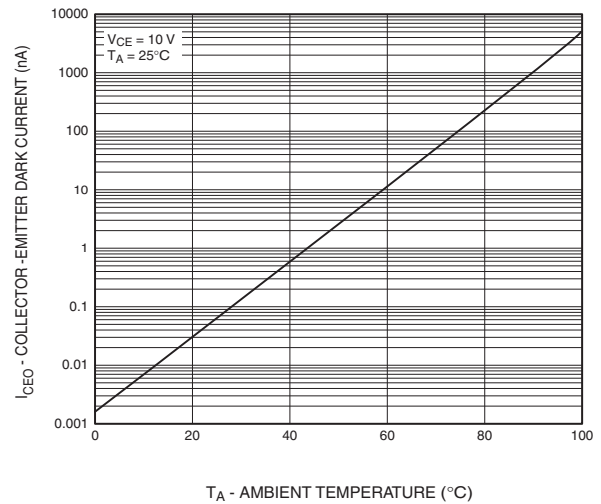

Figure 11. Switching Time Test Circuit and Waveforms

H11AV1-M

H11AV1A-M

H11AV2-M

H11AV2A-M

Package Dimensions (Through Hole)

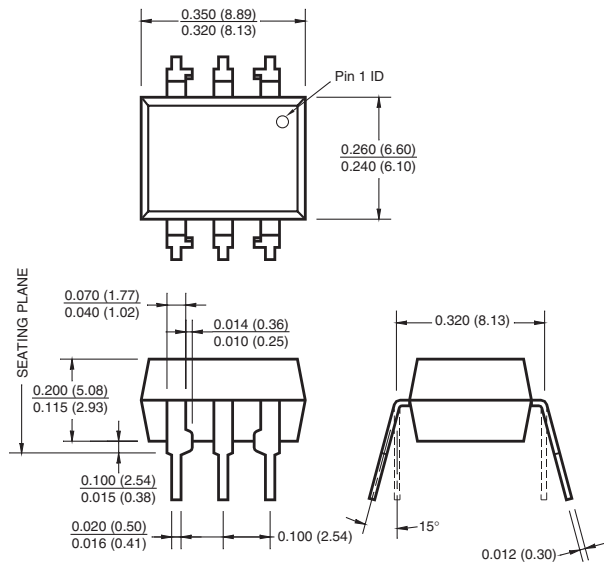

Package Dimensions (Surface Mount)

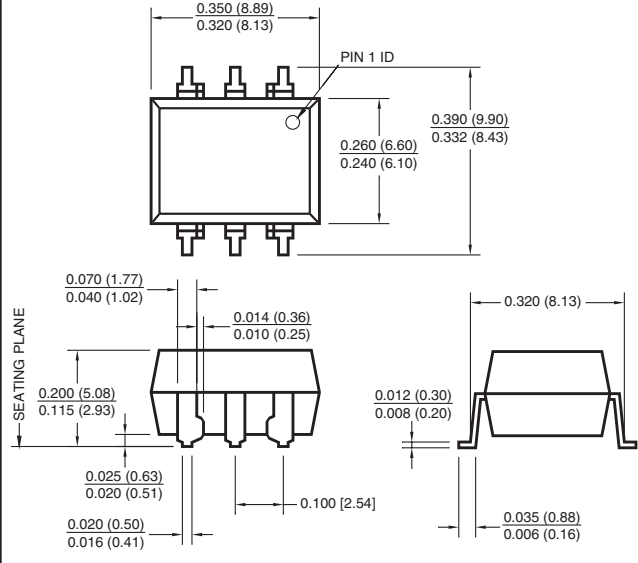

Package Dimensions (0.4" Lead Spacing)

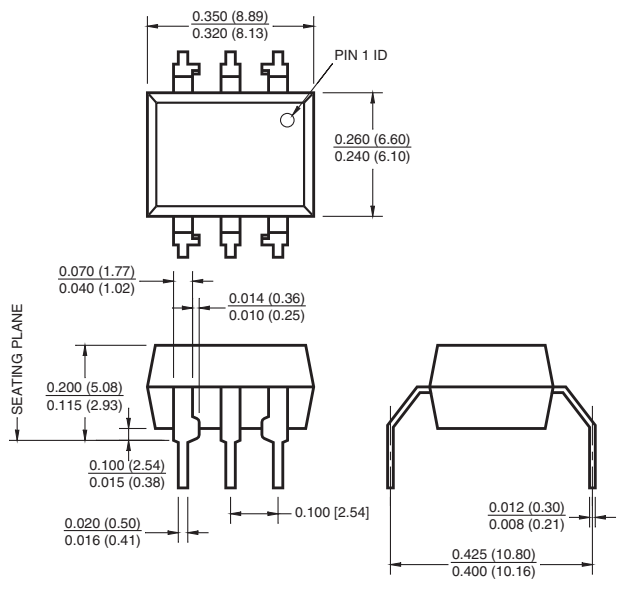

Recommended Pad Layout for Surface Mount Leadform

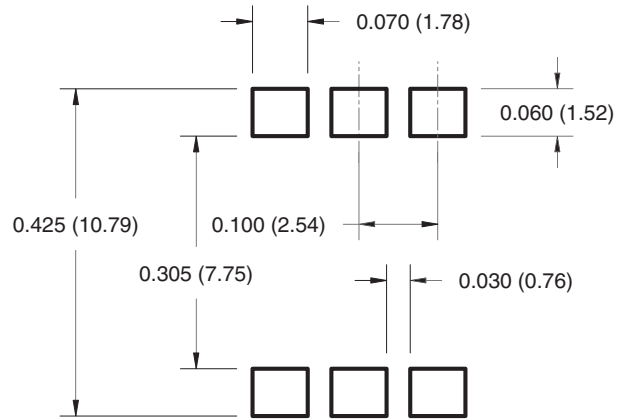

NOTE

All dimensions are in inches (millimeters)

H11AV1-M

H11AV1A-M

H11AV2-M

H11AV2A-M

ORDERING INFORMATION

Order Entry Identifier		
Order Entry Identifier	Option	Example
S	Surface Mount Lead Bend	H11AV1S-M
SR2	Surface Mount; Tape and reel	H11AV1SR2-M
N/A	0.4" Lead Spacing	H11AV1A-M
V	VDE 0884	H11AV1V-M
N/A	VDE 0884, 0.4" Lead Spacing	H11AV1AV-M
SV	VDE 0884, Surface Mount	H11AV1SV-M
SR2V	VDE 0884, Surface Mount, Tape & Reel	H11AV1SR2V-M

MARKING INFORMATION

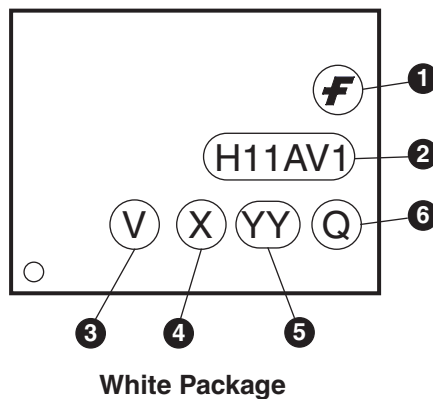

Definitions	
1	Fairchild logo
2	Device number
3	VDE mark (Note: Only appears on parts ordered with VDE option – See order entry table)
4	One digit year code • One digit for white package parts, e.g., '3'
5	Two digit work week ranging from '01' to '53'
6	Assembly package code

*Note – Parts built in the white package (M suffix) that do not have the 'V' option (see definition 3 above) that are marked with date code '325' or earlier are marked in the portrait format.

H11AV1-M

H11AV1A-M

H11AV2-M

H11AV2A-M

Carrier Tape Specifications

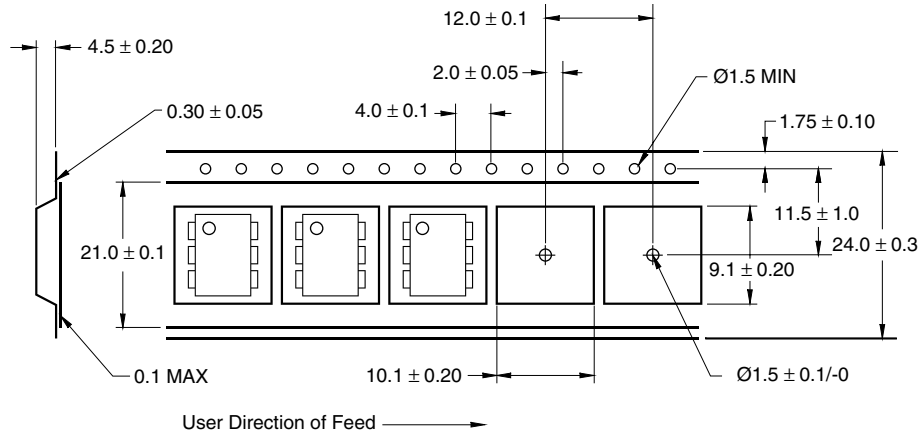

Reflow Profile

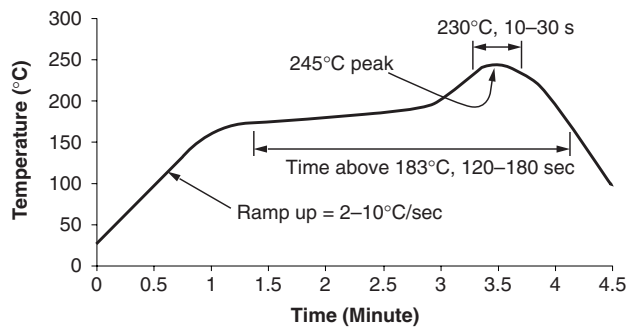

- Peak reflow temperature: 245°C (package surface temperature)
- Time of temperature higher than 183°C for 120-180 seconds
- One time soldering reflow is recommended

H11AV1-M

H11AV1A-M

H11AV2-M

H11AV2A-M

DISCLAIMER

FAIRCHILD SEMICONDUCTOR RESERVES THE RIGHT TO MAKE CHANGES WITHOUT FURTHER NOTICE TO ANY PRODUCTS HEREIN TO IMPROVE RELIABILITY, FUNCTION OR DESIGN. FAIRCHILD DOES NOT ASSUME ANY LIABILITY ARISING OUT OF THE APPLICATION OR USE OF ANY PRODUCT OR CIRCUIT DESCRIBED HEREIN; NEITHER DOES IT CONVEY ANY LICENSE UNDER ITS PATENT RIGHTS, NOR THE RIGHTS OF OTHERS.

LIFE SUPPORT POLICY

FAIRCHILD'S PRODUCTS ARE NOT AUTHORIZED FOR USE AS CRITICAL COMPONENTS IN LIFE SUPPORT DEVICES OR SYSTEMS WITHOUT THE EXPRESS WRITTEN APPROVAL OF THE PRESIDENT OF FAIRCHILD SEMICONDUCTOR CORPORATION. As used herein:

1. Life support devices or systems are devices or systems which, (a) are intended for surgical implant into the body, or (b) support or sustain life, and (c) whose failure to perform when properly used in accordance with instructions for use provided in the labeling, can be reasonably expected to result in a significant injury of the user.
2. A critical component in any component of a life support device or system whose failure to perform can be reasonably expected to cause the failure of the life support device or system, or to affect its safety or effectiveness.