

FXL2T245

Low Voltage Dual Supply 2-Bit Signal Translator with Configurable Voltage Supplies and Signal Levels and 3-STATE Outputs

General Description

The FXL2T245 is a configurable dual-voltage-supply translator designed for both uni-directional and bi-directional voltage translation between two logic levels. The device allows translation between voltages as high as 3.6V to as low as 1.1V. The A Port tracks the V_{CCA} level, and the B Port tracks the V_{CCB} level. This allows for bi-directional voltage translation over a variety of voltage levels: 1.2V, 1.5V, 1.8V, 2.5V, and 3.3V.

The device remains in 3-STATE until both V_{CC} s reach active levels allowing either V_{CC} to be powered-up first. Internal power down control circuits place the device in 3-STATE if either V_{CC} is removed.

The Transmit/Receive (T/\bar{R}) input determines the direction of data flow through the device. The \overline{OE} input, when HIGH, disables both the A and B Ports by placing them in a 3-STATE condition. The FXL2T245 is designed so that the control pins (T/\bar{R} and \overline{OE}) are supplied by V_{CCA} .

Features

- Bi-directional interface between any 2 levels from 1.1V to 3.6V
- Fully configurable, inputs track V_{CC} level
- Non-preferential power-up sequencing; either V_{CC} may be powered-up first
- No power-up sequencing required
- Outputs remain in 3-STATE until active V_{CC} level is reached
- Outputs switch to 3-STATE if either V_{CC} is at GND
- Power-off protection
- Control inputs (T/\bar{R} , \overline{OE}) levels are referenced to V_{CCA} voltage
- Packaged in 10-lead Pb-Free MicroPak (1.6mm x 2.1mm) package
- ESD protection exceeds:
 - 4kV HBM ESD (per JESD22-A114 & Mil Std 883e 3015.7)
 - 8kV HBM I/O to GND ESD (per JESD22-A114 & Mil Std 883e 3015.7)
 - 1kV CDM ESD (per ESD STM 5.3)
 - 200V MM ESD (per JESD22-A115 & ESD STM5.2)

Ordering Code:

Order Number	Package Number	Package Description
FXL2T245L10X	MAC010A	Pb-Free 10-Lead MicroPak, 1.6 mm x 2.1mm

Pb-Free package per JEDEC J-STD-020B.

FXL2T245 Low Voltage Dual Supply 2-Bit Signal Translator with Configurable Voltage Supplies and Signal Levels and 3-STATE Outputs

Pin Descriptions

Pin Names	Description
\overline{OE}	Output Enable Input
T/\overline{R}	Transmit/Receive Input
A_n	Side A Inputs or 3-STATE Outputs
B_n	Side B Inputs or 3-STATE Outputs
V_{CCA}	Side A Power Supply
V_{CCB}	Side B Power Supply
GND	Ground

Truth Table

Inputs		Outputs
\overline{OE}	T/\overline{R}	
L	L	Bus B Data to Bus A
L	H	Bus A Data to Bus B

H = HIGH Voltage Level
 L = LOW Voltage Level
 X = Don't Care

Connection Diagram

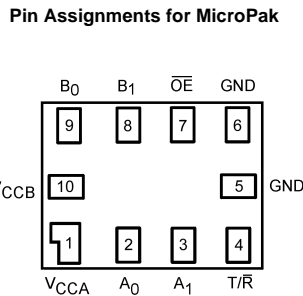

Pin Assignment

Pin Number	Terminal Name
1	V_{CCA}
2	A_0
3	A_1
4	T/\overline{R}
5	GND
6	GND
7	\overline{OE}
8	B_1
9	B_0
10	V_{CCB}

Power-Up/Power-Down Sequencing

FXL translators offer an advantage in that either V_{CC} may be powered up first. This benefit derives from the chip design. When either V_{CC} is at 0 volts, outputs are in a HIGH-Impedance state. The control inputs (T/\overline{R} and \overline{OE}) are designed to track the V_{CCA} supply. A pull-up resistor tying \overline{OE} to V_{CCA} should be used to ensure that bus contention, excessive currents, or oscillations do not occur during power-up/power-down. The size of the pull-up resistor is based upon the current-sinking capability of the \overline{OE} driver.

The recommended power-up sequence is the following:

1. Apply power to either V_{CC} .
2. Apply power to the T/\overline{R} input (Logic HIGH for A-to-B operation; Logic LOW for B-to-A operation) and to the respective data inputs (A Port or B Port). This may occur at the same time as Step 1.
3. Apply power to other V_{CC} .
4. Drive the \overline{OE} input LOW to enable the device.

The recommended power-down sequence is the following:

1. Drive \overline{OE} input HIGH to disable the device.
2. Remove power from either V_{CC} .
3. Remove power from other V_{CC} .

Absolute Maximum Ratings (Note 1)		Recommended Operating Conditions (Note 3)	
Supply Voltage		Power Supply Operating (V_{CCA} or V_{CCB})	1.1V to 3.6V
V_{CCA}	-0.5V to +4.6V	Input Voltage	
V_{CCB}	-0.5V to +4.6V	Port A	0.0V to 3.6V
DC Input Voltage (V_I)		Port B	0.0V to 3.6V
I/O Port A	-0.5V to +4.6V	Control Inputs ($\overline{T/R}$, \overline{OE})	0.0V to V_{CCA}
I/O Port B	-0.5V to +4.6V	Output Current in I_{OH}/I_{OL}	
Control Inputs ($\overline{T/R}$, \overline{OE})	-0.5V to +4.6V	V_{CC}	
Output Voltage (V_O) (Note 2)		3.0V to 3.6V	± 24 mA
Outputs 3-STATE	-0.5V to +4.6V	2.3V to 2.7V	± 18 mA
Outputs Active (A_n)	-0.5V to $V_{CCA} + 0.5V$	1.65V to 1.95V	± 6 mA
Outputs Active (B_n)	-0.5V to $V_{CCB} + 0.5V$	1.4V to 1.65V	± 2 mA
DC Input Diode Current (I_{IK}) $V_I < 0V$	-50 mA	1.1V to 1.4V	± 0.5 mA
DC Output Diode Current (I_{OK})		Free Air Operating Temperature (T_A)	-40°C to +85°C
$V_O < 0V$	-50 mA	Minimum Input Edge Rate ($\Delta V/\Delta t$)	
$V_O > V_{CC}$	+50 mA	$V_{CCA/B} = 1.1V$ to 3.6V	10 ns/V
DC Output Source/Sink Current (I_{OH}/I_{OL})	-50 mA / +50 mA		
DC V_{CC} or Ground Current per Supply Pin (I_{CC})	± 100 mA		
Storage Temperature Range (T_{STG})	-65°C to +150°C		

Note 1: The "Absolute Maximum Ratings" are those values beyond which the safety of the device cannot be guaranteed. The device should not be operated at these limits. The parametric values defined in the Electrical Characteristics tables are not guaranteed at the absolute maximum ratings. The "Recommended Operating Conditions" table will define the conditions for actual device operation.

Note 2: I_O Absolute Maximum Rating must be observed.

Note 3: All unused inputs must be held at V_{CCI} or GND.

DC Electrical Characteristics

Symbol	Parameter	Conditions	V_{CCI} (V)	V_{CCO} (V)	Min	Max	Units
V_{IH} (Note 4)	High Level Input Voltage	Data Inputs A_n, B_n	2.7 - 3.6	1.1 - 3.6	2.0		V
			2.3 - 2.7		1.6		
			1.65 - 2.3		$0.65 \times V_{CCI}$		
			1.4 - 1.65		$0.65 \times V_{CCI}$		
			1.1 - 1.4		$0.9 \times V_{CCI}$		
		Control Pins/ \overline{OE} , $\overline{T/R}$ (Referenced to V_{CCA})	2.7 - 3.6	1.1 - 3.6	2.0		
			2.3 - 2.7		1.6		
			1.65 - 2.3		$0.65 \times V_{CCA}$		
			1.4 - 1.65		$0.65 \times V_{CCA}$		
			1.1 - 1.4		$0.9 \times V_{CCA}$		
V_{IL} (Note 4)	Low Level Input Voltage	Data Inputs A_n, B_n	2.7 - 3.6	1.1 - 3.6		0.8	V
			2.3 - 2.7			0.7	
			1.65 - 2.3		$0.35 \times V_{CCI}$		
			1.4 - 1.65		$0.35 \times V_{CCI}$		
			1.1 - 1.4		$0.1 \times V_{CCI}$		
		Control Pins/ \overline{OE} , $\overline{T/R}$ (Referenced to V_{CCA})	2.7 - 3.6	1.1 - 3.6		0.8	
			2.3 - 2.7			0.7	
			1.65 - 2.3		$0.35 \times V_{CCA}$		
			1.4 - 1.65		$0.35 \times V_{CCA}$		
			1.1 - 1.4		$0.1 \times V_{CCA}$		

DC Electrical Characteristics (Continued)							
Symbol	Parameter	Conditions	V _{CCA} (V)	V _{CCB} (V)	Min	Max	Units
V _{OH} (Note 5)	High Level Output Voltage	I _{OH} = -100 μA	1.1 - 3.6	1.1 - 3.6	V _{CC0} - 0.2		V
		I _{OH} = -12 mA	2.7	2.7	2.2		
		I _{OH} = -18 mA	3.0	3.0	2.4		
		I _{OH} = -24 mA	3.0	3.0	2.2		
		I _{OH} = -6 mA	2.3	2.3	2.0		
		I _{OH} = -12 mA	2.3	2.3	1.8		
		I _{OH} = -18 mA	2.3	2.3	1.7		
		I _{OH} = -6 mA	1.65	1.65	1.25		
V _{OL} (Note 5)	Low Level Output Voltage	I _{OL} = 100 μA	1.1 - 3.6	1.1 - 3.6		0.2	V
		I _{OL} = 12 mA	2.7	2.7		0.4	
		I _{OL} = 18 mA	3.0	3.0		0.4	
		I _{OL} = 24 mA	3.0	3.0		0.55	
		I _{OL} = 12 mA	2.3	2.3		0.4	
		I _{OL} = 18 mA	2.3	2.3		0.6	
		I _{OL} = 6 mA	1.65	1.65		0.3	
		I _{OL} = 2 mA	1.4	1.4		0.35	
I _{OL} = 0.5 mA	1.1	1.1		0.3 x V _{CC0}			
I _I	Input Leakage Current. Control Pins	V _I = V _{CCA} or GND	1.1 - 3.6	3.6		±1.0	μA
I _{OFF}	Power Off Leakage Current	A _n , V _I or V _O = 0V to 3.6V	0	3.6		±10.0	μA
		B _n , V _I or V _O = 0V to 3.6V	3.6	0		±10.0	
I _{OZ} (Note 6)	3-STATE Output Leakage 0 ≤ V _O ≤ 3.6V V _I = V _{IH} or V _{IL}	A _n , B _n \overline{OE} = V _{IH}	3.6	3.6		±10.0	μA
		B _n , \overline{OE} = Don't Care	0	3.6		+10.0	
		A _n , \overline{OE} = Don't Care	3.6	0		+10.0	
I _{CCA/B} (Note 7)	Quiescent Supply Current	V _I = V _{CCI} or GND; I _O = 0	1.1 - 3.6	1.1 - 3.6		20.0	μA
I _{CCZ} (Note 7)	Quiescent Supply Current	V _I = V _{CCI} or GND; I _O = 0	1.1 - 3.6	1.1 - 3.6		20.0	μA
I _{CCA}	Quiescent Supply Current	V _I = V _{CCA} or GND; I _O = 0	0	1.1 - 3.6		-10.0	μA
		V _I = V _{CCA} or GND; I _O = 0	1.1 - 3.6	0		10.0	
I _{CCB}	Quiescent Supply Current	V _I = V _{CCB} or GND; I _O = 0	1.1 - 3.6	0		-10.0	μA
		V _I = V _{CCB} or GND; I _O = 0	0	1.1 - 3.6		10.0	
ΔI _{CCA/B}	Increase in I _{CC} per Input; Other Inputs at V _{CC} or GND	V _{IH} = 3.0	3.6	3.6		500	μA

Note 4: V_{CCI} = the V_{CC} associated with the data input under test.

Note 5: V_{CC0} = the V_{CC} associated with the output under test.

Note 6: Don't Care = Any valid logic level.

Note 7: Reflects current per supply, V_{CCA} or V_{CCB}.

AC Electrical Characteristics $V_{CCA} = 3.0V$ to $3.6V$												
Symbol	Parameter	$T_A = -40^{\circ}C$ to $+85^{\circ}C$										Units
		$V_{CCB} = 3.0V$ to $3.6V$		$V_{CCB} = 2.3V$ to $2.7V$		$V_{CCB} = 1.65V$ to $1.95V$		$V_{CCB} = 1.4V$ to $1.6V$		$V_{CCB} = 1.1V$ to $1.3V$		
		Min	Max	Min	Max	Min	Max	Min	Max	Min	Max	
t_{PLH}, t_{PHL}	Propagation Delay A to B	0.2	3.5	0.3	3.9	0.5	5.4	0.6	6.8	1.4	22.0	ns
	Propagation Delay B to A	0.2	3.5	0.2	3.8	0.3	4.0	0.5	4.3	0.8	13.0	
t_{PZH}, t_{PZL}	Output Enable \overline{OE} to B	0.5	4.0	0.7	4.4	1.0	5.9	1.0	6.4	1.5	17.0	ns
	Output Enable \overline{OE} to A	0.5	4.0	0.5	4.0	0.5	4.0	0.5	4.0	0.5	4.0	
t_{PHZ}, t_{PLZ}	Output Disable \overline{OE} to B	0.2	3.8	0.2	4.0	0.7	4.8	1.5	6.2	2.0	17.0	ns
	Output Disable \overline{OE} to A	0.2	3.7	0.2	3.7	0.2	3.7	0.2	3.7	0.2	3.7	

AC Electrical Characteristics $V_{CCA} = 2.3V$ to $2.7V$												
Symbol	Parameter	$T_A = -40^{\circ}C$ to $+85^{\circ}C$										Units
		$V_{CCB} = 3.0V$ to $3.6V$		$V_{CCB} = 2.3V$ to $2.7V$		$V_{CCB} = 1.65V$ to $1.95V$		$V_{CCB} = 1.4V$ to $1.6V$		$V_{CCB} = 1.1V$ to $1.3V$		
		Min	Max	Min	Max	Min	Max	Min	Max	Min	Max	
t_{PLH}, t_{PHL}	Propagation Delay A to B	0.2	3.8	0.4	4.2	0.5	5.6	0.8	6.9	1.4	22.0	ns
	Propagation Delay B to A	0.3	3.9	0.4	4.2	0.5	4.5	0.5	4.8	1.0	7.0	
t_{PZH}, t_{PZL}	Output Enable \overline{OE} to B	0.6	4.2	0.8	4.6	1.0	6.0	1.0	6.8	1.5	17.0	ns
	Output Enable \overline{OE} to A	0.6	4.5	0.6	4.5	0.6	4.5	0.6	4.5	0.6	4.5	
t_{PHZ}, t_{PLZ}	Output Disable \overline{OE} to B	0.2	4.1	0.2	4.3	0.7	4.8	1.5	6.7	2.0	17.0	ns
	Output Disable \overline{OE} to A	0.2	4.0	0.2	4.0	0.2	4.0	0.2	4.0	0.2	4.0	

AC Electrical Characteristics $V_{CCA} = 1.65V$ to $1.95V$												
Symbol	Parameter	$T_A = -40^{\circ}C$ to $+85^{\circ}C$										Units
		$V_{CCB} = 3.0V$ to $3.6V$		$V_{CCB} = 2.3V$ to $2.7V$		$V_{CCB} = 1.65V$ to $1.95V$		$V_{CCB} = 1.4V$ to $1.6V$		$V_{CCB} = 1.1V$ to $1.3V$		
		Min	Max	Min	Max	Min	Max	Min	Max	Min	Max	
t_{PLH}, t_{PHL}	Propagation Delay A to B	0.3	4.0	0.5	4.5	0.8	5.7	0.9	7.1	1.5	22.0	ns
	Propagation Delay B to A	0.5	5.4	0.5	5.6	0.8	5.7	1.0	6.0	1.2	8.0	
t_{PZH}, t_{PZL}	Output Enable \overline{OE} to B	0.6	5.2	0.8	5.4	1.2	6.9	1.2	7.2	1.5	18.0	ns
	Output Enable \overline{OE} to A	1.0	6.7	1.0	6.7	1.0	6.7	1.0	6.7	1.0	6.7	
t_{PHZ}, t_{PLZ}	Output Disable \overline{OE} to B	0.2	5.1	0.2	5.2	0.8	5.2	1.5	7.0	2.0	17.0	ns
	Output Disable \overline{OE} to A	0.5	5.0	0.5	5.0	0.5	5.0	0.5	5.0	0.5	5.0	

AC Electrical Characteristics $V_{CCA} = 1.4V$ to $1.6V$												
Symbol	Parameter	$T_A = -40^{\circ}C$ to $+85^{\circ}C$										Units
		$V_{CCB} = 3.0V$ to $3.6V$		$V_{CCB} = 2.3V$ to $2.7V$		$V_{CCB} = 1.65V$ to $1.95V$		$V_{CCB} = 1.4V$ to $1.6V$		$V_{CCB} = 1.1V$ to $1.3V$		
		Min	Max	Min	Max	Min	Max	Min	Max	Min	Max	
t_{PLH}, t_{PHL}	Propagation Delay A to B	0.5	4.3	0.5	4.8	1.0	6.0	1.0	7.3	1.5	22.0	ns
	Propagation Delay B to A	0.6	6.8	0.8	6.9	0.9	7.1	1.0	7.3	1.3	9.5	
t_{PZH}, t_{PZL}	Output Enable \overline{OE} to B	1.1	7.5	1.1	7.6	1.3	7.7	1.4	7.9	2.0	20.0	ns
	Output Enable \overline{OE} to A	1.0	7.5	1.0	7.5	1.0	7.5	1.0	7.5	1.0	7.5	
t_{PHZ}, t_{PLZ}	Output Disable \overline{OE} to B	0.4	6.1	0.4	6.2	0.9	6.2	1.5	7.5	2.0	18.0	ns
	Output Disable \overline{OE} to A	1.0	6.0	1.0	6.0	1.0	6.0	1.0	6.0	1.0	6.0	

AC Electrical Characteristics $V_{CCA} = 1.1V$ to $1.3V$

Symbol	Parameter	$T_A = -40^{\circ}C$ to $+85^{\circ}C$										Units
		$V_{CCB} = 3.0V$ to $3.6V$		$V_{CCB} = 2.3V$ to $2.7V$		$V_{CCB} = 1.65V$ to $1.95V$		$V_{CCB} = 1.4V$ to $1.6V$		$V_{CCB} = 1.1V$ to $1.3V$		
		Min	Max	Min	Max	Min	Max	Min	Max	Min	Max	
t_{PLH}, t_{PHL}	Propagation Delay A to B	0.8	13.0	1.0	7.0	1.2	8.0	1.3	9.5	2.0	24.0	ns
	Propagation Delay B to A	1.4	22.0	1.4	22.0	1.5	22.0	1.5	22.0	2.0	24.0	
t_{PZH}, t_{PZL}	Output Enable \overline{OE} to B	1.0	12.0	1.0	9.0	2.0	10.0	2.0	11.0	2.0	24.0	ns
	Output Enable \overline{OE} to A	2.0	22.0	2.0	22.0	2.0	22.0	2.0	22.0	2.0	22.0	
t_{PHZ}, t_{PLZ}	Output Disable \overline{OE} to B	1.0	15.0	0.7	7.0	1.0	8.0	2.0	10.0	2.0	20.0	ns
	Output Disable \overline{OE} to A	2.0	15.0	2.0	12.0	2.0	12.0	2.0	12.0	2.0	12.0	

Capacitance

Symbol	Parameter	Conditions	$T_A = +25^{\circ}C$	Units
			Typical	
C_{IN}	Input Capacitance Control Pins (\overline{OE} , T/R)	$V_{CCA} = V_{CCB} = 3.3V, V_I = 0V$ or $V_{CCA/B}$	4.0	pF
C_{IO}	Input/Output Capacitance A_n, B_n Ports	$V_{CCA} = V_{CCB} = 3.3V, V_I = 0V$ or $V_{CCA/B}$	5.0	pF
C_{PD}	Power Dissipation Capacitance	$V_{CCA} = V_{CCB} = 3.3V, V_I = 0V$ or $V_{CC}, F = 10$ MHz	20.0	pF

AC Loading and Waveforms

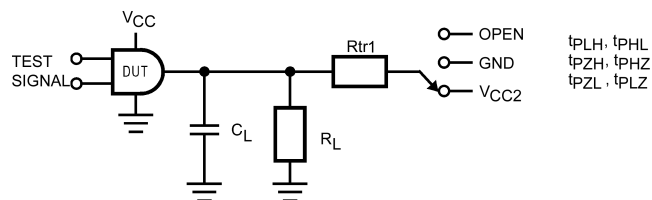

TEST	SWITCH
t_{PLH} , t_{PHL}	OPEN
t_{PLZ} , t_{PZL}	$V_{CC0} \times 2$ at $V_{CC0} = 3.3 \pm 0.3V, 2.5V \pm 0.2V, 1.8V \pm 0.15V, 1.5V \pm 0.1V, 1.2V \pm 0.1V$
t_{PHZ} , t_{PZH}	GND

FIGURE 1. AC Test Circuit

AC Load Table

V_{CC0}	C_L	R_L	R_{tr1}
$1.2V \pm 0.1V$	15 pF	2 k Ω	2 k Ω
$1.5V \pm 0.1V$	15 pF	2 k Ω	2 k Ω
$1.8V \pm 0.15V$	15 pF	2 k Ω	2 k Ω
$2.5V \pm 0.2V$	15 pF	2 k Ω	2 k Ω
$3.3V \pm 0.3V$	15 pF	2 k Ω	2 k Ω

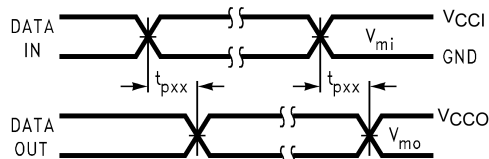

Note: Input $t_R = t_F = 2.0$ ns, 10% to 90%
 Input $t_R = t_F = 2.5$ ns, 10% to 90%, @ $V_I = 3.0V$ to $3.6V$ only

FIGURE 2. Waveform for Inverting and Non-Inverting Functions

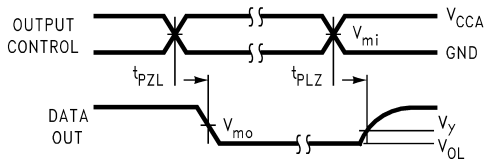

Note: Input $t_R = t_F = 2.0$ ns, 10% to 90%
 Input $t_R = t_F = 2.5$ ns, 10% to 90%, @ $V_I = 3.0V$ to $3.6V$ only

FIGURE 3. 3-STATE Output Low Enable and Disable Times for Low Voltage Logic

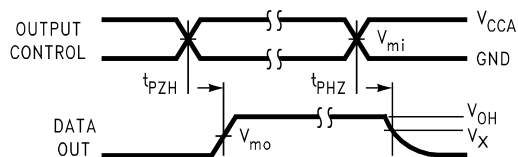

Note: Input $t_R = t_F = 2.0$ ns, 10% to 90%
 Input $t_R = t_F = 2.5$ ns, 10% to 90%, @ $V_I = 3.0V$ to $3.6V$ only

FIGURE 4. 3-STATE Output High Enable and Disable Times for Low Voltage Logic

Symbol	V_{CC}				
	$3.3V \pm 0.3V$	$2.5V \pm 0.2V$	$1.8V \pm 0.15V$	$1.5V \pm 0.1V$	$1.2V \pm 0.1V$
V_{mi}	$V_{CCi}/2$	$V_{CCi}/2$	$V_{CCi}/2$	$V_{CCi}/2$	$V_{CCi}/2$
V_{mo}	$V_{CC0}/2$	$V_{CC0}/2$	$V_{CC0}/2$	$V_{CC0}/2$	$V_{CC0}/2$
V_X	$V_{OH} - 0.3V$	$V_{OH} - 0.15V$	$V_{OH} - 0.15V$	$V_{OH} - 0.1V$	$V_{OH} - 0.1V$
V_Y	$V_{OL} + 0.3V$	$V_{OL} + 0.15V$	$V_{OL} + 0.15V$	$V_{OL} + 0.1V$	$V_{OL} + 0.1V$

Note: For V_{mi} : $V_{CCi} = V_{CCA}$ for Control Pins $\overline{T}/\overline{R}$ and \overline{OE} , or $V_{CCA}/2$

Tape and Reel Specification

Tape Format for MicroPak 10

Package Designator	Tape Section	Number Cavities	Cavity Status	Cover Tape Status
L10X	Leader (Start End)	125 (typ)	Empty	Sealed
	Carrier	5000	Filled	Sealed
	Trailer (Hub End)	75 (typ)	Empty	Sealed

TAPE DIMENSIONS inches (millimeters)

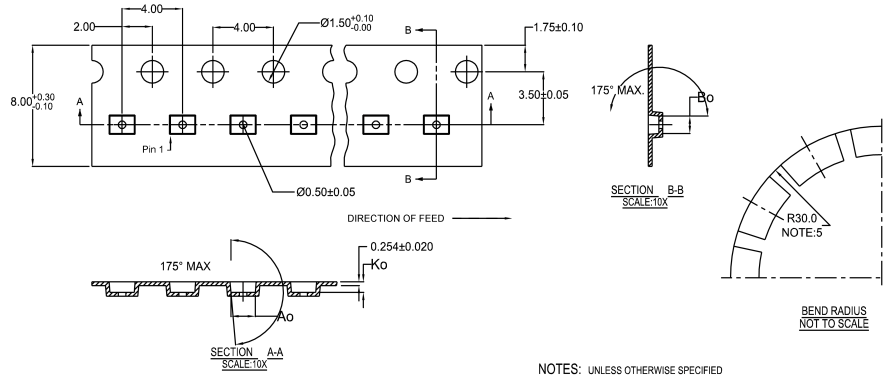

10	300056	2.30±0.05	1.78±0.05	0.68±0.05
8	300038	1.78±0.05	1.78±0.05	0.68±0.05
6	300033	1.60±0.05	1.15±0.05	0.70±0.05

NOTES: UNLESS OTHERWISE SPECIFIED

1. ACCUMULATED 50 SPROCKETS. SPROCKET HOLE PITCH IS 200.00 ±0.30MM
2. NO INDICATED CORNER RADIUS IS 0.127MM
3. CAMBER NOT TO EXCEED 1MM IN 100MM
4. SMALLEST ALLOWABLE BENDING RADIUS
5. POCKET POSITION RELATIVE TO SPROCKET HOLE MEASURED AS TRUE POSITION OF POCKET, NOT POCKET HOLE

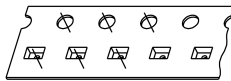

SCALE: 6X

REEL DIMENSIONS inches (millimeters)

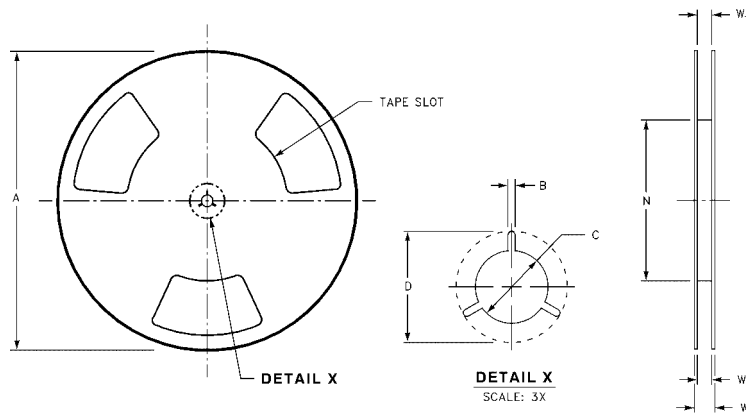

Tape Size	A	B	C	D	N	W1	W2	W3
8 mm	7.0 (177.8)	0.059 (1.50)	0.512 (13.00)	0.795 (20.20)	2.165 (55.00)	0.331 + 0.059/-0.000 (8.40 + 1.50/-0.00)	0.567 (14.40)	W1 + 0.078/-0.039W (W1 + 2.00/-1.00)

Physical Dimensions inches (millimeters) unless otherwise noted

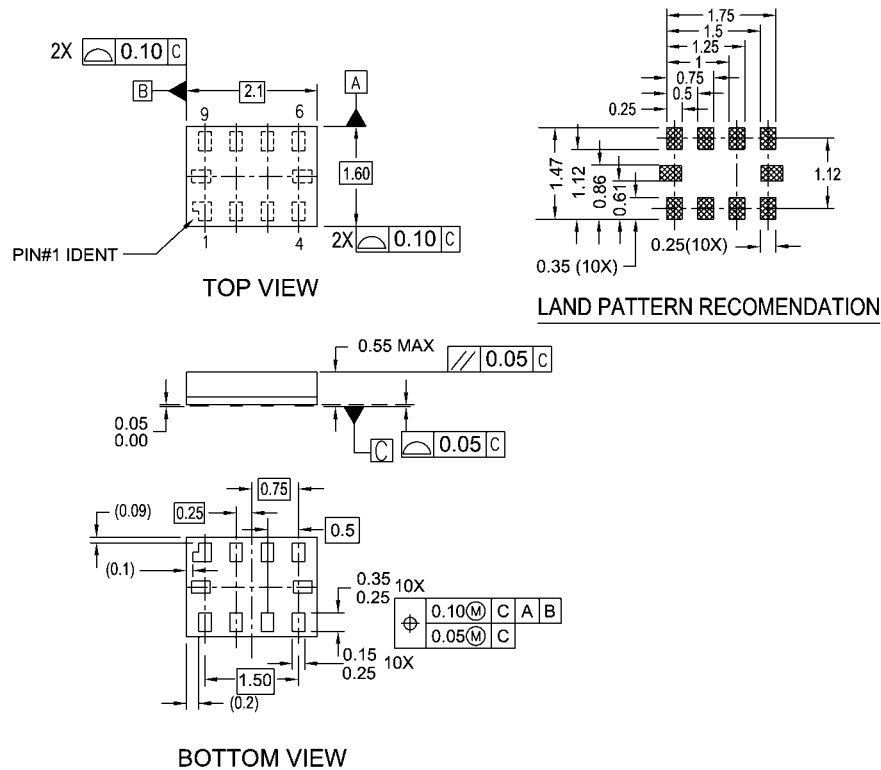

NOTES:

- A. PACKAGE CONFORMS TO JEDEC MO255, VARIATION UABD
- B. DIMENSIONS ARE IN MILLIMETERS.
- C. DIMENSIONS AND TOLERANCES CONFORMS TO ASME Y14.5M, 1994.

MAC010ARevB

**Pb-Free 10-Lead MicroPak, 1.6 mm x 2.1mm
Package Number MAC010A**

Fairchild does not assume any responsibility for use of any circuitry described, no circuit patent licenses are implied and Fairchild reserves the right at any time without notice to change said circuitry and specifications.

LIFE SUPPORT POLICY

FAIRCHILD'S PRODUCTS ARE NOT AUTHORIZED FOR USE AS CRITICAL COMPONENTS IN LIFE SUPPORT DEVICES OR SYSTEMS WITHOUT THE EXPRESS WRITTEN APPROVAL OF THE PRESIDENT OF FAIRCHILD SEMICONDUCTOR CORPORATION. As used herein:

1. Life support devices or systems are devices or systems which, (a) are intended for surgical implant into the body, or (b) support or sustain life, and (c) whose failure to perform when properly used in accordance with instructions for use provided in the labeling, can be reasonably expected to result in a significant injury to the user.
2. A critical component in any component of a life support device or system whose failure to perform can be reasonably expected to cause the failure of the life support device or system, or to affect its safety or effectiveness.

www.fairchildsemi.com