

74LVT574 • 74LVTH574

Low Voltage Octal D-Type Flip-Flop with 3-STATE Outputs

General Description

The LVT574 and LVTH574 are high-speed, low-power octal D-type flip-flop featuring separate D-type inputs for each flip-flop and 3-STATE outputs for bus-oriented applications. A buffered Clock (CP) and Output Enable (\overline{OE}) are common to all flip-flops.

The LVTH574 data inputs include bushold, eliminating the need for external pull-up resistors to hold unused inputs.

These octal flip-flops are designed for low-voltage (3.3V) V_{CC} applications, but with the capability to provide a TTL interface to a 5V environment. The LVT574 and LVTH574 are fabricated with an advanced BiCMOS technology to achieve high speed operation similar to 5V ABT while maintaining a low power dissipation.

Features

- Input and output interface capability to systems at 5V V_{CC}
- Bushold data inputs eliminate the need for external pull-up resistors to hold unused inputs (74LVTH574), also available without bushold feature (74LVT574)
- Live insertion/extraction permitted
- Power Up/Down high impedance provides glitch-free bus loading
- Outputs source/sink -32 mA/+64 mA
- Functionally compatible with the 74 series 574
- Latch-up performance exceeds 500 mA
- ESD performance:
 - Human-body model > 2000V
 - Machine model > 200V
 - Charged-device model > 1000V

Ordering Code:

Order Number	Package Number	Package Description
74LVT574WM	M20B	20-Lead Small Outline Integrated Circuit (SOIC), JEDEC MS-013, 0.300" Wide
74LVT574SJ	M20D	Pb-Free 20-Lead Small Outline Package (SOP), EIAJ TYPE II, 5.3mm Wide
74LVT574MSA	MSA20	20-Lead Shrink Small Outline Package (SSOP), JEDEC MO-150, 5.3mm Wide
74LVT574MTC	MTC20	20-Lead Thin Shrink Small Outline Package (TSSOP), JEDEC MO-153, 4.4mm Wide
74LVT574MTCX_NL (Note 1)	MTC20	Pb-Free 20-Lead Thin Shrink Small Outline Package (TSSOP), JEDEC MO-153, 4.4mm Wide
74LVTH574WM	M20B	20-Lead Small Outline Integrated Circuit (SOIC), JEDEC MS-013, 0.300" Wide
74LVTH574SJ	M20D	Pb-Free 20-Lead Small Outline Package (SOP), EIAJ TYPE II, 5.3mm Wide
74LVTH574MSA	MSA20	20-Lead Shrink Small Outline Package (SSOP), JEDEC MO-150, 5.3mm Wide
74LVTH574MTC	MTC20	20-Lead Thin Shrink Small Outline Package (TSSOP), JEDEC MO-153, 4.4mm Wide
74LVTH574MTCX_NL (Note 1)	MTC20	Pb-Free 20-Lead Thin Shrink Small Outline Package (TSSOP), JEDEC MO-153, 4.4mm Wide

Device also available in Tape and Reel. Specify by appending suffix letter "X" to the ordering code.
Pb-Free package per JEDEC J-STD-020B.

Note 1: "_NL" indicates Pb-Free package (per JEDEC J-STD-020B). Device available in Tape and Reel only.

Logic Symbols

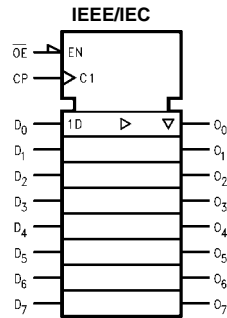
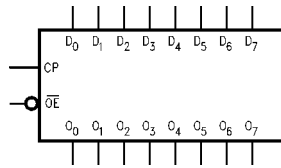

Pin Descriptions

Pin Names	Description
D ₀ -D ₇	Data Inputs
CP	Clock Pulse Input
\overline{OE}	3-STATE Output Enable Input
O ₀ -O ₇	3-STATE Outputs

Truth Table

Inputs			Outputs
D _n	CP	\overline{OE}	O _n
H	↗	L	H
L	↗	L	L
X	L	L	O _o
X	X	H	Z

H = HIGH Voltage Level
 L = LOW Voltage Level
 X = Immaterial
 Z = High Impedance
 ↗ = LOW-to-HIGH Transition
 O_o = Previous O_o before HIGH to LOW of CP

Connection Diagram

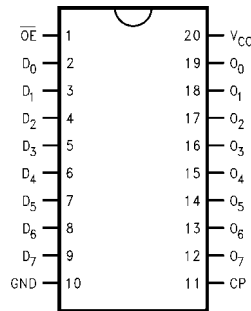

Functional Description

The LVT574 and LVTH574 consist of eight edge-triggered flip-flops with individual D-type inputs and 3-STATE true outputs. The buffered clock and buffered Output Enable are common to all flip-flops. The eight flip-flops will store the state of their individual D-type inputs that meet the setup and hold time requirements on the LOW-to-HIGH Clock (CP) transition. With the Output Enable (\overline{OE}) LOW, the contents of the eight flip-flops are available at the outputs. When the \overline{OE} is HIGH, the outputs go to the high impedance state. Operation of the \overline{OE} input does not affect the state of the flip-flops.

Logic Diagram

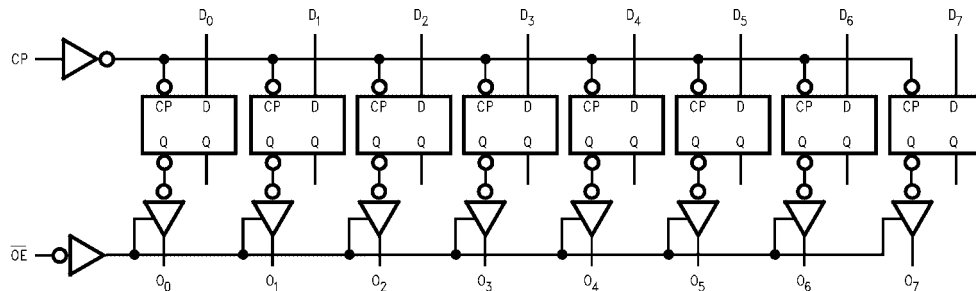

Please note that this diagram is provided only for the understanding of logic operations and should not be used to estimate propagation delays.

Absolute Maximum Ratings ^(Note 2)				
Symbol	Parameter	Value	Conditions	Units
V _{CC}	Supply Voltage	-0.5 to +4.6		V
V _I	DC Input Voltage	-0.5 to +7.0		V
V _O	DC Output Voltage	-0.5 to +7.0	Output in 3-STATE	V
		-0.5 to +7.0	Output in HIGH or LOW State (Note 3)	
I _{IK}	DC Input Diode Current	-50	V _I < GND	mA
I _{OK}	DC Output Diode Current	-50	V _O < GND	mA
I _O	DC Output Current	64	V _O > V _{CC} Output at HIGH State	mA
		128	V _O > V _{CC} Output at LOW State	
I _{CC}	DC Supply Current per Supply Pin	±64		mA
I _{GND}	DC Ground Current per Ground Pin	±128		mA
T _{STG}	Storage Temperature	-65 to +150		°C

Recommended Operating Conditions				
Symbol	Parameter	Min	Max	Units
V _{CC}	Supply Voltage	2.7	3.6	V
V _I	Input Voltage	0	5.5	V
I _{OH}	HIGH-Level Output Current		-32	mA
I _{OL}	LOW-Level Output Current		64	mA
T _A	Free-Air Operating Temperature	-40	85	°C
Δt/ΔV	Input Edge Rate, V _{IN} = 0.8V–2.0V, V _{CC} = 3.0V	0	10	ns/V

Note 2: Absolute Maximum continuous ratings are those values beyond which damage to the device may occur. Exposure to these conditions or conditions beyond those indicated may adversely affect device reliability. Functional operation under absolute maximum rated conditions is not implied.

Note 3: I_O Absolute Maximum Rating must be observed.

DC Electrical Characteristics

Symbol	Parameter	V _{CC} (V)	T _A = -40°C to +85°C			Units	Conditions	
			Min	Typ (Note 4)	Max			
V _{IK}	Input Clamp Diode Voltage	2.7			-1.2	V	I _I = -18 mA	
V _{IH}	Input HIGH Voltage	2.7–3.6	2.0			V	V _O ≤ 0.1V or V _O ≥ V _{CC} - 0.1V	
V _{IL}	Input LOW Voltage	2.7–3.6			0.8	V		
V _{OH}	Output HIGH Voltage	2.7–3.6	V _{CC} - 0.2			V	I _{OH} = -100 μA	
		2.7	2.4				I _{OH} = -8 mA	
		3.0	2.0				I _{OH} = -32 mA	
V _{OL}	Output LOW Voltage	2.7			0.2	V	I _{OL} = 100 μA	
		2.7			0.5		I _{OL} = 24 mA	
		3.0			0.4		I _{OL} = 16 mA	
		3.0			0.5		I _{OL} = 32 mA	
		3.0			0.55		I _{OL} = 64 mA	
I _{I(HOLD)} (Note 5)	Bushold Input Minimum Drive	3.0	75			μA	V _I = 0.8V	
			-75				V _I = 2.0V	
I _{I(OD)} (Note 5)	Bushold Input Over-Drive Current to Change State	3.0	500			μA	(Note 6)	
			-500				(Note 7)	
I _I	Input Current	3.6			10	μA	V _I = 5.5V	
		Control Pins	3.6				±1	V _I = 0V or V _{CC}
			Data Pins	3.6				-5
					1	V _I = V _{CC}		
I _{OFF}	Power Off Leakage Current	0			±100	μA	0V ≤ V _I or V _O ≤ 5.5V	
I _{PU/PD}	Power Up/Down 3-STATE Output Current	0–1.5V			±100	μA	V _O = 0.5V to 3.0V V _I = GND or V _{CC}	
I _{OZL}	3-STATE Output Leakage Current	3.6			-5	μA	V _O = 0.5V	
I _{OZH}	3-STATE Output Leakage Current	3.6			5	μA	V _O = 3.0V	

DC Electrical Characteristics (Continued)

Symbol	Parameter	V _{CC} (V)	T _A = -40°C to +85°C			Units	Conditions
			Min	Typ (Note 4)	Max		
I _{OZH} ⁺	3-STATE Output Leakage Current	3.6			10	μA	V _{CC} < V _O ≤ 5.5V
I _{CCH}	Power Supply Current	3.6			0.19	mA	Outputs High
I _{CCL}	Power Supply Current	3.6			5	mA	Outputs Low
I _{CCZ}	Power Supply Current	3.6			0.19	mA	Outputs Disabled
I _{CCZ} ⁺	Power Supply Current	3.6			0.19	mA	V _{CC} ≤ V _O ≤ 5.5V, Outputs Disabled
ΔI _{CC}	Increase in Power Supply Current (Note 8)	3.6			0.2	mA	One Input at V _{CC} - 0.6V Other Inputs at V _{CC} or GND

Note 4: All typical values are at V_{CC} = 3.3V, T_A = 25°C.

Note 5: Applies to bushold versions only (74LVTH574).

Note 6: An external driver must source at least the specified current to switch from LOW-to-HIGH.

Note 7: An external driver must sink at least the specified current to switch from HIGH-to-LOW.

Note 8: This is the increase in supply current for each input that is at the specified voltage level rather than V_{CC} or GND.

Dynamic Switching Characteristics (Note 9)

Symbol	Parameter	V _{CC} (V)	T _A = 25°C			Units	Conditions C _L = 50 pF, R _L = 500Ω
			Min	Typ	Max		
V _{OLP}	Quiet Output Maximum Dynamic V _{OL}	3.3		0.8		V	(Note 10)
V _{OLV}	Quiet Output Minimum Dynamic V _{OL}	3.3		-0.8		V	(Note 10)

Note 9: Characterized in SOIC package. Guaranteed parameter, but not tested.

Note 10: Max number of outputs defined as (n). n-1 data inputs are driven 0V to 3V. Output under test held LOW.

AC Electrical Characteristics

Symbol	Parameter	T _A = -40°C to +85°C C _L = 50 pF, R _L = 500Ω					Units
		V _{CC} = 3.3V ± 0.3V			V _{CC} = 2.7V		
		Min	Typ (Note 11)	Max	Min	Max	
f _{MAX}	Maximum Clock Frequency	150			150		MHz
t _{PHL}	Propagation Delay	1.8		4.6	1.8	5.3	ns
t _{PLH}	CP to O _n	1.8		4.5	1.8	5.3	
t _{PZL}	Output Enable Time	1.5		5.2	1.5	6.1	ns
t _{PZH}		1.5		4.8	1.5	5.9	
t _{PLZ}	Output Disable Time	2.0		4.4	2.0	4.4	ns
t _{PHZ}		2.0		4.8	2.0	5.1	
t _S	Setup Time	2.0			2.4		ns
t _H	Hold Time	0.3			0.0		ns
t _W	Pulse Width	3.3			3.3		ns
t _{OSHL}	Output to Output Skew (Note 12)			1.0		1.0	ns
t _{OSLH}				1.0		1.0	

Note 11: All typical values are at V_{CC} = 3.3V, T_A = 25°C.

Note 12: Skew is defined as the absolute value of the difference between the actual propagation delay for any two separate outputs of the same device. The specification applies to any outputs switching in the same direction, either HIGH to LOW (t_{OSHL}) or LOW to HIGH (t_{OSLH}).

Capacitance (Note 13)

Symbol	Parameter	Conditions	Typical	Units
C _{IN}	Input Capacitance	V _{CC} = Open, V _I = 0V or V _{CC}	4	pF
C _{OUT}	Output Capacitance	V _{CC} = 3.0V, V _O = 0V or V _{CC}	6	pF

Note 13: Capacitance is measured at frequency f = 1 MHz, per MIL-STD-883, Method 3012.

Physical Dimensions inches (millimeters) unless otherwise noted (Continued)

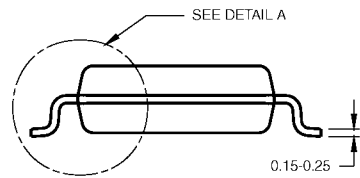

DIMENSIONS ARE IN MILLIMETERS

- NOTES:
 A. CONFORMS TO EIAJ EDR-7320 REGISTRATION, ESTABLISHED IN DECEMBER, 1998.
 B. DIMENSIONS ARE IN MILLIMETERS.
 C. DIMENSIONS ARE EXCLUSIVE OF BURRS, MOLD FLASH, AND TIE BAR EXTRUSIONS.

M20DRevB1

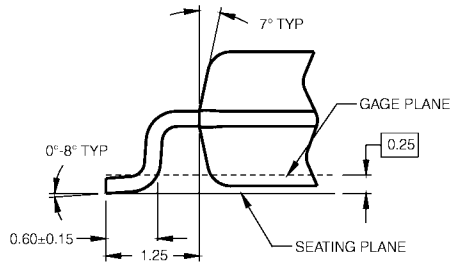

DETAIL A

Pb-Free 20-Lead Small Outline Package (SOP), EIAJ TYPE II, 5.3mm Wide Package Number M20D

Physical Dimensions inches (millimeters) unless otherwise noted (Continued)

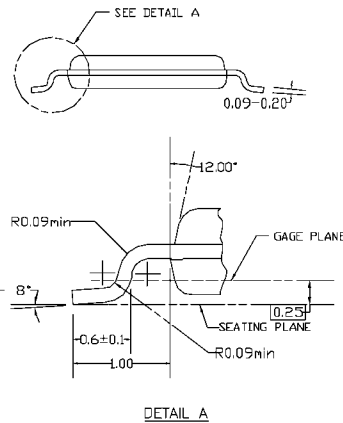
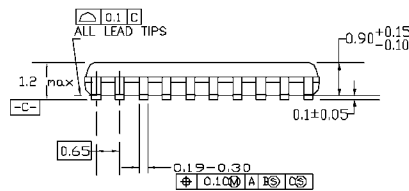
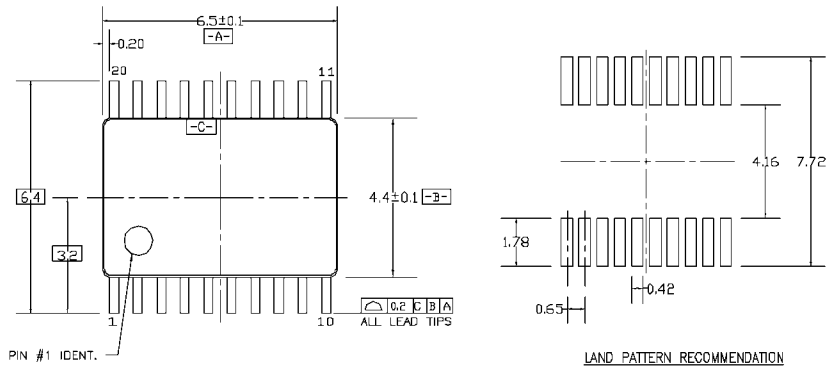

DIMENSIONS ARE IN MILLIMETERS

NOTES:

- A. CONFORMS TO JEDEC REGISTRATION MO-153, VARIATION AC, REF NOTE 6, DATE 7/93.
- B. DIMENSIONS ARE IN MILLIMETERS.
- C. DIMENSIONS ARE EXCLUSIVE OF BURRS, MOLDS FLASH, AND TIE BAR EXTRUSIONS.
- D. DIMENSIONS AND TOLERANCES PER ANSI Y14.5M, 1982.

MTC20REV D1

20-Lead Thin Shrink Small Outline Package (TSSOP), JEDEC MO-153, 4.4mm Wide Package Number MTC20

Fairchild does not assume any responsibility for use of any circuitry described, no circuit patent licenses are implied and Fairchild reserves the right at any time without notice to change said circuitry and specifications.

LIFE SUPPORT POLICY

FAIRCHILD'S PRODUCTS ARE NOT AUTHORIZED FOR USE AS CRITICAL COMPONENTS IN LIFE SUPPORT DEVICES OR SYSTEMS WITHOUT THE EXPRESS WRITTEN APPROVAL OF THE PRESIDENT OF FAIRCHILD SEMICONDUCTOR CORPORATION. As used herein:

1. Life support devices or systems are devices or systems which, (a) are intended for surgical implant into the body, or (b) support or sustain life, and (c) whose failure to perform when properly used in accordance with instructions for use provided in the labeling, can be reasonably expected to result in a significant injury to the user.
2. A critical component in any component of a life support device or system whose failure to perform can be reasonably expected to cause the failure of the life support device or system, or to affect its safety or effectiveness.

www.fairchildsemi.com