



SILICON MICROSTRUCTURES DIVISION

SM5611 Pressure DIP
SM5651 Low Pressure DIP
SM5612 Pressure DIP
SM5652 Low Pressure DIP

November 1998-2

DESCRIPTION

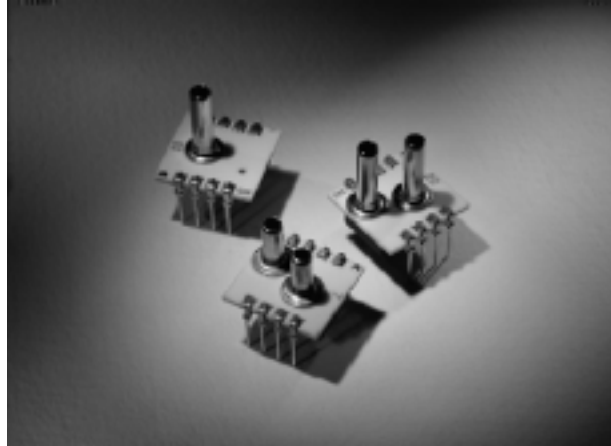
The SM5600 Series of OEM pressure sensors are fully calibrated, temperature compensated pressure sensors in dual in-line packages for printed circuit board mounting. These sensors offer improved performance as well as the option for either constant current or constant voltage excitation. Ultra-low pressure ranges are also available, resulting in the broadest selection of standard pressure ranges in the industry.

The SM5600 Series pressure sensors are constructed by attaching a highly stable piezoresistive pressure sensor chip to a ceramic substrate. Thick film resistors on the ceramic are laser trimmed during manufacturing to provide zero offset calibration, temperature compensation for zero offset, and temperature compensation for sensitivity. In the Models SM5611 and SM5651, an additional resistor is trimmed to normalize the output of an external differential amplifier to provide span calibration when the sensor is driven by a constant current supply. In the Models SM5612 and SM5652, a constant voltage supply can be used and the normalized output span of each sensor can then be easily amplified.

The Models SM5611 and SM5651 are designed for constant current excitation.

The Models SM5612 and SM5652 are designed for constant voltage excitation.

Various electrical pin and pressure port configurations are available for flexibility in matching this product to specific applications.



FEATURES

- Low Pressure (from 0-0.15 to 0-100 psi)
- Constant Voltage and Constant Current Versions
- Easy to Use Dual-in-line Package (DIP)
- Wide 0-60°C Compensated Temperature Range
- Span Calibration to $\pm 1\%$ for Standard Pressure; $\pm 2\%$ for Low Pressure
- Zero Offset Calibration
- High Performance, Stable Packaged Silicon Chip
- Gage, Differential and Absolute Pressure Configurations

APPLICATIONS

- Medical Instrumentation
- Respirators
- Air Flow Monitoring
- Process Control
- Leak Detection
- Pneumatic Controls
- Altimeters

SM5611/SM5651

SM5612/SM5652



CHARACTERISTICS

Supply Current = 1.5 mA and T = 25°C, unless otherwise specified.

Parameter	SM5611			SM5651			Units
	Min	Typ	Max	Min	Typ	Max	
Excitation Current	0	1.5	3	0	1.5	3	mA
Full Scale Output Span ¹	75	100	150	25	50	75	mV
Zero Pressure Output ²			2			2	±mV
Linearity ^{3,4}			0.1			0.3	±%FS
Pressure Hysteresis ⁴			0.1			0.3	±%FS
Input Resistance	2.2		6.0	2.2		6.0	kΩ
Output Resistance	2.5		6.0	2.5		6.0	kΩ
Temperature Coefficient -- Span ^{2,4,5}			0.5			0.65	±%FS
Temperature Coefficient -- Zero ^{2,4,5,6}			0.5			1.0	±%FS
Thermal Hysteresis -- Zero ⁵		0.1			0.1		±%FS
Supply Current		1.5	2.0		1.5	2.0	mA
Response Time (10% to 90%) ⁷		1.0			1.0		msec
Sensitivity Matching ⁸			1.0			2.0	±%
Pressure Overload ⁹			3X			3X	Rated
Operating Temperature Range	-40		125	-40		125	°C
Compensated Temperature Range	0		60	0		60	°C
Storage Temperature Range	-55		150	-55		150	°C
Media ¹⁰							
Weight		3			3		grams

Notes:

- ¹ Output span of unamplified sensor.
- ² Compensation resistors are an integral part of the sensor package; no additional external resistors are required. Pins 7 and 8 must be kept open. Models SM5611 and SM5651 are interchangeable only when used with a gain stage as shown in Figure 1.
- ³ Best Fit Straight Line (BFSL) linearity. For the 0.3 psi range of the Model SM5651, the linearity is ±0.5%FS. For the 0.15 psi range, the linearity is ±2.5%FS.
- ⁴ FS denotes full scale output.
- ⁵ Peak error measured over compensated temperature range. (Not to be confused with RMS error method as specified on SM555X product). For 0.3 psi range, TC span is ±0.75%FS. For the 0.15 psi range, TC span is ±2.0%FS.
- ⁶ For 0.15 psi range, TC-zero is ±2.5%FS.
- ⁷ For a zero-to-full scale pressure step change.
- ⁸ Sensitivity matching relates to the interchangeability of the span when used with the gain set resistor in the circuit shown in Figure 1. The specification applies to the accuracy of the thick film resistor where $GSR = \text{Gain Set Resistor } R_s = \text{Span} * 200,000 / (3.012 * \text{Span})$. For all ranges except 0.15 psi range of the Model SM5651, the sensitivity matching is ±2.0%. For 0.15 psi range, the sensitivity matching is ±5.0%FS.
- ⁹ For Model SM5611: 3X or 225 psi, whichever is less. For Model SM5651: 3X or 5 psi, whichever is greater.
- ¹⁰ Clean, dry gasses, compatible with wetted materials. Wetted materials include Pyrex glass, silicon, alumina ceramic, epoxy, RTV, gold, aluminum, and nickel.

CHARACTERISTICS

Supply Voltage = 10.0 VDC and T = 25°C, unless otherwise specified.

Parameter	SM5612			SM5652			Units
	Min	Typ	Max	Min	Typ	Max	
Excitation Voltage	0	10	20	0	10	20	V
Full Scale Output Span ¹	39.5	40.0	40.5	24.5	25.0	25.5	mV
Zero Pressure Output ²			2			2	±mV
Linearity ^{3,4}			0.1			0.3	±%FS
Pressure Hysteresis ⁴			0.1			0.3	±%FS
Input Resistance	4		26	4		26	kΩ
Output Resistance	2.2		6.0	2.2		6.0	kΩ
Temperature Coefficient -- Span ^{2,4,5}			0.5			0.65	±%FS
Temperature Coefficient -- Zero ^{2,4,5,6}			0.5			1.0	±%FS
Thermal Hysteresis -- Zero ⁵		0.1			0.1		±%FS
Response Time (10% to 90%) ⁷		1.0			1.0		msec
Pressure Overload ⁸			3X			3X	Rated
Operating Temperature Range	-40		125	-40		125	°C
Compensated Temperature Range	0		60	0		60	°C
Storage Temperature Range	-55		150	-55		150	°C
Media ¹⁰							
Weight		3			3		grams

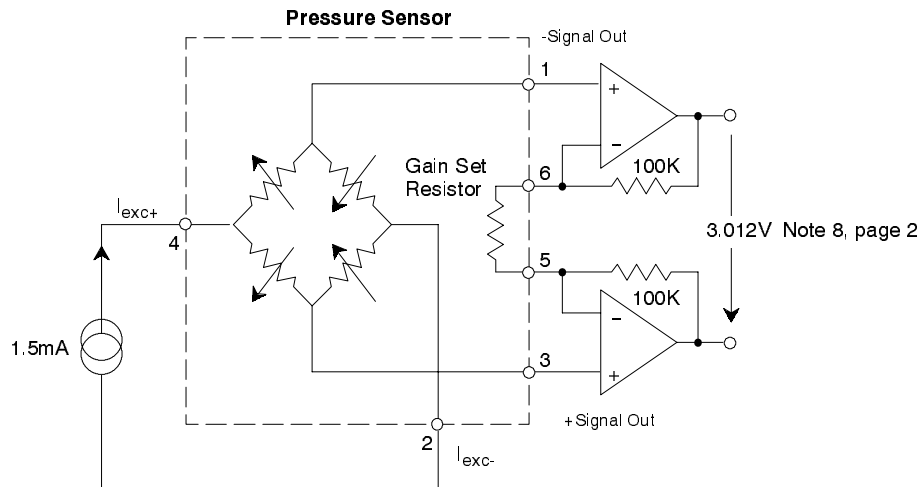
Notes:

- ¹ Output span of unamplified sensor.
- ² Compensation resistors are an integral part of the sensor package; no additional external resistors are required. Pins 7 and 8 must be kept open. Models SM5611 and SM5651 are interchangeable only when used with a gain stage as shown in Figure 1.
- ³ Best Fit Straight Line (BFSL) linearity. For the 0.3 psi range of the Model SM5652, the linearity is ±0.5%FS. For the 0.15 psi range, the linearity is ±2.5%FS.
- ⁴ FS denotes full scale output.
- ⁵ Peak error measured over compensated temperature range. (Not to be confused with RMS error method as specified on SM555X product). For 0.3 psi range, TC span is ±0.75%FS. For the 0.15 psi range, TC span is ±2.0%FS.
- ⁶ For 0.15 psi range, TC-zero is ±2.5%FS.
- ⁷ For a zero-to-full scale pressure step change.
- ⁸ For Model SM5611: 3X or 225 psi, whichever is less. For Model SM5651: 3X or 5 psi, whichever is greater.
- ⁹ Clean, dry gasses, compatible with wetted materials. Wetted materials include Pyrex glass, silicon, alumina ceramic, epoxy, RTV, gold, aluminum, and nickel.

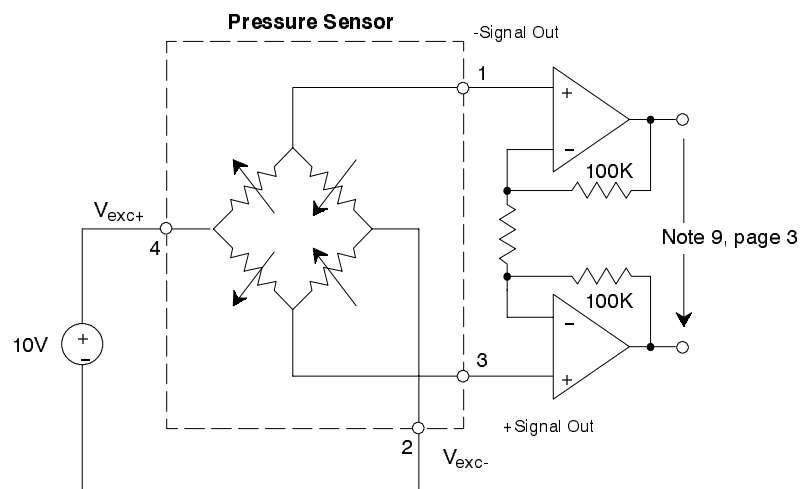
SM5611/SM5651 SM5612/SM5652



Device Pinouts Differential Gain Configurations

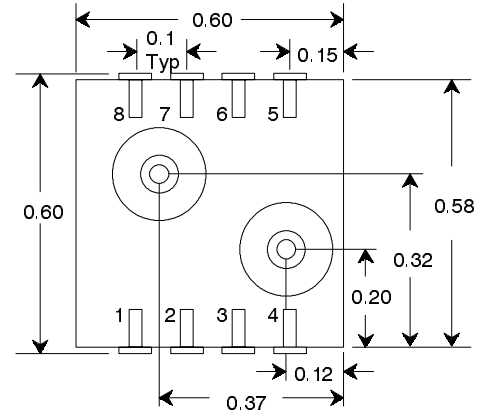
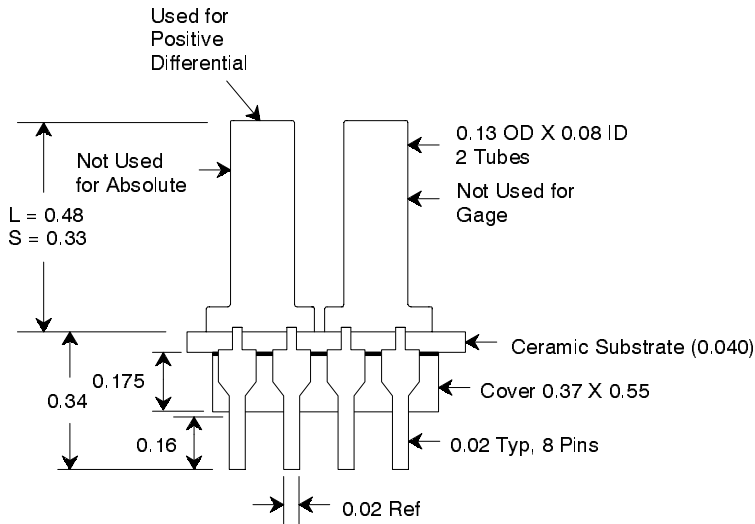


**Figure 1. SM5611 and SM5651
with Constant Current Supply and Differential Output**



**Figure 2. SM5612 and SM5652
with Constant Voltage Supply and Differential Output**

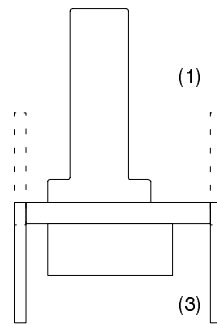
DIMENSIONS



Model SM5612 and SM5652

Pin

1. -Signal Out
2. $-V_{exc}$
3. +Signal Out
4. $+V_{exc}$
5. N/C
6. N/C
7. N/C
8. N/C



(1), (3) Pin Configuration

Model SM5611 and SM5651

Pin

1. -Signal Out
2. $-I_{exc}$
3. +Signal Out
4. $+I_{exc}$
5. Gain Set Resistor
6. Gain Set Resistor
7. N/C
8. N/C

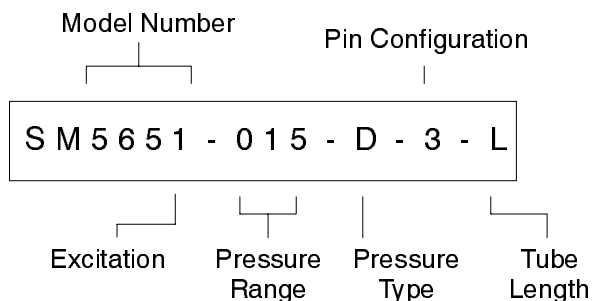
Notes:

- Soldering of lead pins: 250°C for 5 seconds maximum.
- All dimensions are in inches.

SM5611/SM5651 SM5612/SM5652



ORDERING INFORMATION



Excitation

- 1: Current
- 2: Voltage

Pin Configuration

- 1: Pins same direction as tube
- 3: Pins opposite direction of tube

Tube Length

- L: Long (0.480" ±0.005)
- S: Short (0.330" ±0.005)
- N: No Tube

Pressure Type

- A: Absolute (1 Tube) (Models SM6511 and SM5612 only)
- D: Differential (2 Tubes)
- G: Gage (1 Tube)

Standard Pressure Range Model SM5611 and SM5612

Ord. Info	psi	BAR	kPa	Hg ¹ (mm)	H ₂ O ² (Inches)	H ₂ O ³ (mm)
005	5	0.345	34.47	258.6	138.4	3515.4
015	15	1.034	103.42	775.7	415.2	10546.1
030	30	2.068	206.84	1551.5	830.4	21092.2
060	60	4.137	413.68	3102.9	1660.8	42184.3
100	100	6.895	689.47	5171.5	2768	70307.2

- ¹ At 0° C
- ² At 39° F
- ³ At 4° C

Low Pressure Range Model SM5651 and SM5652

Ord. Info	psi	BAR	kPa	Hg ¹ (mm)	H ₂ O ² (Inches)	H ₂ O ³ (mm)
001	0.15	0.010	1.03	7.8	4.152	105.5
003	0.3	0.021	2.07	15.5	8.304	210.9
008	0.8	0.055	5.52	41.4	22.144	562.5
015	1.5	0.103	10.34	77.6	41.52	1024.6
030	3.0	0.207	20.68	155.1	83.04	2109.2

- ¹ At 0° C
- ² At 39° F
- ³ At 4° C

Note:
-Low pressure devices are not available as absolute sensors.

Special Configurations are available. Contact EXAR Corporation for more information.

Notes

NOTICE

EXAR Corporation reserves the right to make changes to the products contained in this publication in order to improve design, performance or reliability. EXAR Corporation assumes no responsibility for the use of any circuits described herein, conveys no license under any patent or other right, and makes no representation that the circuits are free of patent infringement. Charts and schedules contained herein are only for illustration purposes and may vary depending upon a user's specific application. While the information in this publication has been carefully checked; no responsibility, however, is assumed for inaccuracies.

EXAR Corporation does not recommend the use of any of its products in life support applications where the failure or malfunction of the product can reasonably be expected to cause failure of the life support system or to significantly affect its safety or effectiveness. Products are not authorized for use in such applications unless EXAR Corporation receives, in writing, assurances to its satisfaction that: (a) the risk of injury or damage has been minimized; (b) the user assumes all such risks; (c) potential liability of EXAR Corporation is adequately protected under the circumstances.

Copyright 1998 EXAR Corporation Silicon Microstructures Division
Datasheet November 1998

Reproduction, in part or whole, without the prior written consent of EXAR Corporation is prohibited.