



Technical Data Sheet

3.9*3.3mm Elliptical Wide Angle LED Lamps

4244-11UYC/S400-A6

■ Features :

- Choice of various viewing angles
- Available on tape and reel.
- Reliable and robust
- Pb free



■ Descriptions :

- The series is specially designed for applications requiring higher brightness
- The led lamps are available with different colors, intensities,

■ Applications :

- TV set
- Monitor
- Telephone
- Computer

PART NO.	Material	Emitted Color	Lens Color
4244-11UYC/S400-A6	AlGaInP	Super Yellow	Water Clear



Technical Data Sheet

3.9*3.3mm Elliptical Wide Angle LED Lamps

4244-11UYC/S400-A6

Package Dimensions

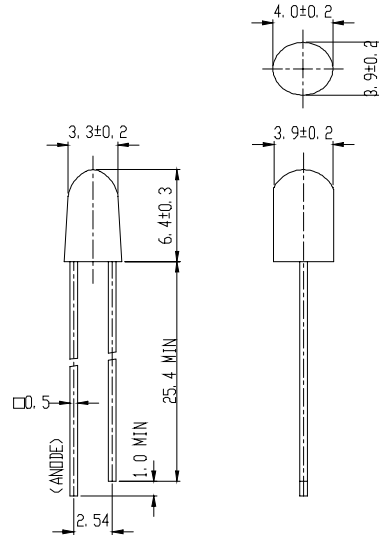

Notes: 1. All dimensions are in millimetres

2. An epoxy meniscus may extend about 1.5mm(0.059") down to the lead.

3. Tolerances unless Dimension ± 0.25 mm.

Absolute Maximum Ratings at $T_a = 25^\circ\text{C}$

Parameter	Symbol	Rating	Unit
Forward Current	I_F	50	mA
Operating Temperature	T_{opr}	-40 to +85	$^\circ\text{C}$
Storage Temperature	T_{stg}	-40 to +100	$^\circ\text{C}$
Electrostatic Discharge	ESD	2000	V
Soldering Temperature	T_{sol}	260 ± 5	$^\circ\text{C}$
Power Dissipation	P_d	120	mW
Peak Forward Current	$I_F(\text{Peak})$	200	mA
Reverse Voltage	V_R	5	V

Note: *1: I_F Conditions --Pulse Width $\leq 1\text{msec}$ and Duty $\leq 1/10$.

*2:Soldering time ≤ 5 seconds.



Technical Data Sheet

3.9*3.3mm Elliptical Wide Angle LED Lamps

4244-11UYC/S400-A6

Electro-Optical Characteristics (Ta=25°C)

Parameter	Symbol	Condition	Min.	Typ.	Max.	Unit
Forward Voltage	V _F	IF= 20 mA	/	2.0	2.4	V
Reverse Current	I _R	VR= 5 V	/	/	50	μA
Luminous Intensity	I _v	IF= 20 mA	130	210	/	mcd
Viewing Angle	2θ 1/2	IF= 20 mA	/	(X)35 (Y)80	/	deg
Peak Wavelength	λ _p	IF= 20 mA	/	591	/	nm
Dominant Wavelength	λ _d	IF= 20 mA	/	589	/	nm
Spectrum Radiation Bandwidth	Δλ	IF= 20 mA	/	15	/	nm



Technical Data Sheet

3.9*3.3mm Elliptical Wide Angle LED Lamps

4244-11UYC/S400-A6

Typical Electro-Optical Characteristic Curves:

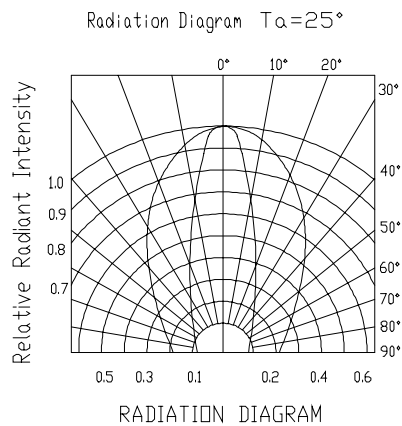
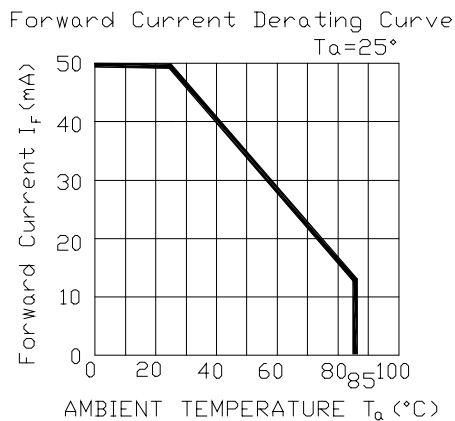
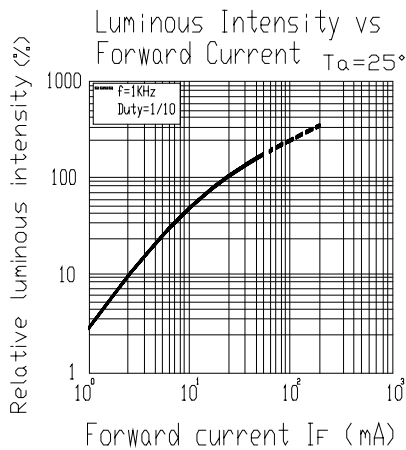
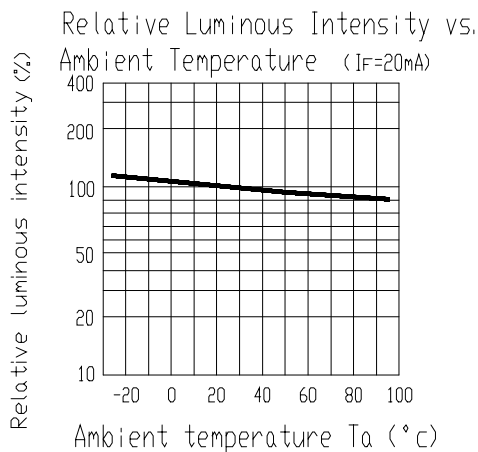
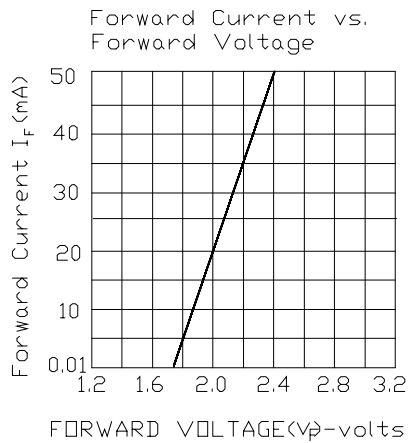
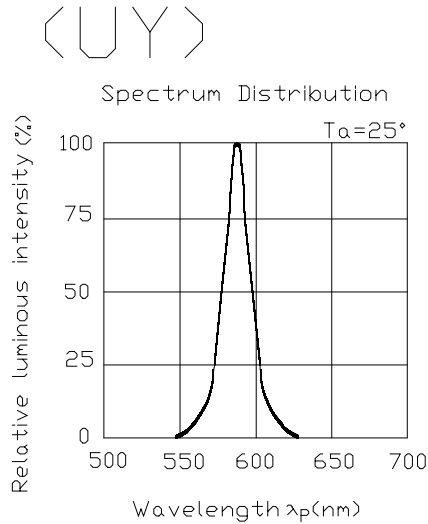



Technical Data Sheet

3.9*3.3mm Elliptical Wide Angle LED Lamps

4244-11UYC/S400-A6

■ Reliability test items and conditions:

NO	Item	Test Conditions	Test Hours/Cycle	Sample size	Ac/Re
1	Solder Heat	TEMP : 260°C ± 5 °C	10 SEC	76 PCS	0/1
2	Temperature Cycle	H : +100°C 15min ∫ 5 min L : -40°C 15min	300 CYCLES	76 PCS	0/1
3	Thermal Shock	H : +100°C 5min ∫ 10 sec L : -10°C 5min	300 CYCLES	76 PCS	0/1
4	High Temperature Storage	TEMP : 100°C	1000 HRS	76 PCS	0/1
5	Low Temperature Storage	TEMP : -40°C	1000 HRS	76 PCS	0/1
6	DC Operating Life	TEMP : 25°C IF = 20mA	1000 HRS	76 PCS	0/1
7	High Temperature / High Humidity	85°C / 85% RH	1000 HRS	76 PCS	0/1



Technical Data Sheet

3.9*3.3mm Elliptical Wide Angle LED Lamps

4244-11UYC/S400-A6

Packing Quantity Specification

1.500PCS/1Bag , 5Bags/1Box

2.10Boxes/1Carton

Label Form Specification

EVERLIGHT

CPN:

P/N:



4244-11UYC/S400-A6

QTY:

CAT:



HUE:

REF:

LOT NO: EL



MADE IN TAIWAN

CPN: Customer's Production Number

P/N : Production Number

QTY: Packing Quantity

CAT: Ranks

HUE: Peak Wavelength

REF: Reference

LOT No: Lot Number

MADE IN TAIWAN: Production Place

Notes

1. Above specification may be changed without notice. EVERLIGHT will reserve authority on material change for above specification.
2. When using this product, please observe the absolute maximum ratings and the instructions for using outlined in these specification sheets. EVERLIGHT assumes no responsibility for any damage resulting from use of the product which does not comply with the absolute maximum ratings and the instructions included in these specification sheets.
3. These specification sheets include materials protected under copyright of EVERLIGHT corporation. Please don't reproduce or cause anyone to reproduce them without EVERLIGHT's consent.

EVERLIGHT ELECTRONICS CO., LTD.

Office: No 25, Lane 76, Sec 3, Chung Yang Rd,
Tucheng, Taipei 236, Taiwan, R.O.C

Tel: 886-2-2267-2000, 2267-9936

Fax: 886-2267-6244, 2267-6189, 2267-6306
<http://www.everlight.com>