



# EVERLIGHT ELECTRONICS CO.,LTD.

Device Number : DLE-100-010 REV.: 1.1

3.68\*6.22mm Rectangular Legend LED Lamps

PART NO. : 1003YD-R ECN : \_\_\_\_\_ Page: 1/4

## ■ Features :

- Choice of various viewing angles
- Available on tape and reel.
- Reliable and robust

## ■ Descriptions :

- The series is specially designed for applications requiring higher brightness
- The led lamps are available with different colors, intensities, epoxy colors, etc.

## ■ Applications :

- TV set
- Monitor
- Telephone
- Computer

## ■ Package Dimensions:

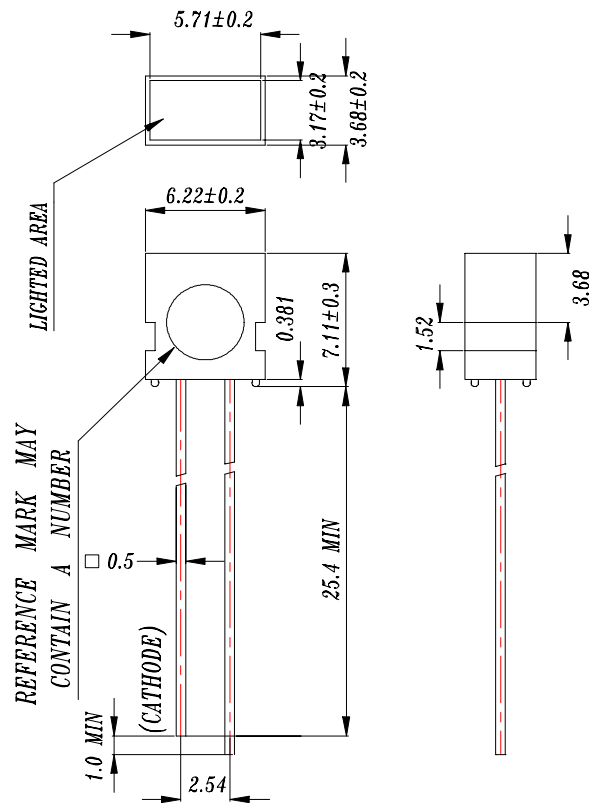

## ■ Notes :

1. All dimensions are in millimeters.
2. An epoxy meniscus may extend about 1.5mm(0.059") down to the lead.
3. Tolerances unless dimension  $\pm 0.25$ mm.

PART NO.	Chip		Lens Color
	Material	Emitted Color	
1003YD-R	GaAsP/GaP	Yellow	Yellow Diffused

OFFICE : NO. 25,Lane 76,Sec.3, Chung Yang Rd., Tucheng 236, Taipei, Taiwan, R.O.C.

TEL. : 886-2-2267-2000,2267-9936

FAX : 886-2-2267-6244,22676189,22676306

<http://www.everlight.com>

B98667,980691



# EVERLIGHT ELECTRONICS CO.,LTD.

Device Number : DLE-100-010 REV.: 1.1

3.68\*6.22mm Rectangular Legend LED Lamps

PART NO. : 1003YD-R

ECN :          Page: 2/4

## ■ Absolute Maximum Ratings at Ta = 25°C

Parameter	Symbol	Rating	Unit
Forward Current	IF	25	mA
Operating Temperature	Topr	-40 to +85	°C
Storage Temperature	Tstg	-40 to +100	°C
Soldering Temperature	Tsol	260 ± 5	°C
Power Dissipation	Pd	85	mW
Peak Forward Current(Duty 1/10 @ 1KHz)	IF(Peak)	160	mA
Reverse Voltage	VR	5	V

## ■ Electronic Optical Characteristics :

Parameter	Symbol	Min.	Typ.	Max.	Unit	Condition
Luminous Intensity	Iv	1.0	4.0	/	mcd	IF= 10 mA
Viewing Angle	2θ 1/2	/	100	/	deg	IF= 20 mA
Peak Wavelength	λ p	/	585	/	nm	IF= 20 mA
Dominant Wavelength	λ d	/	590	/	nm	IF= 20 mA
Spectrum Radiation Bandwidth	Δ λ	/	35	/	nm	IF= 20 mA
Forward Voltage	VF	1.7	2.0	2.4	V	IF= 20 mA
Reverse Current	IR	/	/	10	μ A	VR= 5 V



# EVERLIGHT ELECTRONICS CO.,LTD.

Device Number : DLE-100-010 REV.: 1.1

3.68\*6.22mm Rectangular Legend LED Lamps

PART NO. : 1003YD-R ECN :                      Page: 3/4

## ■ Typical Electro-Optical Characteristic Curves:

( Y )

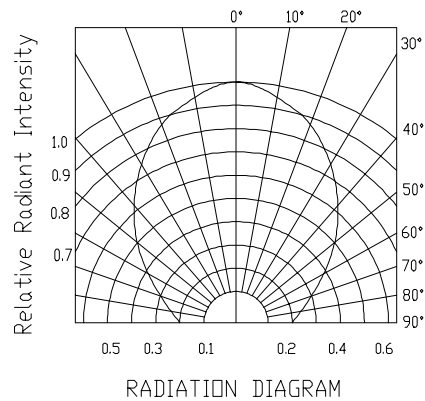
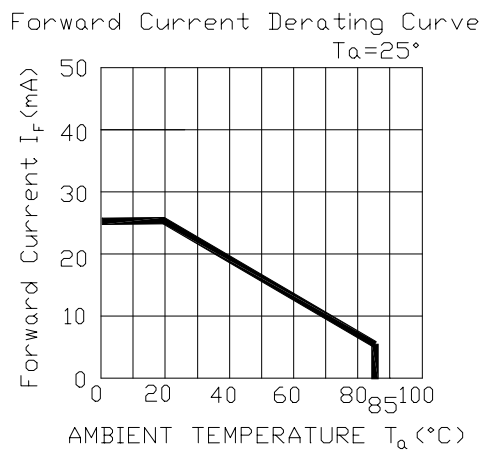
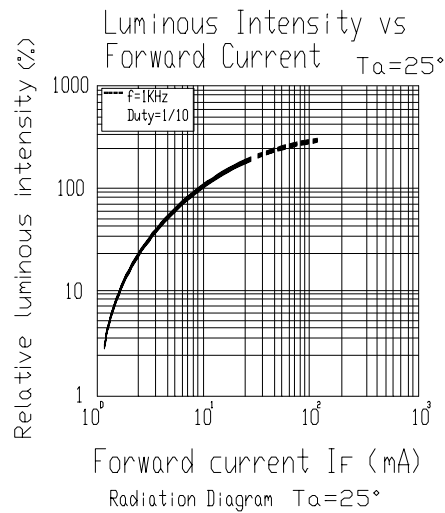
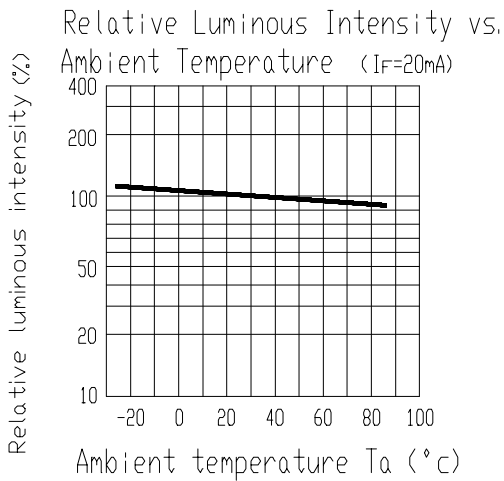
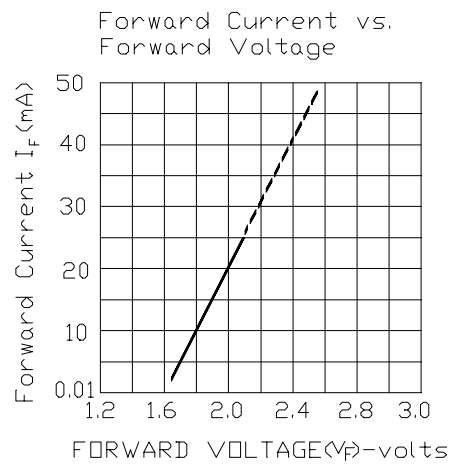
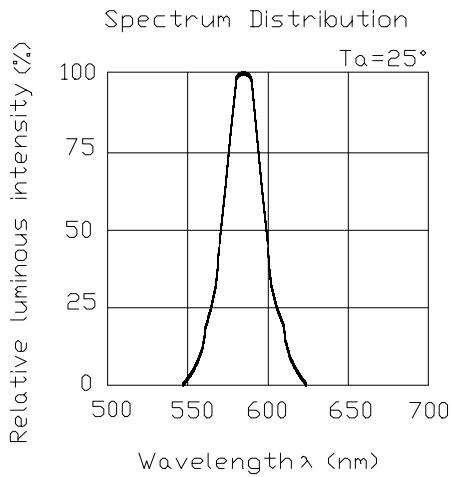



# EVERLIGHT ELECTRONICS CO.,LTD.

Device Number : DLE-100-010 REV.: 1.1

3.68\*6.22mm Rectangular Legend LED Lamps

PART NO. : 1003YD-R ECN : \_\_\_\_\_ Page: 4/4

## ■ Reliability test items and conditions:

No	Item	Test Conditions	Test Hours/Cycle	Sample Size	Ac/Re
1	Solder Heat	TEMP : 260°C ± 5 °C	5 SEC	76 PCS	0/1
2	Temperature Cycle	H : +85°C 30min § 5 min L : -55°C 30min	50 CYCLES	76 PCS	0/1
3	Thermal Shock	H : +100°C 5min § 10 sec L : -10°C 5min	50 CYCLES	76 PCS	0/1
4	High Temperature Storage	TEMP : 100°C	1000 HRS	76 PCS	0/1
5	Low Temperature Storage	TEMP : -55°C	1000 HRS	76 PCS	0/1
6	DC Operating Life	IF = 20 mA	1000 HRS	76 PCS	0/1
7	High Temperature / High Humidity	85°C /85% RH	1000 HRS	76 PCS	0/1