



### Features:

Volle Sperrfähigkeit bei  $T_{vj}=125^{\circ}\text{C}$  mit 50 Hz

Full blocking capability at  $T_{vj}=125^{\circ}\text{C}$  with 50 Hz

Hohe Stoßströme und niedriger Wärme-widererstand durch NTV-Verbindung zwischen Silizium und Mo-Trägerscheibe.

High surge currents and low thermal resistance by using low temperature-connection NTV between silicon wafer and molybdenum.

Elektroaktive Passivierung durch a - C:H

Electroactive passivation by a - C:H

### Elektrische Eigenschaften / Electrical properties

Höchstzulässige Werte / Maximum rated values

Periodische Vorwärts - und Rückwärts - Spitzensperrspannung repetitive peak forward off-state and reverse voltage	f = 50 Hz	$V_{DRM}$ , $V_{RRM}$	$T_{vjmin}=-40^{\circ}\text{C}$ , $T_{vjmin}=0^{\circ}\text{C}$	
			2800      2900	V
			3200      3300	V
			3400      3500	V
			3500      3600	V
			3600      3700	V
Durchlaßstrom-Grenzeffektivwert RMS forward current		$I_{TRMSM}$	2050	A
Dauergrenzstrom average on-state current	$T_c = 85^{\circ}\text{C}$ , f = 50Hz $T_c = 60^{\circ}\text{C}$ , f = 50Hz	$I_{TAVM}$	950 1300	A A
Stoßstrom-Grenzwert surge forward current	$T_{vj} = 25^{\circ}\text{C}$ , $t_p = 10\text{ms}$ , $V_R = 0$ $T_{vj} = T_{vj\text{max}}$ , $t_p = 10\text{ms}$ , $V_R = 0$	$I_{TSM}$	19 17	kA kA
Grenzlastintegral $I^2t$ -value	$T_{vj} = 25^{\circ}\text{C}$ , $t_p = 10\text{ms}$ $T_{vj} = T_{vj\text{max}}$ , $t_p = 10\text{ms}$	$I^2t$	$1,805 \cdot 10^6$ $1,445 \cdot 10^6$	$\text{A}^2\text{s}$ $\text{A}^2\text{s}$
Kritische Stromsteilheit critical rate of rise of on-state current	DIN IEC 747-6 f = 50Hz, $i_{GM} = 1\text{A}$ , $di_g/dt = 1\text{A}/\mu\text{s}$	$(di/dt)_{cr}$	80	A/ $\mu\text{s}$
Kritische Spannungssteilheit critical rate of rise of off-state voltage	$T_{vj} = T_{vj\text{max}}$ , $V_D = 0,67 V_{DRM}$ 5. Kennbuchstabe / 5 th letter F	$(dv/dt)_{cr}$	1000	V/ $\mu\text{s}$

# Technische Information / Technical Information

**eupec**

Netz Thyristor  
Phase Control Thyristor

**T 901N 28...36TOF**

**N**



## Elektrische Eigenschaften / Electrical properties

### Charakteristische Werte / Characteristic values

Durchlaßspannung on-state voltage	$T_{vj} = T_{vj\ max}, i_T = 1,2\ kA$	$v_T$	typ 1,5	max 1,75	V
Schleusenspannung / threshold voltage Ersatzwiderstand / slope resistance	$T_{vj} = T_{vj\ max}$	$V_{(TO)}$ $r_T$	typ 1	max 1,16	V mΩ
Durchlaßrechenkennlinien On - state characteristics for calculation $V_T = A + B \cdot i_T + C \cdot \ln(i_T+1) + D \cdot \sqrt{i_T}$ 300 A ≤ $i_T$ ≤ 5000 A	$T_{vj} = T_{vj\ max}$	A B C D	typ -0,0764 0,00032 0,165 0,000816	max - 0,0802 0,00045 0,2085 -0,00524	
Zündstrom gate trigger current	$T_{vj} = 25^\circ C, v_D = 6V$	$I_{GT}$	max	350	mA
Zündspannung gate trigger voltage	$T_{vj} = 25^\circ C, v_D = 6V$	$V_{GT}$	max	2,5	V
Nicht zündender Steuerstrom gate non-trigger current	$T_{vj} = T_{vj\ max}, v_D = 6V$ $T_{vj} = T_{vj\ max}, v_D = 0,5 V_{DRM}$	$I_{GD}$		20 10	mA mA
Nicht zündende Steuerspannung gate non-trigger voltage	$T_{vj} = 25^\circ C, v_D = 0,5 V_{DRM}$	$V_{GD}$		0,4	V
Haltestrom holding current	$T_{vj} = 25^\circ C, v_D = 12V, R_A = 4,7\ \Omega$	$I_H$		300	mA
Einraststrom latching current	$T_{vj} = 25^\circ C, v_D = 12V, R_{GK} \geq 10\ \Omega$ $i_{GM} = 1A, di_G/dt = 1\ A/\mu s, t_g = 20\ \mu s$	$I_L$		3	A
Vorwärts- und Rückwärts-Sperrstrom forward off-state and reverse current	$T_{vj} = T_{vj\ max}$ $v_D = V_{DRM}, v_R = V_{RRM}$	$i_D, i_R$		100	mA
Zündverzug gate controlled delay time	DIN IEC 747-6 $T_{vj} = 25^\circ C,$ $i_{GM} = 1A, di_G/dt = 1A/\mu s$	$t_{gd}$		2	μs
Freiwerdezeit circuit commutated turn-off time	$T_{vj} = T_{vj\ max}, i_{TM} = I_{TAVM}$ $v_{RM} = 100V, v_{DM} = 0,67 V_{DRM}$ $dv_D/dt = 20V/\mu s, di_T/dt = -10A/\mu s$ 4. Kennbuchstabe / 4 th letter O	$t_q$	typ	300	μs
Sperrverzögerungsladung recovered charge	$T_{vj} = T_{vj\ max}$ $i_{TM} = 2\ kA, di/dt = -10\ A/\mu s$ $v_R = 0,5 V_{RRM}, v_{RM} = 0,8 V_{RRM}$	$Q_r$	max.	7,5	mAs
Rückstromspitze peak reverse recovery current	$T_{vj} = T_{vj\ max}$ $i_{TM} = 2\ kA, di/dt = -10\ A/\mu s$ $v_R = 0,5 V_{RRM}, v_{RM} = 0,8 V_{RRM}$	$I_{RM}$		220	A

# Technische Information / Technical Information

**eupec**

Netz Thyristor  
Phase Control Thyristor

**T 901N 28...36TOF**

**N**

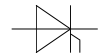

## Thermische Eigenschaften / Thermal properties

Innerer Wärmewiderstand thermal resistance, junction to case	beidseitig / two-sided, $\theta = 180^\circ \sin$ beidseitig / two-sided, DC	$R_{thJC}$	0,018 0,017	$^\circ\text{C/W}$ $^\circ\text{C/W}$
Übergangs-Wärmewiderstand thermal resistance, case to heatsink	beidseitig / two-sided	$R_{thCK}$	0,004	$^\circ\text{C/W}$
Höchstzulässige Sperrschichttemperatur max. junction temperature		$T_{vj \max}$	125	$^\circ\text{C}$
Betriebstemperatur operating temperature		$T_{c \text{ op}}$	-40...+125	$^\circ\text{C}$
Lagertemperatur storage temperature		$T_{stg}$	-40...+150	$^\circ\text{C}$

## Mechanische Eigenschaften / Mechanical properties

Gehäuse, siehe Anlage case, see appendix			Seite 4	
Si-Element mit Druckkontakt, Amplifying-Gate Si-pellet with pressure contact, amplifying gate			55TN36	
Anpreßkraft clampig force		F	15...24	kN
Gewicht weight		G	typ 550	g
Kriechstrecke creepage distance			25	mm
Feuchteklasse humidity classification	DIN 40040		C	
Schwingfestigkeit vibration resistance	f = 50Hz		50	$\text{m/s}^2$

Mit dieser technischen Information werden Halbleiterbauelemente spezifiziert, jedoch keine Eigenschaften zugesichert. Sie gilt in Verbindung mit den zugehörigen technischen Erläuterungen.  
This technical information specifies semiconductor devices but promises no characteristics. It is valid in combination with the belonging technical notes.



Maßbild / Outline

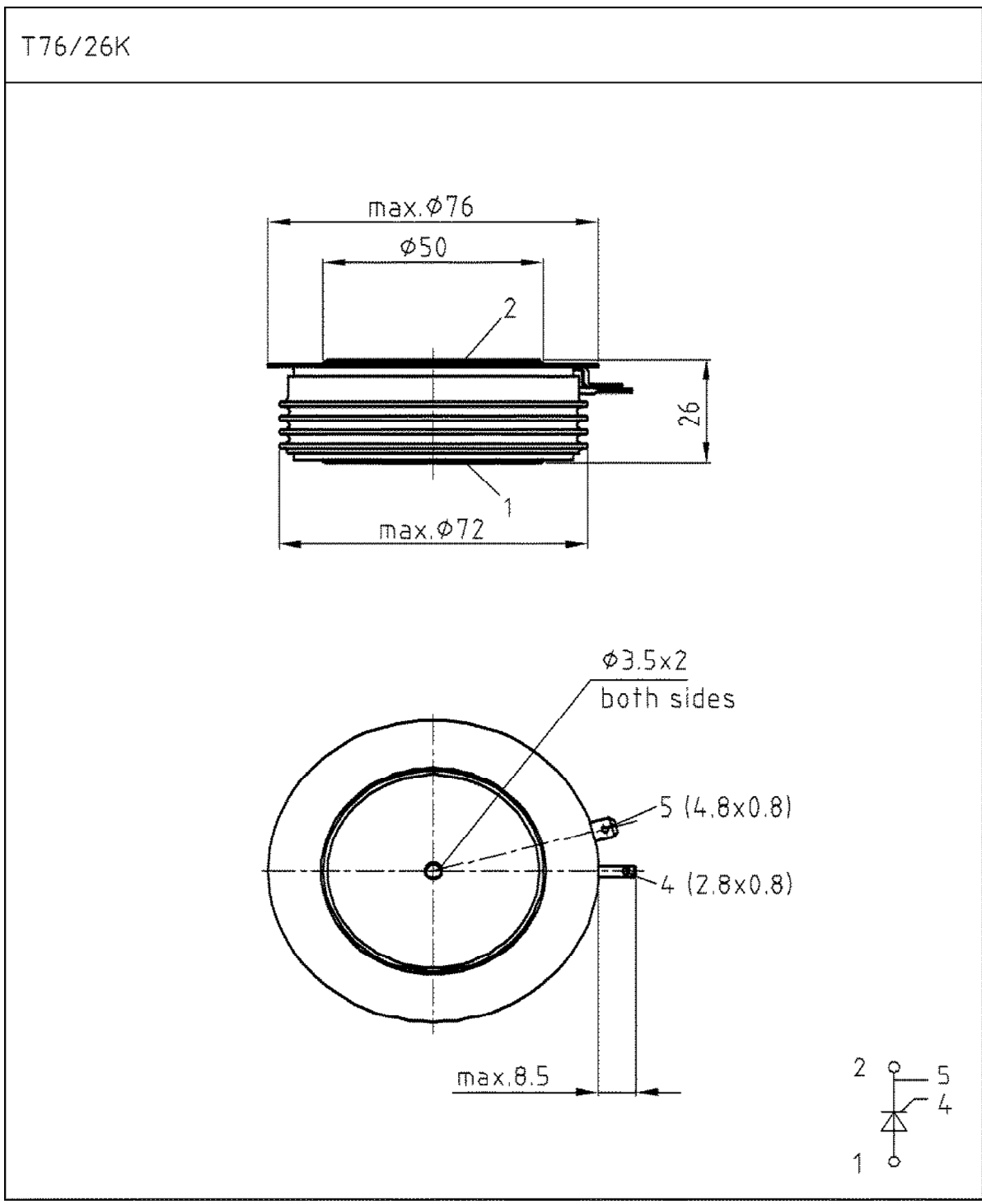



**Durchlaßkennlinien  $i_T = f(v_T)$**   
Limiting and typical on-state characteristic

—  $T_{vj} = 125^\circ\text{C}$

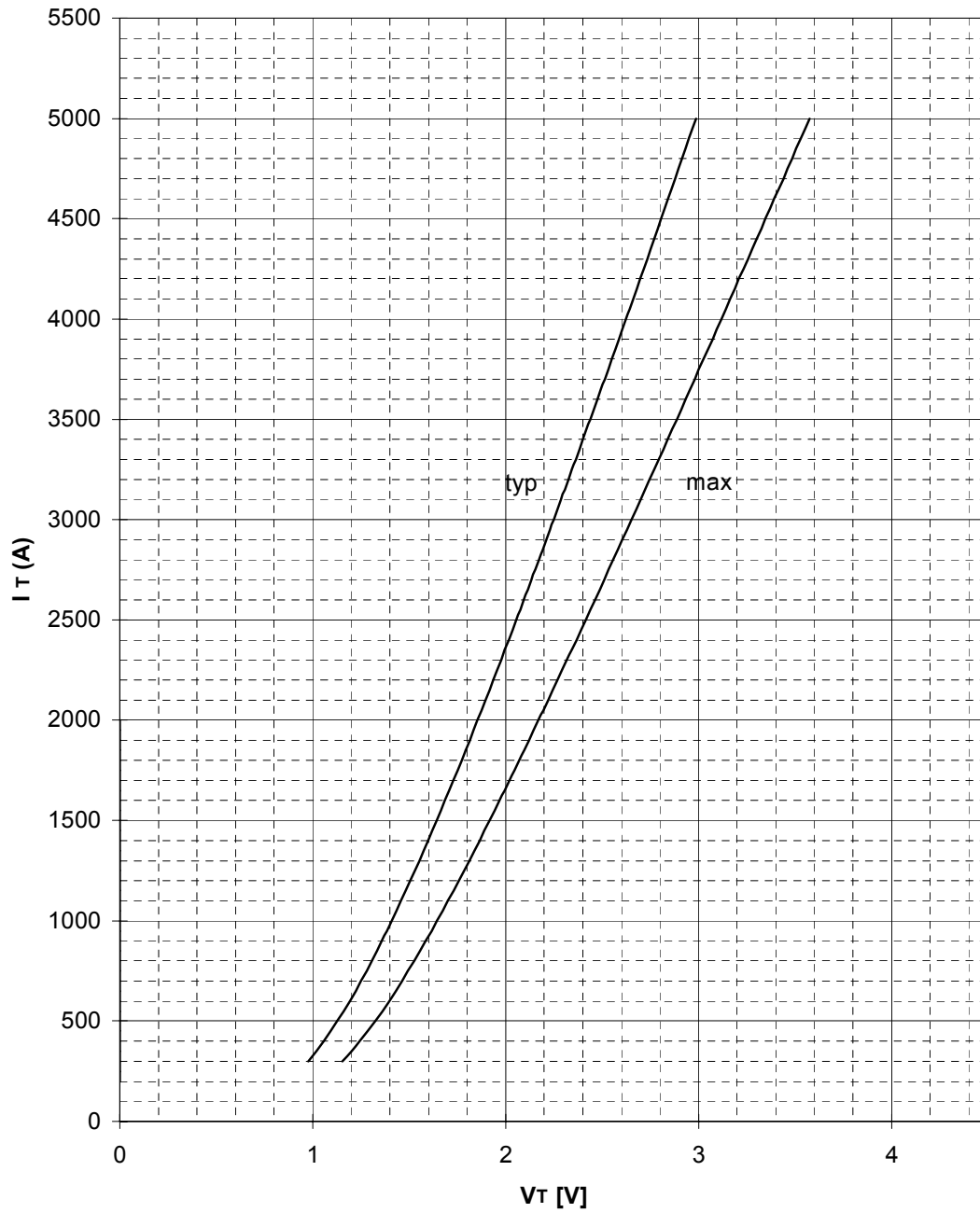

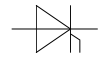

**Steuerkreischarakteristik mit Zündbereichen**  
**Gate characteristic with triggering areas**

$v_G = f(i_G), V_D = 6V$

Parameter		a	b	c
Steuerimpulsdauer / trigger pulse duration	$t_G(\text{ms})$	10	1	0.5
Höchstzulässige Spitzensteuerverlustleistung	Max. rated peak power dissipation	$P_{GM}(\text{W})$	20	40
			40	60

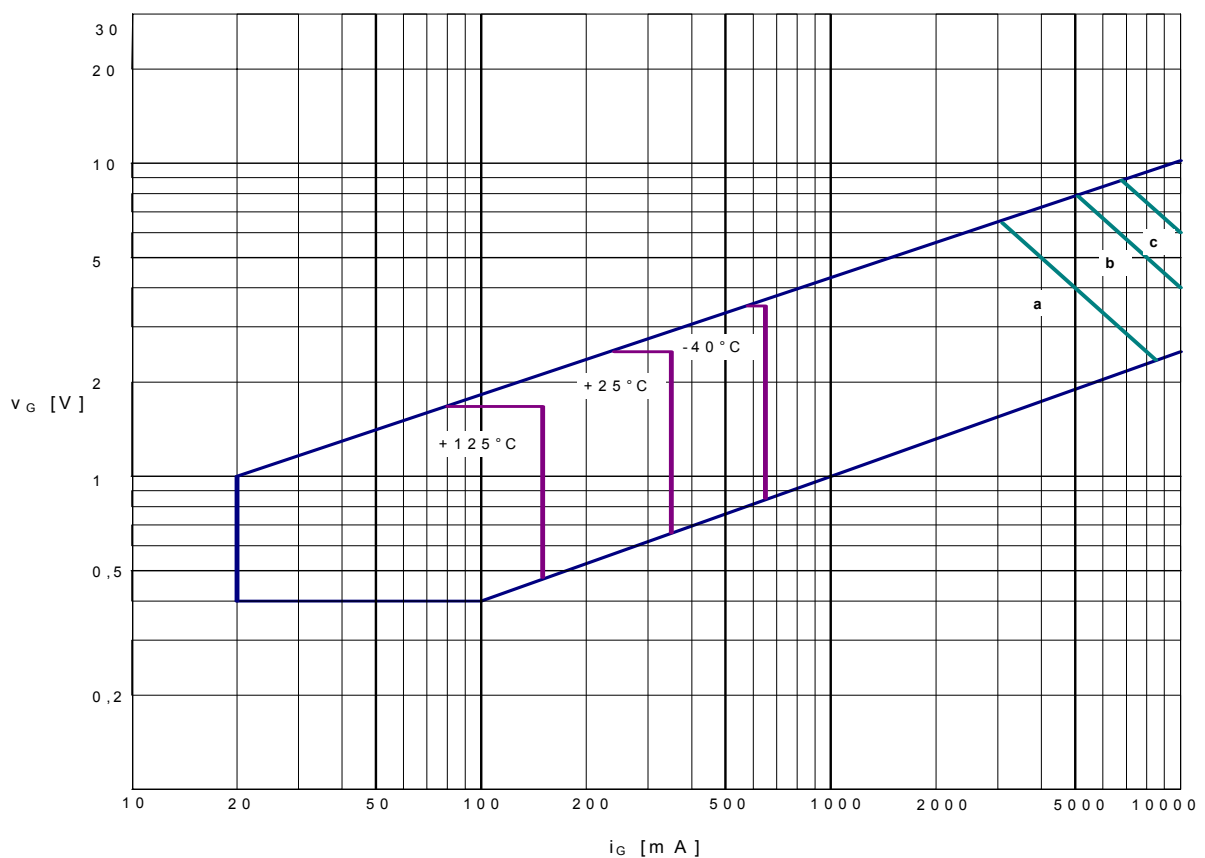



**Transienter innerer Wärmewiderstand  
Transient thermal impedance  $Z_{thJC} = f(t)$**

$$Z_{thJC} = \sum_{n=1}^{n_{max}} R_{thn} \cdot (1 - e^{-t/\tau_n})$$

n	double-sided cooling		cathode-side cooling		anode-side cooling	
	$R_{th}$ [K/W]	$\tau_n$ [s]	$R_{th}$ [K/W]	$\tau_n$ [s]	$R_{th}$ [K/W]	$\tau_n$ [s]
1	0,00554	1,13	0,02271	6,03	0,02071	5,8
2	0,00029	0,805	0,0089	0,15	0,0089	0,15
3	0,0081	0,129	0,00032	0,0934	0,00032	0,0934
4	0,002	0,0145	0,002	0,0145	0,002	0,0145
5	0,00107	0,004	0,00107	0,004	0,00107	0,004
$\Sigma$	0,01700		0,0350		0,0330	

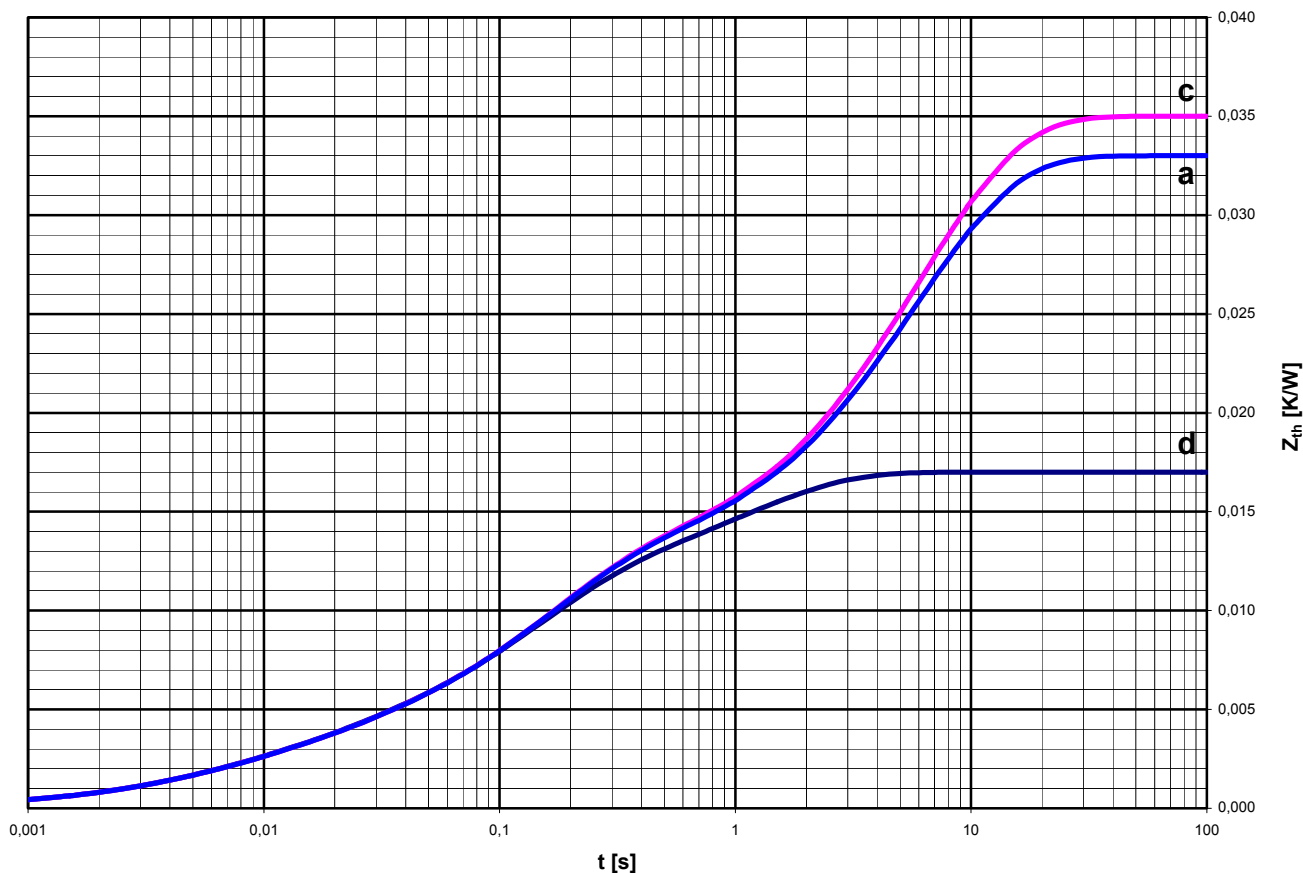



Sperrverzögerungsladung / recoverd charge

$$Q_r = f(-di/dt)$$

$T_{vj} = 125^{\circ}C, i_{TM} = 2000A, v_R = 0,5 \cdot V_{RRM}, v_{RM} = 0,8 V_{RRM}$

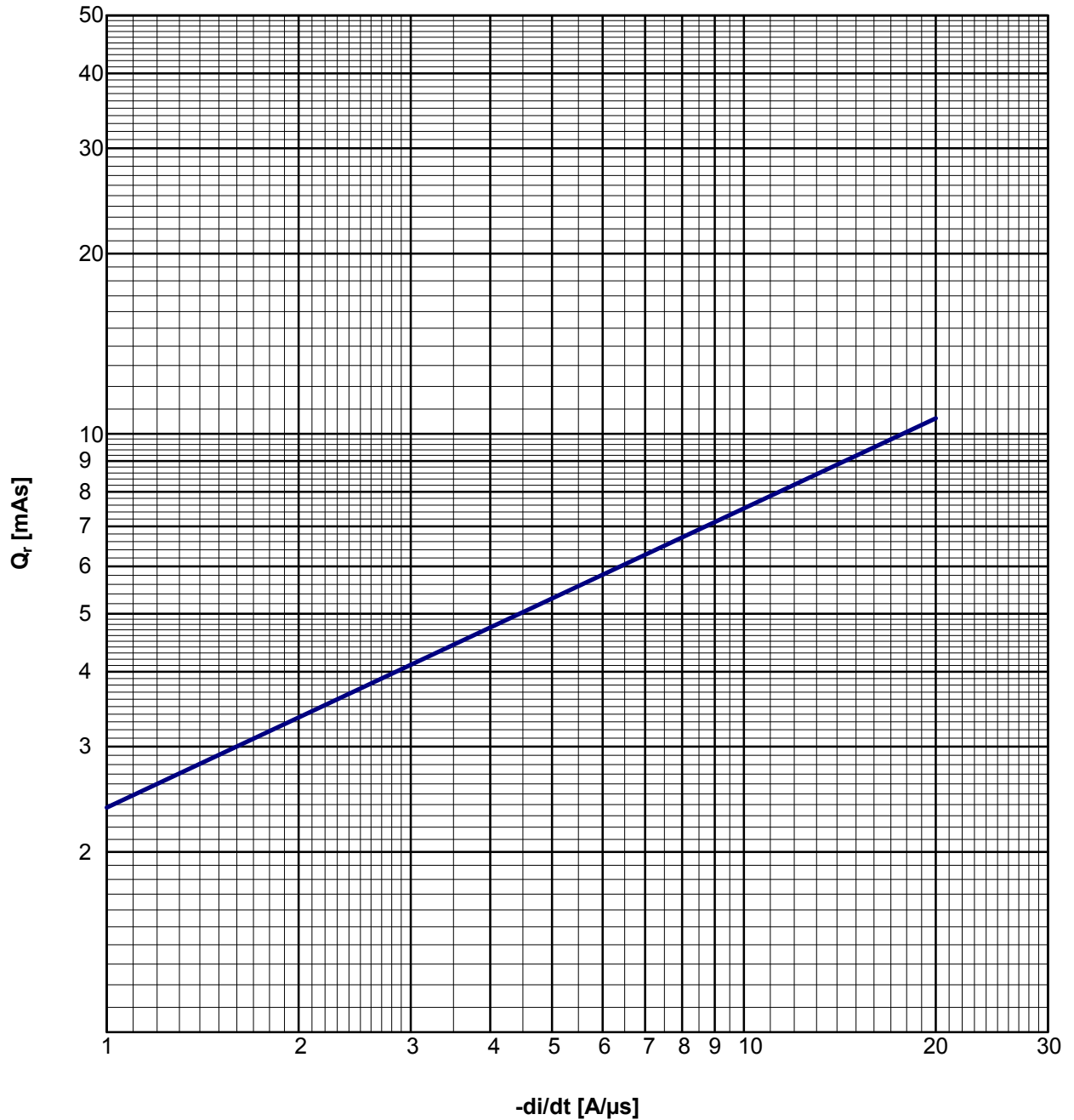





Rückstromspitze / peak reverse recovery current

$$I_{RM} = f(-di/dt)$$

$T_{vj} = 125^{\circ}C, i_{TM} = 2000A, v_R = 0,5 \cdot V_{RRM}, v_{RM} = 0,8 V_{RRM}$

