

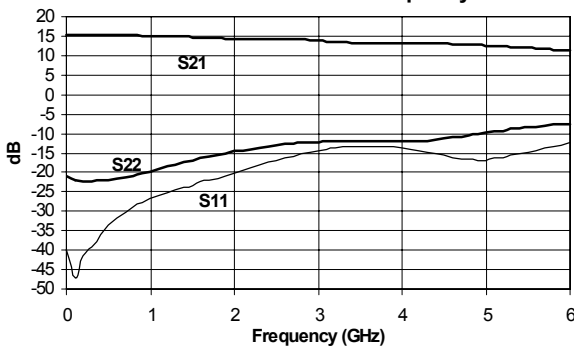

Product Description

Sirenza Microdevices' SBA-4089 is a high performance InGaP/GaAs Heterojunction Bipolar Transistor MMIC Amplifier. A Darlington configuration designed with InGaP process technology provides broadband performance up to 5 GHz with excellent thermal performance. The heterojunction increases breakdown voltage and minimizes leakage current between junctions. Cancellation of emitter junction non-linearities results in higher suppression of intermodulation products. Only a single positive supply voltage, DC-blocking capacitors, a bias resistor, and an optional RF choke are required for operation.

Gain and Return Loss vs Frequency



SBA-4089

DC-5 GHz, Cascadable InGaP/GaAs HBT MMIC Amplifier



Product Features

- IP3 = 33.5dBm @ 1950MHz
- Pout=13.3 dBm @-45dBc ACP IS-95 1950MHz
- Robust 1000V ESD, Class 1C
- Operates From Single Supply
- Patented Thermal Design

Applications

- PA Driver Amplifier
- Cellular, PCS, GSM, UMTS
- IF Amplifier
- Wireless Data, Satellite Terminals

Symbol	Parameter	Units	Frequency	Min.	Typ.	Max.
G	Small Signal Gain	dB	850 MHz 1950 MHz	13.5 13.1	15.0 14.6	16.5 16.1
P _{1dB}	Output Power at 1dB Compression	dBm	850 MHz 1950 MHz	17.5	19.2 19.0	
OIP ₃	Output Third Order Intercept Point	dBm	850 MHz 1950 MHz	31.5	36.5 33.5	
P _{OUT}	Output Power @ -45dBc ACP IS-95 9 Forward Channels	dBm	1950 MHz		13.3	
Bandwidth	Determined by Return Loss (>10dB)	MHz			4400	
IRL	Input Return Loss	dB	1950 MHz	14.0	21.0	
ORL	Output Return Loss	dB	1950 MHz	11.0	15.0	
NF	Noise Figure	dB	1950 MHz		4.8	5.8
V _D	Device Operating Voltage	V		4.6	5.0	5.4
I _D	Device Operating Current	mA		72	80	88
R _{TH, j-l}	Thermal Resistance (junction to lead)	°C/W			70	

Test Conditions: V_S = 8 V I_D = 80 mA Typ. OIP₃ Tone Spacing = 1 MHz, Pout per tone = 0 dBm
R_{BIAS} = 39 Ohms T_L = 25°C Z_S = Z_L = 50 Ohms

Performance tests and ratings for Sirenza Microdevices' products were performed internally by Sirenza and measured using specific computer systems and/or components and reflect the approximate performance of the products as measured by those tests. Any difference in circuit implementation, test software, or test equipment may affect actual performance. The information provided herein is believed to be reliable at press time and Sirenza Microdevices assumes no responsibility for the use of this information. All such use shall be entirely at the user's own risk. Prices and specifications for Sirenza Microdevices' products are subject to change without notice. Buyers should consult Sirenza Microdevices' standard terms and conditions of sale for Sirenza's limited warranty with regard to its products. No patent rights or licenses to any of the circuits described herein are implied or granted to any third party. Sirenza Microdevices does not authorize or warrant any product for use in life-support devices and/or systems.

Typical RF Performance at Key Operating Frequencies

Symbol	Parameter	Unit	Frequency (MHz)					
			100	500	850	1950	2400	3500
G	Small Signal Gain	dB	15.3	15.3	15.0	14.6	14.3	13.2
OIP ₃	Output Third Order Intercept Point	dBm	37.1	36.2	36.5	33.5	32.7	30.5
P _{1dB}	Output Power at 1dB Compression	dBm	19.0	19.1	19.0	19.0	18.3	16.3
IRL	Input Return Loss	dB	47	33	29	21	17.5	13.3
ORL	Output Return Loss	dB	22	22	21	15	13.3	12
S ₂₁	Reverse Isolation	dB	18	18	18.7	19	19	19
NF	Noise Figure	dB	4.1	4.3	4.2	4.8	---	---

Test Conditions: $V_S = 8\text{ V}$ $I_D = 80\text{ mA}$ Typ. OIP₃ Tone Spacing = 1 MHz, Pout per tone = 0 dBm
 $R_{BIAS} = 39\text{ Ohms}$ $T_L = 25^\circ\text{C}$ $Z_S = Z_L = 50\text{ Ohms}$

Absolute Maximum Ratings

Parameter	Absolute Limit
Max. Device Current (I_D)	130 mA
Max. Device Voltage (V_D)	6 V
Max. RF Input Power	+17 dBm
Max Operating Dissipated Power	0.65 W
Max. Junction Temp. (T_J)	+150°C
Operating Temp. Range (T_L)	-40°C to +85°C
Max. Storage Temp.	+150°C

Operation of this device beyond any one of these limits may cause permanent damage. For reliable continuous operation, the device voltage and current must not exceed the maximum operating values specified in the table on page one.
 Bias Conditions should also satisfy the following expression:
 $I_D V_D < (T_J - T_L) / R_{TH} + I$ $T_L = T_{LEAD}$

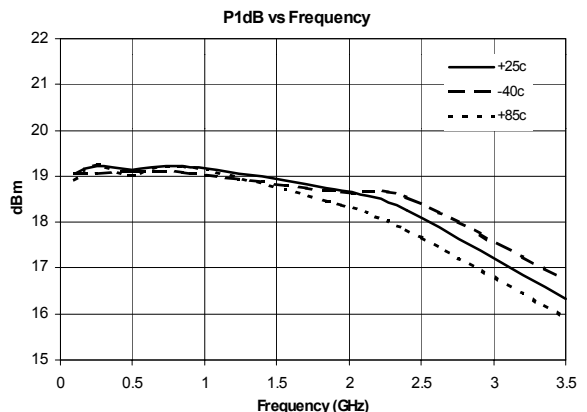
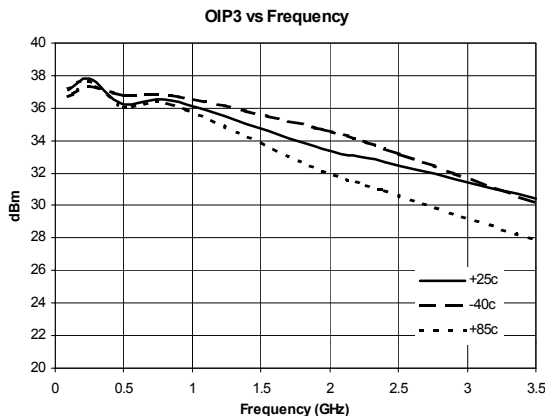
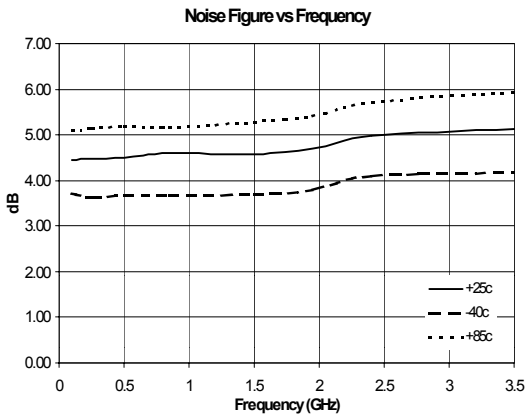

|S₁₁| vs. Frequency

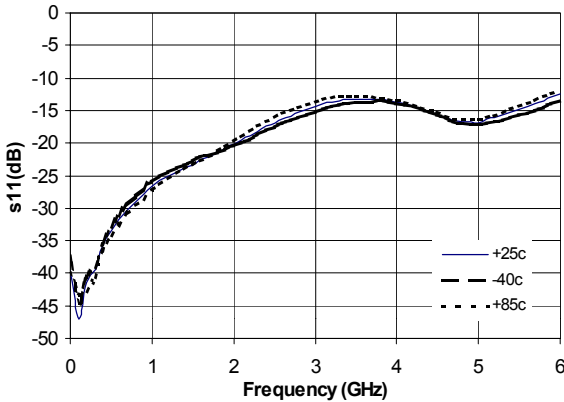

|S₂₁| vs. Frequency

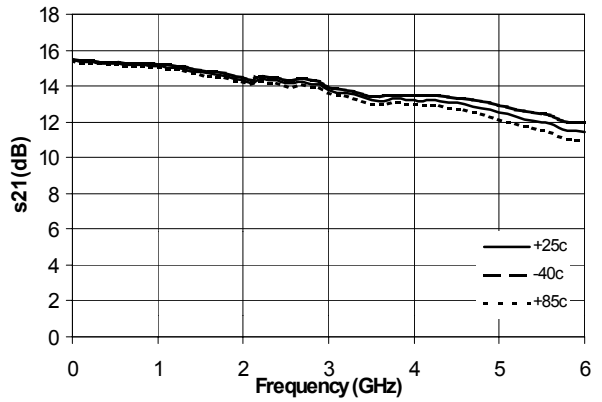

|S₁₂| vs. Frequency

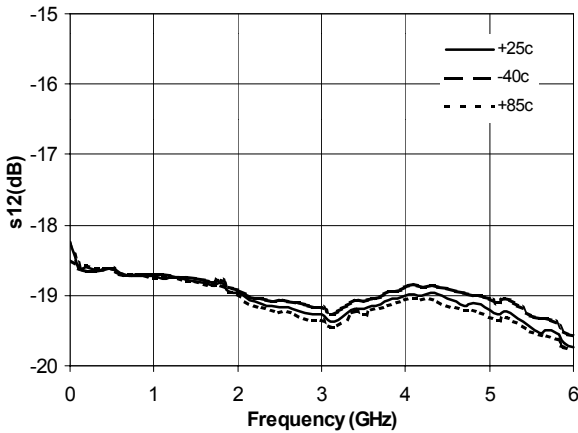

|S₂₂| vs. Frequency

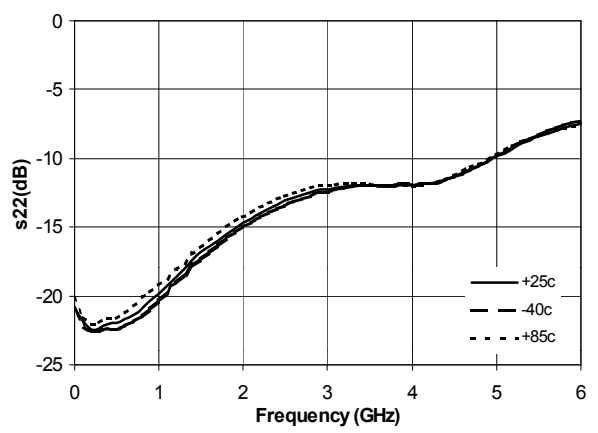

**IS-95 @ 850MHz
Adj. Channel Pwr. Vs. Channel Output Pwr.**

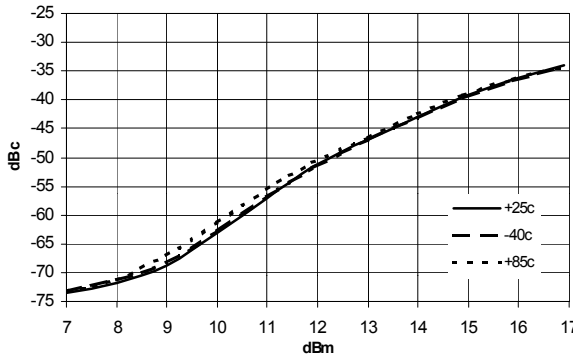

**IS-95 @ 1950MHz
Adj. Channel Pwr. Vs. Channel Output Pwr.**

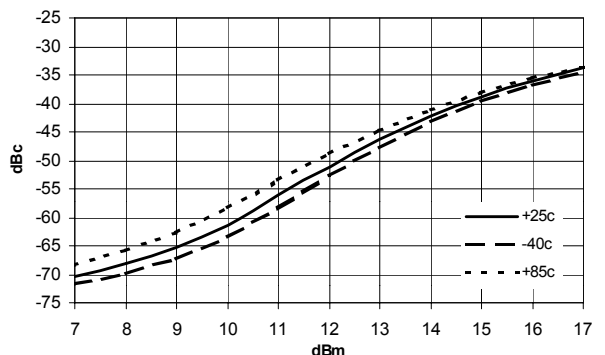

Basic Application Circuit

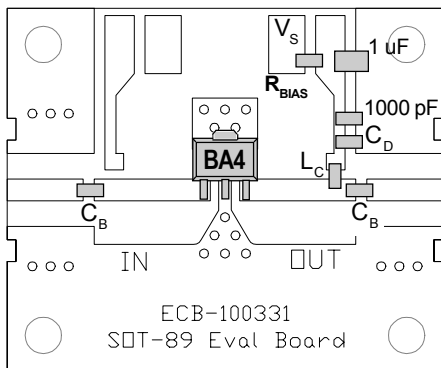
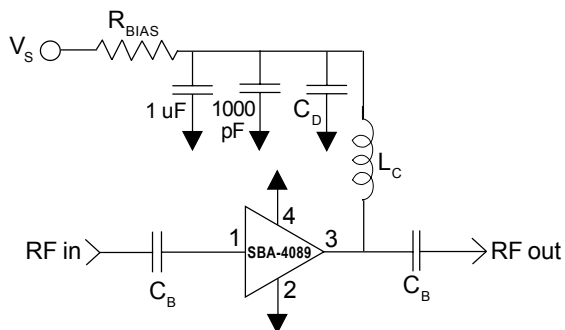

Part Identification Marking

The part will be marked with an "BA4" designator on the top surface of the package.

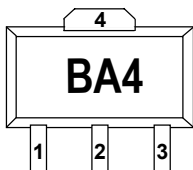

Caution: ESD sensitive

Appropriate precautions in handling, packaging and testing devices must be observed.

Application Circuit Element Values

Reference Designator	Frequency (Mhz)				
	500	850	1950	2400	3500
C _B	220 pF	100 pF	68 pF	56 pF	39 pF
C _D	100 pF	68 pF	22 pF	22 pF	15 pF
L _C	68 nH	33 nH	22 nH	18 nH	15 nH

Recommended Bias Resistor Values for I_D=80mA

$$R_{BIAS} = (V_S - V_D) / I_D$$

Supply Voltage(V _S)	7.5 V	8 V	10 V	12 V
R _{BIAS}	33 Ω	39 Ω	68 Ω	91 Ω

Note: R_{BIAS} provides DC bias stability over temperature.

Mounting Instructions

1. Solder the copper pad on the backside of the device package to the ground plane.
2. Use a large ground pad area with many plated through-holes as shown.
3. We recommend 1 or 2 ounce copper. Measurement for this data sheet were made on a 31 mil thick FR-4 board with 1 ounce copper on both sides.

Pin #	Function	Description
1	RF IN	RF input pin. This pin requires the use of an external DC blocking capacitor chosen for the frequency of operation.
2, 4	GND	Connection to ground. Use via holes for best performance to reduce lead inductance as close to ground leads as possible.
3	RF OUT/BIAS	RF output and bias pin. DC voltage is present on this pin, therefore a DC blocking capacitor is necessary for proper operation.

Part Number Ordering Information

Part Number	Reel Size	Devices/Reel
SBA-4089	7"	1000

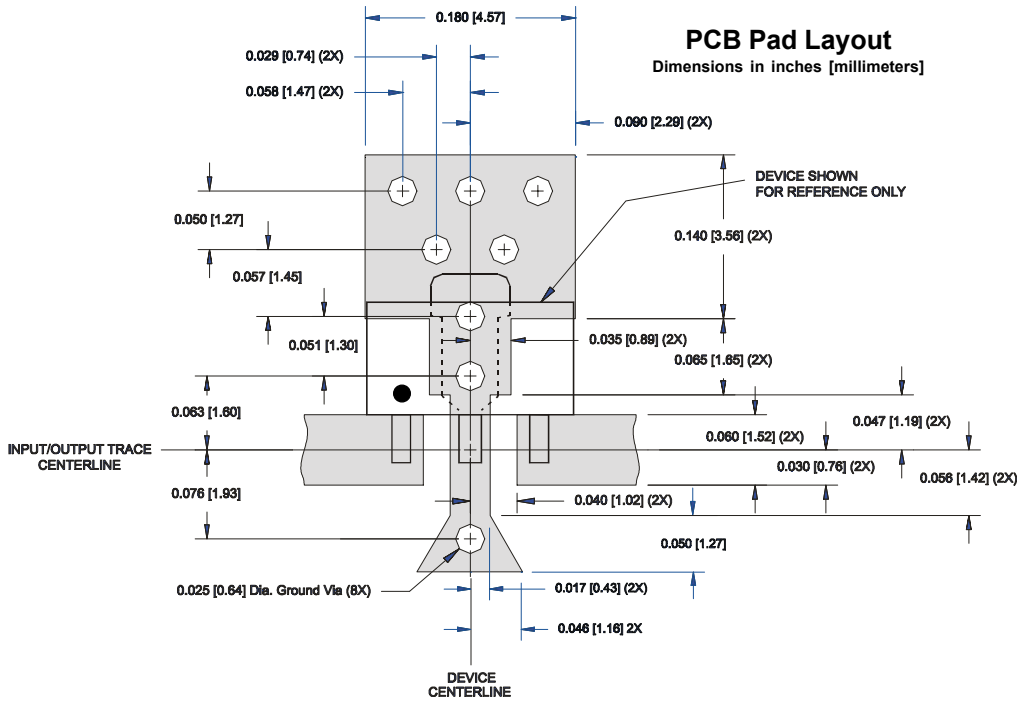

Nominal Package Dimensions

Dimensions in inches [millimeters]

Refer to package drawing posted at www.sirenza.com for tolerances.

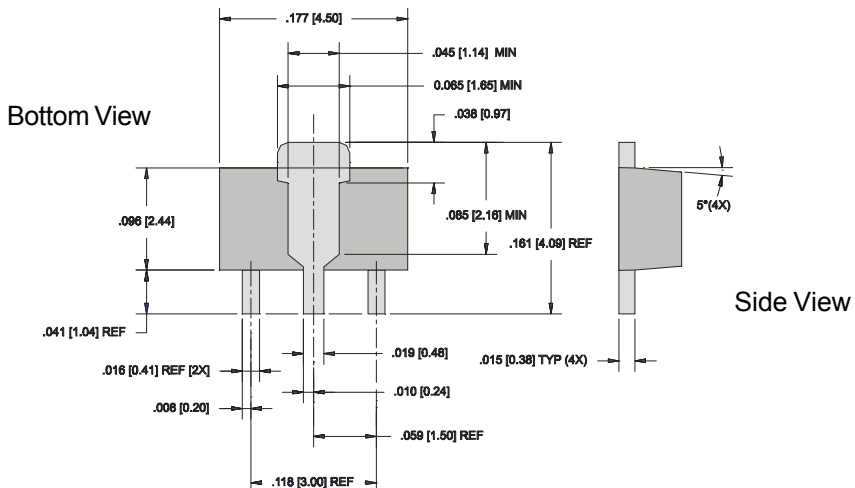

Side View