

TWO POWER MOSFETS IN HERMETIC ISOLATED SIP PACKAGE

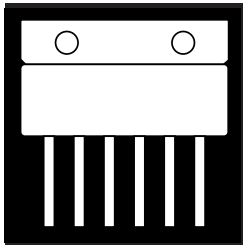

100V Thru 500V, Dual High Current, N-Channel MOSFETs

FEATURES

- Two Isolated MOSFETs In A Hermetic Metal Package
- Fast Switching, Low Drive Current
- Ease of Paralleling For Added Power
- Low $R_{DS(on)}$
- Available Screened To MIL-S-19500, TX, TXV And S Levels

DESCRIPTION

This series of hermetically packaged products feature the latest advanced MOSFET and packaging technology. They are ideally suited for Military requirements where small size, high performance and high reliability are required, and in applications such as switching power supplies, motor controls, inverters, choppers, audio amplifiers and high energy pulse circuits.

MAXIMUM RATINGS

PART NUMBER	V_{DS}	$R_{DS(ON)}$	$I_{D(MAX)}$
OM6214SS	100V	.065	30A
OM6215SS	200V	.095	25A
OM6216SS	400V	.3	15A
OM6217SS	500V	.4	13A

3.1

SCHEMATIC

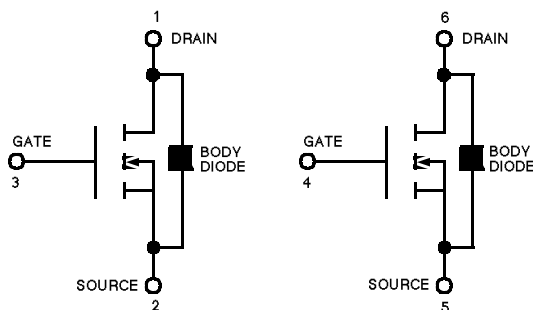

CONNECTION DIAGRAM

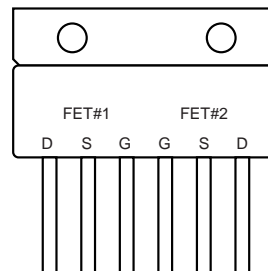

**ELECTRICAL CHARACTERISTICS: $T_C = 25^\circ$ unless otherwise noted
STATIC P/N OM6214SS (Per FET) (100 Volt)**

Parameter	Min.	Typ.	Max.	Units	Test Conditions
BV_{DSS} Drain-Source Breakdown Voltage	100			V	$V_{GS} = 0$, $I_D = 250$ mA
$V_{GS(th)}$ Gate-Threshold Voltage	2.0		4.0	V	$V_{DS} = V_{GS}$, $I_D = 250$ mA
I_{GSSF} Gate-Body Leakage			± 100	nA	$V_{GS} = \pm 20$ V
I_{DSS} Zero Gate Voltage Drain Current		0.1	0.25	mA	$V_{DS} = \text{Max. Rat.}$, $V_{GS} = 0$
		0.2	1.0	mA	$V_{DS} = 0.8$ Max. Rat., $V_{GS} = 0$, $T_C = 125^\circ$ C
$I_{D(on)}$ On-State Drain Current ¹	30			A	$V_{DS} = 2 V_{DS(on)}$, $V_{GS} = 10$ V
$V_{DS(on)}$ Static Drain-Source On-State Voltage ¹		1.1	1.3	V	$V_{GS} = 10$ V, $I_D = 20$ A
$R_{DS(on)}$ Static Drain-Source On-State Resistance ¹		.055	.065		$V_{GS} = 10$ V, $I_D = 20$ A
$R_{DS(on)}$ Static Drain-Source On-State Resistance ¹		.09	0.11		$V_{GS} = 10$ V, $I_D = 20$ A, $T_C = 125$ C

DYNAMIC

g_{fs} Forward Transductance ¹	9.0	10		S (M)	$V_{DS} = 2 V_{DS(on)}$, $I_D = 20$ A
C_{iss} Input Capacitance		2700		pF	$V_{GS} = 0$
C_{oss} Output Capacitance		1300		pF	$V_{DS} = 25$ V
C_{rss} Reverse Transfer Capacitance		470		pF	$f = 1$ MHz
$t_{d(on)}$ Turn-On Delay Time		28		ns	$V_{DD} = 30$ V, $I_D @ 20$ A
t_r Rise Time		45		ns	$R_g = 5.0$ Ω , $V_G = 10$ V
$t_{d(off)}$ Turn-Off Delay Time		100		ns	(MOSFET) switching times are essentially independent of operating temperature.
t_f Fall Time		50		ns	(MOSFET) switching times are essentially independent of operating temperature.

BODY-DRAIN DIODE RATINGS AND CHARACTERISTICS

I_S Continuous Source Current (Body Diode)			- 30	A	Modified MOSPOWER symbol showing the integral P-N Junction rectifier. 
I_{SM} Source Current ¹ (Body Diode)			- 140	A	
V_{SD} Diode Forward Voltage ¹			- 2.5	V	$T_C = 25$ C, $I_S = -40$ A, $V_{GS} = 0$
t_{rr} Reverse Recovery Time		400		ns	$T_J = 150$ C, $I_F = I_S$, $dl_F/ds = 100$ A/ms

1 Pulse Test: Pulse Width 300msec, Duty Cycle 2%.

**ELECTRICAL CHARACTERISTICS: $T_C = 25^\circ$ unless otherwise noted
STATIC P/N OM6215SS (Per FET) (200 Volt)**

Parameter	Min.	Typ.	Max.	Units	Test Conditions
BV_{DSS} Drain-Source Breakdown Voltage	200			V	$V_{GS} = 0$, $I_D = 250$ mA
$V_{GS(th)}$ Gate-Threshold Voltage	2.0		4.0	V	$V_{DS} = V_{GS}$, $I_D = 250$ mA
I_{GSSF} Gate-Body Leakage			± 100	nA	$V_{GS} = \pm 20$ V
I_{DSS} Zero Gate Voltage Drain Current		0.1	0.25	mA	$V_{DS} = \text{Max. Rat.}$, $V_{GS} = 0$
		0.2	1.0	mA	$V_{DS} = 0.8$ Max. Rat., $V_{GS} = 0$, $T_C = 125^\circ$ C
$I_{D(on)}$ On-State Drain Current ¹	25			A	$V_{DS} = 2 V_{DS(on)}$, $V_{GS} = 10$ V
$V_{DS(on)}$ Static Drain-Source On-State Voltage ¹		1.36	1.52	V	$V_{GS} = 10$ V, $I_D = 16$ A
$R_{DS(on)}$ Static Drain-Source On-State Resistance ¹		.085	.095		$V_{GS} = 10$ V, $I_D = 16$ A
$R_{DS(on)}$ Static Drain-Source On-State Resistance ¹		0.14	0.17		$V_{GS} = 10$ V, $I_D = 16$ A, $T_C = 125$ C

DYNAMIC

g_{fs} Forward Transductance ¹	8.0	12.5		S (M)	$V_{DS} = 2 V_{DS(on)}$, $I_D = 16$ A
C_{iss} Input Capacitance		2400		pF	$V_{GS} = 0$
C_{oss} Output Capacitance		600		pF	$V_{DS} = 25$ V
C_{rss} Reverse Transfer Capacitance		250		pF	$f = 1$ MHz
$t_{d(on)}$ Turn-On Delay Time		25		ns	$V_{DD} = 75$ V, $I_D @ 16$ A
t_r Rise Time		60		ns	$R_g = 5.0$ Ω , $V_G = 10$ V
$t_{d(off)}$ Turn-Off Delay Time		85		ns	(MOSFET) switching times are essentially independent of operating temperature.
t_f Fall Time		38		ns	(MOSFET) switching times are essentially independent of operating temperature.

BODY-DRAIN DIODE RATINGS AND CHARACTERISTICS

I_S Continuous Source Current (Body Diode)			- 25	A	Modified MOSPOWER symbol showing the integral P-N Junction rectifier. 
I_{SM} Source Current ¹ (Body Diode)			- 100	A	
V_{SD} Diode Forward Voltage ¹			- 2	V	$T_C = 25$ C, $I_S = -30$ A, $V_{GS} = 0$
t_{rr} Reverse Recovery Time		350		ns	$T_J = 150$ C, $I_F = I_S$, $dl_F/ds = 100$ A/ms

1 Pulse Test: Pulse Width 300msec, Duty Cycle 2%.

**ELECTRICAL CHARACTERISTICS: $T_C = 25^\circ$ unless otherwise noted
STATIC P/N OM6216SS (Per FET) (400 Volt)**

Parameter	Min.	Typ.	Max.	Units	Test Conditions
BV_{DSS} Drain-Source Breakdown Voltage	400			V	$V_{GS} = 0$, $I_D = 250$ mA
$V_{GS(th)}$ Gate-Threshold Voltage	2.0		4.0	V	$V_{DS} = V_{GS}$, $I_D = 250$ mA
I_{GSSF} Gate-Body Leakage			± 100	nA	$V_{GS} = \pm 20$ V
I_{DSS} Zero Gate Voltage Drain Current		0.1	0.25	mA	$V_{DS} = \text{Max. Rat.}$, $V_{GS} = 0$
		0.2	1.0	mA	$V_{DS} = 0.8$ Max. Rat., $V_{GS} = 0$, $T_C = 125^\circ$ C
$I_{D(on)}$ On-State Drain Current ¹	15			A	$V_{DS} = 2 V_{DS(on)}$, $V_{GS} = 10$ V
$V_{DS(on)}$ Static Drain-Source On-State Voltage ¹		2.0	2.4	V	$V_{GS} = 10$ V, $I_D = 8$ A
$R_{DS(on)}$ Static Drain-Source On-State Resistance ¹		0.25	0.3		$V_{GS} = 10$ V, $I_D = 8$ A
$R_{DS(on)}$ Static Drain-Source On-State Resistance ¹		0.50	0.60		$V_{GS} = 10$ V, $I_D = 8$ A, $T_C = 125$ C

DYNAMIC

g_{fs} Forward Transconductance ¹	8.0	9.6		S (M)	$V_{DS} = 2 V_{DS(on)}$, $I_D = 58$ A
C_{iss} Input Capacitance		2900		pF	$V_{GS} = 0$
C_{oss} Output Capacitance		450		pF	$V_{DS} = 25$ V
C_{rss} Reverse Transfer Capacitance		150		pF	$f = 1$ MHz
$t_{d(on)}$ Turn-On Delay Time		30		ns	$V_{DD} = 200$ V, $I_D @ 8.0$ A
t_r Rise Time		40		ns	$R_{\theta} = 5.0$ W, $V_{GS} = 10$ V
$t_{d(off)}$ Turn-Off Delay Time		80		ns	(MOSFET) switching times are essentially independent of operating temperature.
t_f Fall Time		30		ns	

BODY-DRAIN DIODE RATINGS AND CHARACTERISTICS

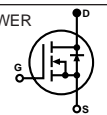
I_S Continuous Source Current (Body Diode)			- 15	A	Modified MOSPOWER symbol showing the integral P-N Junction rectifier. 
I_{SM} Source Current ¹ (Body Diode)			- 60	A	
V_{SD} Diode Forward Voltage ¹			- 1.6	V	$T_C = 25$ C, $I_S = -15$ A, $V_{GS} = 0$
t_{rr} Reverse Recovery Time		400		ns	$T_J = 150$ C, $I_F = I_S$, $di_F/ds = 100$ A/ms

1 Pulse Test: Pulse Width 300msec, Duty Cycle 2%.

**ELECTRICAL CHARACTERISTICS: $T_C = 25^\circ$ unless otherwise noted
STATIC P/N OM6217SS (Per FET) (500 Volt)**

Parameter	Min.	Typ.	Max.	Units	Test Conditions
BV_{DSS} Drain-Source Breakdown Voltage	500			V	$V_{GS} = 0$, $I_D = 250$ mA
$V_{GS(th)}$ Gate-Threshold Voltage	2.0		4.0	V	$V_{DS} = V_{GS}$, $I_D = 250$ mA
I_{GSSF} Gate-Body Leakage			± 100	nA	$V_{GS} = \pm 20$ V
I_{DSS} Zero Gate Voltage Drain Current		0.1	0.25	mA	$V_{DS} = \text{Max. Rat.}$, $V_{GS} = 0$
		0.2	1.0	mA	$V_{DS} = 0.8$ Max. Rat., $V_{GS} = 0$, $T_C = 125^\circ$ C
$I_{D(on)}$ On-State Drain Current ¹	13			A	$V_{DS} = 2 V_{DS(on)}$, $V_{GS} = 10$ V
$V_{DS(on)}$ Static Drain-Source On-State Voltage ¹		2.1	2.8	V	$V_{GS} = 10$ V, $I_D = 7$ A
$R_{DS(on)}$ Static Drain-Source On-State Resistance ¹		0.3	0.4		$V_{GS} = 10$ V, $I_D = 7$ A
$R_{DS(on)}$ Static Drain-Source On-State Resistance ¹		0.66	0.88		$V_{GS} = 10$ V, $I_D = 7$ A, $T_C = 125$ C

DYNAMIC

g_{fs} Forward Transconductance ¹	6.0	7.2		S (M)	$V_{DS} = 2 V_{DS(on)}$, $I_D = 7$ A
C_{iss} Input Capacitance		2600		pF	$V_{GS} = 0$
C_{oss} Output Capacitance		280		pF	$V_{DS} = 25$ V
C_{rss} Reverse Transfer Capacitance		40		pF	$f = 1$ MHz
$t_{d(on)}$ Turn-On Delay Time		30		ns	$V_{DD} = 210$ V, $I_D @ 7.0$ A
t_r Rise Time		46		ns	$R_{\theta} = 5.0$ W, $V_{GS} = 10$ V
$t_{d(off)}$ Turn-Off Delay Time		75		ns	(MOSFET) switching times are essentially independent of operating temperature.
t_f Fall Time		31		ns	

BODY-DRAIN DIODE RATINGS AND CHARACTERISTICS

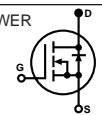
I_S Continuous Source Current (Body Diode)			- 13	A	Modified MOSPOWER symbol showing the integral P-N Junction rectifier. 
I_{SM} Source Current ¹ (Body Diode)			- 52	A	
V_{SD} Diode Forward Voltage ¹			- 1.4	V	$T_C = 25$ C, $I_S = -13$ A, $V_{GS} = 0$
t_{rr} Reverse Recovery Time		400		ns	$T_J = 150$ C, $I_F = I_S$, $di_F/ds = 100$ A/ms

1 Pulse Test: Pulse Width 300msec, Duty Cycle 2%.

OM6214SS - OM6217SS

ABSOLUTE MAXIMUM RATINGS ($T_C = 25^\circ\text{C}$ unless otherwise noted)

Parameter	OM6214SS	OM6215SS	OM6216SS	OM6217SS	Units	
V_{DS}	Drain-Source Voltage	100	200	400	500	V
V_{DGR}	Drain-Gate Voltage ($R_{GS} = 1\text{ M}$)	100	200	400	500	V
$I_D @ T_C = 25^\circ\text{C}$	Continuous Drain Current	± 30	± 25	± 15	± 13	A
$I_D @ T_C = 100^\circ\text{C}$	Continuous Drain Current	± 20	± 16	± 9	± 8	A
I_{DM}	Pulsed Drain Current ¹	± 140	± 100	± 60	± 52	A
$P_D @ T_C = 25^\circ\text{C}$	Maximum Power Dissipation	125	125	125	125	W
$P_D @ T_C = 100^\circ\text{C}$	Maximum Power Dissipation	50	50	50	50	W
Junction To Case	Linear Derating Factor ¹	1.0	1.0	1.0	1.0	W/°C
Junction To Ambient	Linear Derating Factor	.025	.025	.025	.025	W/°C
T_J	Operating and					
T_{stg}	Storage Temperature Range	-55 to 150	-55 to 150	-55 to 150	-55 to 150	°C
Lead Temperature	(1/16" from case for 10 secs.)	300	300	300	300	°C

¹ Pulse Test: Pulse width 300 μsec . Duty Cycle 2%.

THERMAL RESISTANCE (Per FET at $T_A = 25^\circ\text{C}$)

R_{thJC}	Junction-to-Case	1.0	°C/W	
R_{thJA}	Junction-to-Ambient	40	°C/W	Free Air Operation

POWER DERATING (Per Device)

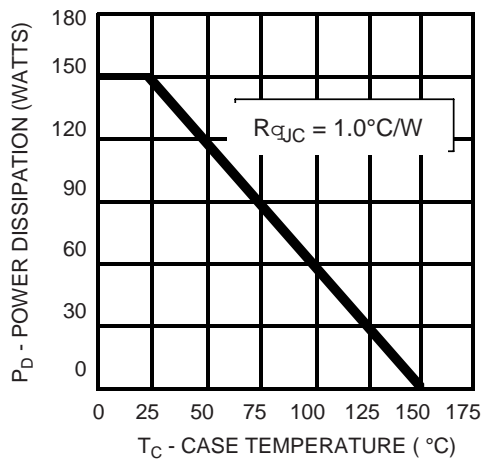

MECHANICAL OUTLINE

