

# LC4021

40 characters x 2 lines

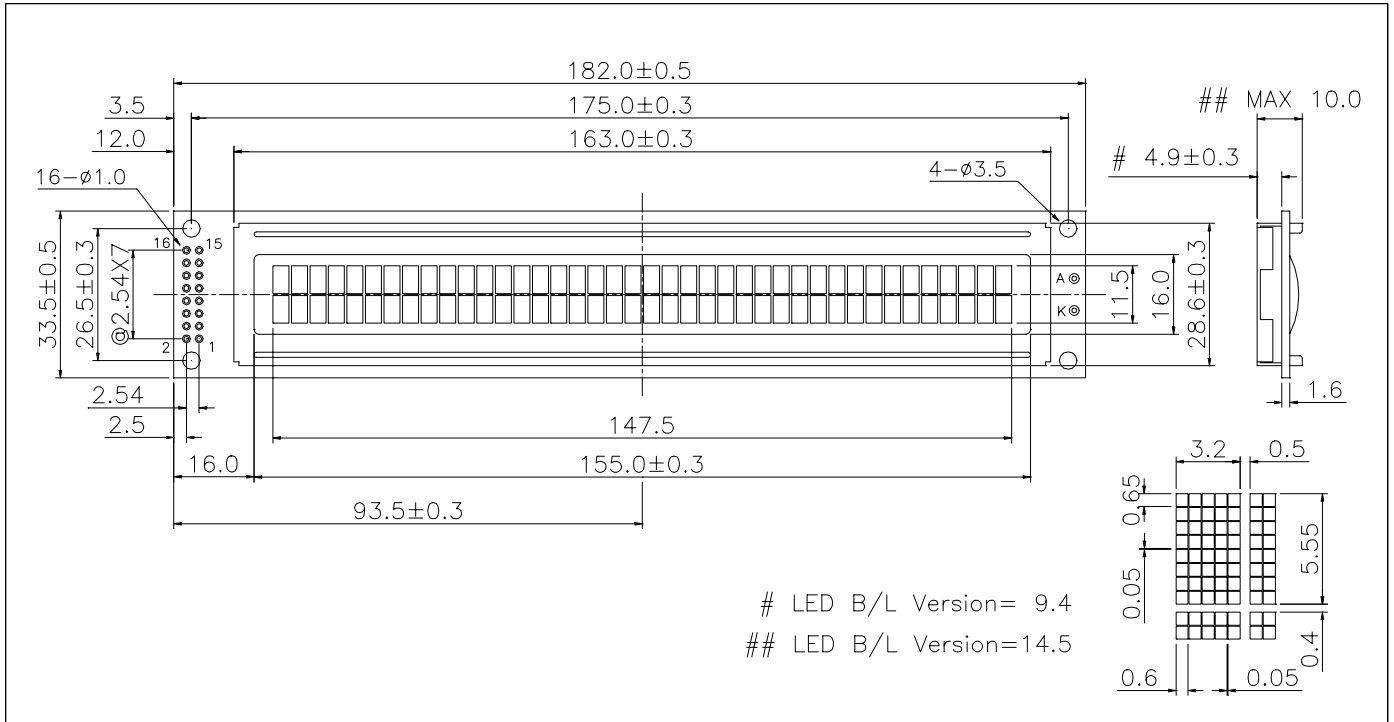

## ABSOLUTE MAXIMUM RATINGS

Item	Symbol	Min.	Max.	Unit
Supply Voltage(Logic)	V <sub>DD</sub> - V <sub>SS</sub>	-0.3	7.0	V
Supply Voltage(LCD)	V <sub>DD</sub> - V <sub>O</sub>	-0.3	13.0	V
Input Voltage	V <sub>I</sub>	-0.3	V <sub>DD</sub> + 0.3	V
Operating Temp.	T <sub>opr</sub>	-20	70	°C
Storage Temp.	T <sub>stg</sub>	-30	80	°C

## MECHANICAL DATA

Item	Nominal Dimensions	Unit
Module Size ( W x H x T )	182.0 x 33.5 x 10.0/14.5	mm
Viewing Area ( W x H )	155.0 x 16.0	mm
Character Size ( W x H )	3.2 x 5.55	mm
Dot Size ( W x H )	0.6 x 0.65	mm
Weight ( Reflective/LED )	Approx. 65 / 90	g

## ELECTRICAL CHARACTERISTICS ( V<sub>DD</sub>=5V±0.25V )

Item	Symbol	Test Condition	Min.	Typ.	Max.	Unit
Input High Voltage	V <sub>IH</sub>	--	2.2	--	V <sub>DD</sub>	V
Input Low Voltage	V <sub>IL</sub>	--	-0.3	--	0.6	V
Output High Voltage	V <sub>OH</sub>	I <sub>OH</sub> = -0.2mA	2.4	--	V <sub>DD</sub>	V
Output Low Voltage	V <sub>OL</sub>	I <sub>OL</sub> = 1.2mA	0	--	0.4	V
Supply Current	I <sub>DD</sub>	V <sub>DD</sub> = 5.0V	--	2.0	5.0	mA
LCD Driving Voltage	V <sub>DD</sub> - V <sub>O</sub>	T <sub>a</sub> =25°C	--	4.6	--	V

## PIN CONNECTIONS

Pin	Symbol	Level	Function
1	V <sub>SS</sub>	0V	GND
2	V <sub>DD</sub>	+5V	Power supply for logic
3	V <sub>O</sub>	--	Operating voltage for LCD
4	RS	H/L	H : Data L : Instruction code
5	R/W	H/L	H : Read L : Write
6	E	H, H > L	Enable signal
7	DB0	H/L	In 8-bit bus mode, used as low order bidirectional data bus. In 4-bit bus mode, open these pins.
8	DB1	H/L	
9	DB2	H/L	
10	DB3	H/L	
11	DB4	H/L	In 8-bit bus mode, used as high order bidirectional data bus. In 4-bit bus mode, used as both high and low order data bus.
12	DB5	H/L	
13	DB6	H/L	
14	DB7	H/L	
15	LEDA	+5V	Power supply for LED backlight
16	LEDK	0V	

## BLOCK DIAGRAM

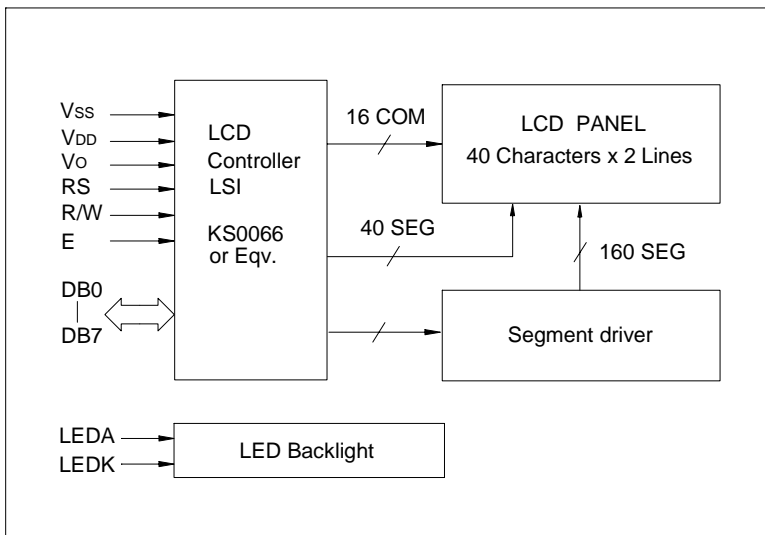

## LED BACKLIGHT SPECIFICATIONS (T<sub>a</sub>=25°C)

Item	Symbol	Typ.	Max.	Unit
Forward Voltage	V <sub>f</sub>	4.1	4.3	V
Forward Current	I <sub>f</sub>	250	--	mA
Emission Wave Length	λ <sub>p</sub>	568	--	nm