

FUNCTIONS

- Five 16 bit programmable up/down counters
- Programmable Pulse Generation
- Programmable Delay Generator
- Pulse Measurement
- Event Counting
- Frequency Measurement
- System Synchronization
- Real Time Clock

APPLICATIONS

- Computer System Timing
 - Real Time Clock with Alarm
 - Watchdog Timer
 - Programmable System/Bus Clock
 - Wait State Generation
- Data Acquisition
 - Programmable Converter Clock
 - Pulse Measurement
 - Frequency Counter
 - Event Counter
- ATE
 - Programmable Stimulus Generator
 - Timing Extremes Generator
- Laser Systems
 - Timing Sequencer
 - Programmable Delay Generator
 - External Equipment Synchronization
 - Burst Mode Generator
- Industrial Process Control
 - Pulse Frequency Sensor conversion
 - System Timing/Synchronization

EXTENDED FEATURES

- Up to 20 MHz Maximum input frequency
- Lower Power

STANDARD AM9513 FEATURES

- Five independent 16 bit counters
- Up/Down, Binary/BCD Counting
- Internal Binary/BCD Prescaling
- One Shot/Continuous Outputs
- Software/External triggering
- Tri-state Outputs
- Programmable output polarities
- Programmable gate polarities/edges
- Time of Day/Alarm Functions
- Programmable Internal/External Counter Source
- Fully AM9513 Hardware/Software Compatible
- Dual count registers on each counter



Figure 1 - CTS9513 DIP-40 Package

CTS9513 OVERVIEW

For two decades the most flexible counter/timer peripheral device available was the Advanced Micro Devices AM9513 Counter Timer. Until discontinued in 1995 the AM9513 was a leading device in industrial and scientific timing controllers. Its only limitation was its 7 Mhz maximum clock speed.....*until now*.....

Building on over two decades of successful use as the most flexible programmable counter/timer device, the CTS9513 breaks the old limitations of the AM9513 in a new technology device with over 3 times the speed of the venerable '9513 with 16 bit counters. Sporting up to a 20 MHz maximum Input clock, the CTS9513 allows timing resolutions of 50 ns and gate pulses as short as 50nS. This opens up a whole new range of capabilities and applications for this device.

The CTS9513 is an ideal solution for direct replacement or new designs. With its CMOS construction it consumes far less power and runs much cooler than the original NMOS device. Due to its ASIC construction it can not be obsoleted

The CTS9513 is Hardware and Software compatible with the AM9513, allowing use of your present software drivers. Standard Packaging for the CTS9513 is the DIP-40, PLCC-44

OTHER PRODUCTS

Celeritous Technical Service specializes in the creation of replacements for discontinued and obsolete ICs. Using the latest in ASIC technology and EDA Design Tools, Celeritous Technical can provide rapid, high quality, cost effective form, fit and function replacements for obsolete digital ICs. Visit us on the web at <http://www.celeritous.com> for more information on our products and services.

SPECIFICATIONS SUBJECT TO CHANGE WITHOUT NOTICE

DEVICE DESCRIPTION

The CTS9513 is a custom, high speed ASIC implementation of the AMD AM9513 System Timing Controller. The '9513 has long been the most versatile counter/timer peripheral device, featuring far more flexibility than competing timing devices such as the Intel 8253/8254, Motorola 6840 or others. A large installed base of devices and software drivers already exists.

The principal limitation of the AM9513 was its maximum frequency limitation of 7 Mhz imposed by its late 1970's NMOS LSI design. The CTS9513 shatters this barrier with a 20 MHz maximum clock speed and much lower power consumption due to its CMOS construction.

The CTS9513 Counter/Timer is capable of a wide variety of applications including, but not limited to:

- Event Counting
- Event Sequencing
- Programmable pulse generation
- Programmable delay generation
- Frequency counting
- Frequency synthesis
- Real Time Clock
- Alarm Clock Functions
- Watchdog Timing
- Retriggerable Pulse Generation
- Non-Retriggerable Pulse Generation
- Waveform Analysis
- Interrupt Generation
- Pulse burst generation

The user has control over key features such as:

- Output Polarities
- Output Impedance
- Input Trigger, Edge Polarities
- Hardware gating/triggering
- Software gating/triggering
- Count Up/Down
- BCD/Binary Counting
- Real time count register read
- Internal counter concatenation (up to 80 bits)
- Programmable frequency source selection
- Programmable internal clock pre-scaling

FEATURES

BACKWARDS COMPATIBLE

The CTS9513 maintains backwards compatibility with most AM9513 features, allowing continued use of your existing software drivers. Data may be transferred in 8 or 16 bit increments. All internal data paths in the CTS9513 are 16 bit. All '9513 commands registers and modes are supported.

PACKAGING

Figure 2 illustrates the DIP-40 Package pinout of the device which conforms to the original AM9513 pinouts.

Table 2 summarizes the pinouts of the PLCC-44 package illustrated in Figure 3 which conform to the original AM9513 PLCC pinouts.

SIGNALS

The following signal names and description conform to the original AM9513 device.

VCC

+5 Volt Power Supply

VSS

Ground

X1

The CTS9513 does not provide an internal crystal oscillator and must be driven from an external source. X1 should be left open

X2

X2 should be connected to an external TTL source and pulled up to VCC

FOUT (Frequency Divider Outputs)

The FOUT line is generated by internally programmable counters. The clock source for these counters may be any of the external GATE or SOURCE inputs as well as any of the internally prescaled clock outputs.

SOURCE1-5 (Count Source Inputs)

Source inputs 1-5 provide external clock source lines which may be routed to any of the internal counters or the FOUT divider. The active count edge for the source is programmed at the counter.

Symbol	Description	Min	Max	Units
V _{DD}	DC Supply Voltage	-0.3	7	Volts
V _{IN}	Input Voltage at Any Pin	-0.3	V _{DD} +3	Volts
T _{OP}	Operating Temperature Axl	-40	85	° C
T _{ST}	Storage Temperature	-55	150	° C

Table 1. Absolute Maximum Ratings

SPECIFICATIONS SUBJECT TO CHANGE WITHOUT NOTICE

CTS9513-2

5 Chan 16 bit 20MHz Counter/Timer

PLCC-44 Package Pinouts			
Pin	Signal	Pin	Signal
1	VCC	23	D8
2	OUT2	24	VSS
3	NC	25	D9
4	OUT1	26	D10
5	GATE1	27	D11
6	X1	28	D12
7	X2	29	D13
8	FOUT	30	D14
9	NC	31	D15
10	C/D	32	NC
11	WR	33	SOURCE5
12	CS	34	SOURCE4
13	RD	35	SOURCE3
14	NC	36	SOURCE2
15	D0	37	SOURCE1
16	D1	38	GATE5
17	D2	39	GATE4
18	D3	40	GATE3
19	D4	41	OUT5
20	D5	42	OUT4
21	D6	43	GATE2
22	D7	44	OUT3

Table 2. PLCC-44 Pinouts

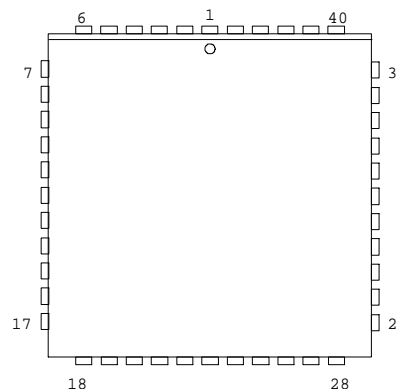

Figure 3. PLCC-44 Outline

CTSC9513A	x	x	-	x
Package				
Plastic DIP-40	P			
Plastic PLCC-44	J			
Temperature Range				
Industrial (-40 - 85° C)		I		
Maximum Clock Speed				
20 MHz				2

Table 2 - CTS9513 Ordering Information

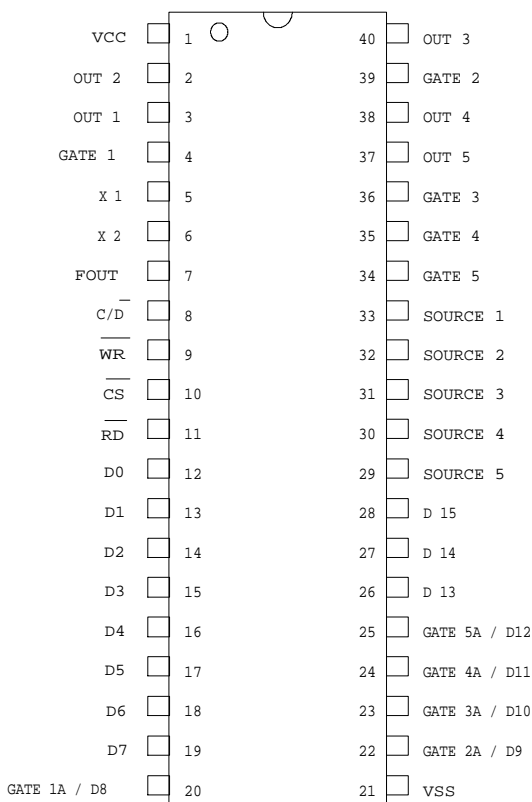

Figure 2 - CTS9513 DIP-40 Package Pinouts

GATE1-5 (Counter Gate Inputs)

Gate inputs are used to control counter behavior. Any gate may be routed to one of three internal counters. They may also be used as clock or count input sources for the internal counters or FOUT divider. The GATE lines may be programmed for use as counter enables, counter triggers or inhibits. Individual counters may be programmed for active polarity as well as to be level or edge sensitive to the GATE line.

OUT1-5 (Counter Outputs)

OUT1-5 are associated with individual counters. Outputs are tri-state and may be programmed by the counter for output polarity, initialized to a given state and programmed for pulse, square wave or complex duty cycle waveforms.

D0-15 (Data Bus)

D0-15 form a bi-directional 16 bit data bus for exchanging programming and status information with a host processor, or system. These lines act as inputs to the counter when CS and WR are asserted and as outputs when RD and CS are asserted. While CS is deasserted these lines are placed in a high impedance state.

SPECIFICATIONS SUBJECT TO CHANGE WITHOUT NOTICE

On power-up, the data bus is configured for 8 bit transfers. The data bus may be reconfigured for 16 bit by programming Master Mode register Bit 13. If D8-15 are not used they should be pulled up.

!CS (Chip Select Input)

The chip select line is an active low I/O control signal used to enable the device for read and write operations.

!WR (Write Input)

The write line is an active low I/O control signal which is used to transfer information from the data bus to one of the internal command or data registers.

!RD (Read Input)

The read line is an active low I/O control signal which is used to transfer information from one of the internal data or command registers to the data bus.

C/D (Control/Data Port Select Input)

The C/D line is used in conjunction with the CS, RD, and WR to select which internal command or data register is being written to or read from. The C/D line selects between the command and data register sets as summarized in Table 3

FUNCTIONAL DESCRIPTION

SYSTEM LEVEL

The CTS9513 is addressed by the external system through two address locations. Counter and command data are written to individual counters through a sequence of indirectly addressing the internal command or data register through the command port address, followed by a write to the data port address which points to the indirectly addressed register location.

Data is transferred through either two 8 bit transfers or a single 16 bit transfer. Pointer sequencing for 8 bit transfers is automatic and is transferred as least significant byte first, most significant byte second.

Rapid programming of the CTS9513 may be accomplished by use of the auto-increment feature of the data pointer. This feature is enabled by setting Master Mode Register bit 14 (MM14). When enabled, the data pointer may be sequenced through a single counter group, all counter group registers, all counter group Hold registers only, or just the control group registers.

INTERNAL CONFIGURATION

Overview

A simplified block diagram of the CTS9513 is shown in Figure 4. This diagram shows the major device elements consisting of:

- five counter groups,
- internal frequency prescaler which divides down the primary external clock source from clock input X2,
- external FOUT clock prescalers which provide prescaled or divided outputs from a variety of sources,
- the Bus interface,
- Master mode register and
- the status register.

Not shown are the extended set registers, power-on reset circuitry or internal control lines. The counter group block diagrams are shown in Figures 5 and 6. Counter groups 1 and 2 as shown in Figure 5 have an additional programmable alarm register and 16 bit comparator for implementation of time-of-day and alarm functions.

Counter Groups

All of the counter groups have a 16 bit counter and four programmable registers. The primary and auxiliary counter mode register controls the count source, gating and counting modes, input and output polarities, binary or BCD counting and other parameters.

Load Register

The Load register is the primary register used for storing count-up or count-down values which may be automatically reloaded into the counter for repetitive counting.

Hold Register

The Hold register may be used for storing the instantaneous count value without disturbing the count process for reading by the host system. It may also be used in certain count modes for storing alternate count values and alternately counting the load and hold register values to generate complex waveforms.

Counter Outputs

Each of the counters has a single dedicated output pin which is programmable for polarity, tri-state, low-Z to ground and a variety of output modes as described later. This flexibility allows operation in a variety of bus and processor architectures.

Source Inputs

Each counter group may be programmed for a variety of count sources including any of the five source input lines, any of the internal prescaler outputs or

the output of the previous counter, allowing counter concatenation and FOUT divided outputs.

Gate Inputs

Gate inputs are used for external hardware triggering or synchronization of the counters. Each counter may be programmed to be gated from its own gate line or the gate lines from the previous or next counter. The gate lines may also be programmed to be level or edge sensitive and respond to active high or low signals.

The gate line may be used to either initiate one or more count sequences or used as a count enable line, allowing the counter to count only while the gate line is held active. Another mode allows the counter to be reloaded from the load or hold register depending on the state of the gate line.

PROGRAMMING

REGISTER PROGRAMMING

Data Bus Operation

Table 3 summarizes the I/O control signal and data status during bus reads and writes to the CTS9513. The interface control logic assumes that

- RD and WR are never active simultaneously
- RD, WR, C/D are ignored unless CS is asserted.

Register Programming

Accessing and writing to a specific data or command register from the data port is as follows.

Set Data Pointer

- 1 Select the appropriate data pointer value to access the desired register (example Counter group 1 Mode register 0x01)
- 2 Write LOAD DATA POINTER command to primary command address (write 0x0001 to device address 0x01) to set data pointer to Counter Group 1 Mode register.

This points the data port to the Group 1 mode register and set the word pointer to 1 indicating a least significant word is expected.

WRITING TO REGISTERS

Write Data to Register

- 1 If the 16 bit transfer mode is selected, the next write to the Primary Data Port (Device Address 0x00) will write data to the Counter mode register.
- 2 If the 8 bit transfer mode is selected, the next write to the Primary Data Port Address will expect the least significant word of the register value, followed by a

write of the most significant word to the data port. The internal word pointer is automatically incremented.

- 3 If an automatic sequence command has been given the data pointer will automatically be sequenced to the next register.

READING REGISTERS

Reading from a device register follows the write sequence very closely, requiring a write to the command register to set the appropriate data pointer, followed by a read or reads from the data port. Several items should be noted when reading from the device registers:

- 1 The data pointer should always be reloaded before reading from the data port if the prior command was anything but a LOAD DATA POINTER command in order to update the Read data pre-fetch latch.
- 2 A LOAD DATA POINTER command should be issued to the device prior to reading a HOLD register following a hardware triggered SAVE of the counter contents to the HOLD register.

COMMANDS

COUNTER COMMANDS

Counter commands are divided into two main groups. Those commands which directly affect counter operation, often shortcuts to programming specific register functions, and those associated with indirectly addressing the counters' internal registers.

Counter control commands can be further subdivided into those commands which affect individual counter operation and those which affect the overall device operation.

Table 4 Lists the commands associated with indirect addressing of the counter internal registers. These commands point the data port to the appropriate internal register in order to read or write to them.

Table 5 Lists the commands associated with controlling the actions of individual counters. They are made up basically of the ARM, DISARM, LOAD, SAVE, CLEAR, SET and STEP commands.

ARM Command

A counter must be ARMed before it can commence counting. Once ARMed, a counter may be programmed to begin counting immediately or to await a hardware trigger to initiate counting.

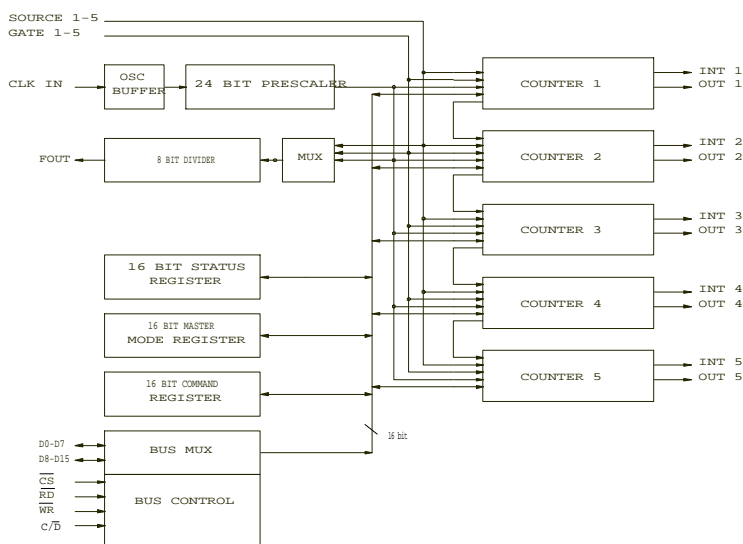

Figure 4 - CTS9513 Counter Block Diagram

DISARM Command

The DISARM command halts and disables any further counting regardless of any hardware gating or triggering. While DISARMed a counter may be reloaded, SAVED or incremented or decremented using the STEP Command

LOAD Command

The LOAD command is used to load the counter with the value stored in either the associated Load or Hold register. It may also serve as an automatic retrigger of the counter once the counter is loaded.

SAVE Command

The SAVE command is used to save the contents of the counter while counting continues. This allows the counter value to be read without interfering with the counter. Subsequent SAVE commands will overwrite any previous contents of the Hold register.

CLEAR Command

The CLEAR command is used to reset the counter output toggle to initialize it to a low state. This command is only active if the output toggle is programmed. It is inactive if a Terminal Count output is specified.

SET Command

The SET command is used to set the counter output toggle to initialize it to a high state. This command is only active if the output toggle is programmed. It is inactive if a Terminal Count output is specified.

STEP Command

The STEP Command increments or decrements the selected counter by one depending on the operating mode.

Master Mode Commands

A number of commands directly affect the Master Mode Register without having to write to it directly. These commands affect primarily the modes of the data path, data pointer sequencing, enabling the divided FOUT output clocks and clearing of latched interrupt outputs from the counters. Table 6 summarizes these commands.

REGISTER DEFINITIONS

STATUS REGISTER

- The 16 bit Status Register indicates the
- 1 Status of the internal word pointer
 - 2 Status of the counter outputs
 - 3 Status of the counter interrupt outputs

When reporting the status of the counter output, the status bit reflects the exact state of the output pin, regardless of how the output pin state or toggle is programmed.

CS	RD	WR	C/D	Dx
1	X	X	X	High Impedance
0	0	1	0	Read Data
0	0	1	1	Read Command
0	1	0	0	Write Data
0	1	0	1	Write Command
0	0	0	X	Illegal

Table 3 - CTS9513 Bus Control Line States

CTS9513-2 5 Chan 16 bit 20MHz Counter/Timer

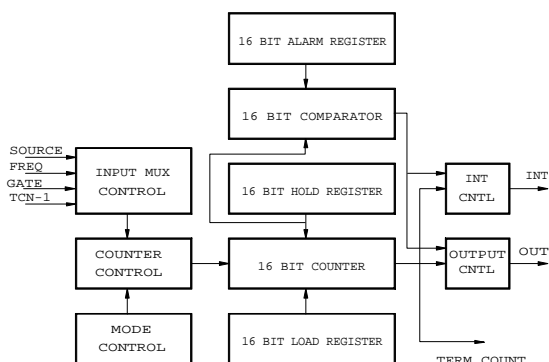

Figure 5 - CTS9513 Counter Groups 1 & 2

When an output low impedance to ground output is programmed, the Status bit reflects an Active High status. When the output is programmed for a high impedance output or is externally inhibited, the status register reflects an active low output. Table 7 summarizes the status register bit assignments.

Master Mode Commands

The Master Mode registers are 16 bit read/write registers used to set counter parameters not associated with individual counters. These parameters include setting the data bus width, prescaling factors, Time of day functions and data pointer sequencing. The primary Master Mode Register is identical in function to the original '9513 device. The auxiliary Master Mode Register is used to program extended features of the CTS9513. If the auxiliary register is not programmed the device behaves as an original '9513 device. Table 8 summarizes the primary and auxiliary Master Mode Register bit assignments.

On Power-up the Master Mode register is cleared to all zeros resulting in the following default conditions:

- 1 Time of Day disabled
- 2 Alarm Comparators Disabled
- 3 FOUT source is F1
- 4 FOUT divider set for divide by 16
- 5 FOUT enabled
- 6 Data Bus 8 bits
- 7 Data Pointer Sequencing enabled
- 8 Frequency scaling Binary

Time of Day (Bits MM0-1)

Bits MM0 and MM1 control the Time-of-day functions for counters 1 and 2. When enabled, additional counter logic is enabled to allow the two counters to operate as a 24 hour clock.

Counters 1 and two must be programmed for BCD counting. To initialize the time, appropriate values are loaded in the Counter Load registers. To read the time a SAVE command is issued to Counters 1 and 2 and the values read from the Hold registers.

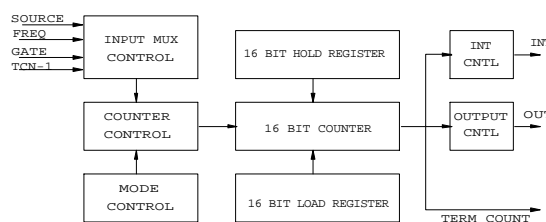

Figure 6 - CTS9513 Counter Groups 3 - 5

Table 9 illustrates the Time-of-day storage configuration. In short, Counter 2 bits 8-15 form a two digit BCD Hours counter, Bits 0-7 form a two digit BCD Minutes counter. Counter 1 bits 8-15 form a two digit BCD seconds counter, Bits 4-7 form a tenth second counter and Bits 0-3 form a division factor for the input source for divide by 5, 6 or 10.

Comparator Enable (Bits MM2-3)

The two 16 bit comparators on counters 1 and 2 may be used in any mode. When enabled, the output of the comparators are routed to the output of the counter. The output will be asserted when the comparison between the counter and alarm register contents are true. It will remain asserted as long as the counter and alarm register remain the same.

In the Time-of-Day mode the comparators operate in conjunction such that the output of the counter 2 comparator is asserted only when both comparators 1 and 2 are true. the comparator 1 output will continue to operate normally.

FOUT Source (Bits MM4-7)

Fifteen different sources may be routed to the input of the FOUT divider, including the five SOURCE inputs, five GATE inputs and five of the internal divided frequencies derived from the X1 input. Additional Sources may be programmed using the extended Master mode register functions.

FOUT1 Divider (Bits MM8-11)

FOUT may be divided by 1 to 16. Master mode bits MM8-11 allow programming of the FOUT divider from 1 to 16 inclusive. Higher order division factors are programmed through the extended Master Mode register functions.

FOUT Enable (Bit MM12)

The FOUT output may be enabled or disabled and placed in a low impedance state to ground under software control.

Bus Width (Bit MM13)

When set, this bit places the device into a 16 bit external data bus mode. When cleared, the external data bus is set to 8 bits and registers are loaded 8 bits at a time, least significant word first.

SPECIFICATIONS SUBJECT TO CHANGE WITHOUT NOTICE

Data Pointer Sequencing (Bit MM14)

When cleared, this bit enables automatic sequencing of the data pointer as defined by the data pointer commands. When set, the data pointer contents may only be changed by command.

Scaling (Bit MM15)

This bit determines whether the internal frequency prescaler operates as a BCD or Binary Divider. Figure 6 illustrates the internal 16 bit prescaler and its outputs.

COUNTER REGISTERS

Load Register

The load register is a read/write counter register used to store the counter initial value. The load register value can be transferred into the counter each time the counter reaches a "terminal count." A "terminal count" is defined as that period of time the counter value would have been zero if an external value had not been transferred into the counter. In all operating modes the value in either the load or hold register is transferred into the counter when the counter reaches terminal count.

Hold Register

The hold register is a read /write dual purpose register. In some operating modes the hold register may be used to store counter instantaneous values on command without disturbing the counter action for readout by the host. Other operating modes allow the hold register to be used as storage for counter values in a fashion similar to the Load register. The counter may be loaded from the Hold register at terminal count, or alternately loaded from the Load and Hold register at terminal count.

Alarm Register

Counters 1 and 2 contain an additional 16 bit Alarm register and corresponding 16 bit comparator. When the value in the counter matches the value stored in the Alarm register the output pin for the counter goes true. The output remains true as long as the counter value matches the Alarm register value. The output may be programmed for active high or active low by the counter mode register.

COUNTER MODE REGISTER

Each counter group contains a mode control register which controls the counter behavior, gating and output active states and polarities and counter source. The counter mode register is initialized at power-up to all zeroes. This translates to an initial counter mode of:

- 1 Output Low impedance to Ground
- 2 Count Down
- 3 Count Binary
- 4 Count Once
- 5 Load Register Selected

- 6 No Retriggering
- 7 F1 source selected
- 8 Positive-true input polarity
- 9 No Gating

The Counter Mode Register must be loaded while the counter is disarmed.. Table 10 summarizes the Counter Mode Register bit assignments.

Output Control (Bits CM0-2)

The counter output may be configured to be disabled, programmed to follow the counter terminal count or to toggle its state at each terminal count. The output logic for each counter is shown in Figure 8.

The output may be disabled by either placing it in a high impedance state or in a low impedance state to ground. The outputs may also be hardware inhibited with the line.

In the Terminal count mode, the output may be programmed to output an active high or active low pulse which is equal to one count source clock period.

In the output toggle mode, the output changes state whenever the counter reaches a terminal count. The output state may be initialized with the SET and CLEAR counter commands.

C7	C6	C5	C4	C3	C2	C1	C0	Command Register Bit
0	0	0	E2	E1	G4	G2	G1	Load Data Pointer Commands
								G1-4 Group Pointer
								E1-2 Element Pointer
0	0	0	0	0	0	0	0	Reserved
0	0	0	0	0	0	0	1	Counter 1 Mode Register
0	0	0	0	0	0	1	0	Counter 2 Mode Register
0	0	0	0	0	0	1	1	Counter 3 Mode Register
0	0	0	0	0	1	0	0	Counter 4 Mode Register
0	0	0	0	0	1	0	1	Counter 5 Mode Register
0	0	0	0	0	1	1	0	Reserved
0	0	0	0	0	1	1	1	Alarm Register 1 / Control Cycle
0	0	0	0	1	0	0	0	Reserved
0	0	0	0	1	0	0	1	Counter 1 Load Register
0	0	0	0	1	0	1	0	Counter 2 Load Register
0	0	0	0	1	0	1	1	Counter 3 Load Register
0	0	0	0	1	1	0	0	Counter 4 Load Register
0	0	0	0	1	1	0	1	Counter 5 Load Register
0	0	0	0	1	1	1	0	Reserved
0	0	0	0	1	1	1	1	Alarm Register 2 / Control Cycle
0	0	0	1	0	0	0	0	Reserved
0	0	0	1	0	0	0	1	Counter 1 Hold Register
0	0	0	1	0	0	1	0	Counter 2 Hold Register
0	0	0	1	0	0	1	1	Counter 3 Hold Register
0	0	0	1	0	1	0	0	Counter 4 Hold Register
0	0	0	1	0	1	0	1	Counter 5 Hold Register
0	0	0	1	0	1	1	0	Reserved
0	0	0	1	0	1	1	1	Master Mode Register / Control Cycle
0	0	0	1	1	0	0	0	Reserved
0	0	0	1	1	0	0	1	Hold Register Cycle
0	0	0	1	1	0	1	0	Hold Register Cycle
0	0	0	1	1	0	1	1	Hold Register Cycle
0	0	0	1	1	1	0	0	Hold Register Cycle
0	0	0	1	1	1	0	1	Hold Register Cycle
0	0	0	1	1	1	1	0	Reserved
0	0	0	1	1	1	1	1	Status Register

Table 4 - CTS9513 Data Pointer Commands

SPECIFICATIONS SUBJECT TO CHANGE WITHOUT NOTICE

Count Control (Bits CM3-7)

Whenever the counter reaches a TC, the counter automatically reloads the counter from the Load or Hold Register. Which register the counter loads from, whether the counter counts repeatedly or once, whether the counter counts binary or BCD and whether the counter is under hardware control is controlled by the Count control.

Bit CM3 controls whether the counter counts in Binary or BCD fashion. Bit CM4 determines whether the counter counts up or down. Bit CM5 determines whether the counter counts once and disarms itself, or will continue counting and reloading the counter until commanded to disarm.

Bit CM6 determines the source from which the counter will be reloaded. The actions of CM6 depend on the gating control settings. If CM6 is cleared, the counter reloads from the Load Register at TC. If CM6 is set, the counter may reload from either the Load or the hold register depending on the gating mode. It may alternate with the Load register or be controlled from the gate to reload from the load or hold register.

Bit CM7 controls whether hardware retriggering of the counter is enabled. Its actions depend on the settings of CM5, CM6 and the gating controls.

If some type of gating is enabled and CM7 is cleared, hardware retriggering is disabled. When CM7 is set, hardware retriggering is enabled and the counter is retriggered any time an active gate edge is received. When retriggered the counter value is saved in the Hold register and the counter reloaded from the Load register.

If no gating is enabled and CM7 is cleared, the gate input has no effect on counting. If CM7 is set then the Gate input controls whether the counter is reloaded from the Load or Hold Register.

C7	C6	C5	C4	C3	C2	C1	C0	Command Register Bit
			S5	S4	S3	S2	S1	S1-5 - Counter Group Select
0	0	1	S5	S4	S3	S2	S1	Arm Selected Counters
0	1	0	S5	S4	S3	S2	S1	Load Selected Counters
0	1	1	S5	S4	S3	S2	S1	Load and Arm Selected Counters
1	0	0	S5	S4	S3	S2	S1	Disarm and Save Selected Counters
1	0	1	S5	S4	S3	S2	S1	Save selected counters to Hold Registers
1	1	0	S5	S4	S3	S2	S1	Disarm Selected Counters
					N4	N2	N1	N1-4 Counter Group Select (001 = N = 101)
1	1	1	0	0	N4	N2	N1	Clear Selected Counter Toggle Out
1	1	1	0	1	N4	N2	N1	Set Selected Counter Toggle Out
1	1	1	1	0	N4	N2	N1	Step Selected Counter (up/down by CM3)

Table 5 - Counter Action Related Commands

Count Source (Bits CM8-12)

The count source determines which source is used as an input to the counter. There are 20 possible count sources, 16 of which may be selected with bits CM8-12. Additional Count sources may be specified with the extended registers. Figure 8 illustrates the internal 24 bit prescaler whose outputs may be used as count sources.

Gating Control (Bits CM13-15)

Gating control determines whether the counter is hardware gated or not. When gating is disabled the counter will continue as long as the counter is armed. If any gating mode is enabled the counter action is determined by some hardware gate condition.

Gating of the counter may be controlled from the gate line associated with the counter or gate lines associated with adjacent counters. Gating on the line associated with the counter may be programmed for edge or level sensitive, active high or active low. The counter may also be gated by the TC output of the previous counter. The gating control logic is outlined in Figure 7.

COUNTER MODES

Counter modes continue as in the '9513 to retain their mode designations A-X, with modes M, P, T, U and V reserved. Tables 11-12 summarize the counter modes and the associated settings of the counter mode bits CM5-7 and CM13-15.

Figures 10 through 28 illustrate the counter modes. All representative waveforms assume counting down on rising source edges. A TC mode and Toggled output waveform are shown in each waveform. For waveforms which disarm automatically on TC the software ARM command is shown in conjunction with

C7	C6	C5	C4	C3	C2	C1	C0	Command Register Bit
1	1	1	0	0	0	0	0	Clear MM14 (Enable Data Pointer Sequencing)
1	1	1	0	0	1	1	0	Clear MM12 (FOUT Gate On)
1	1	1	0	0	1	1	1	Clear MM13 (Enable 8 bit Bus Mode)
1	1	1	0	1	0	0	0	Set MM14 (Disable Data Pointer Sequencing)
1	1	1	0	1	1	1	0	Set MM12 (FOUT Gate Off)
1	1	1	0	1	1	1	1	Set MM13 (Enable 16 bit Bus Mode)
1	1	1	1	0	0	0	0	(Originally Reserved)
1	1	1	1	0	1	1	0	(Originally Reserved)
1	1	1	1	0	1	1	1	(Orig Reserved)
1	1	1	1	1	0	0	0	Enable Write Pre-Fetch
1	1	1	1	1	0	0	1	Disable Write Pre-Fetch
1	1	1	1	1	0	1	0	(Orig Reserved)
1	1	1	1	1	0	1	1	(Orig Reserved)
1	1	1	1	1	1	0	0	(Orig Reserved)
1	1	1	1	1	1	0	1	(Orig Reserved)
1	1	1	1	1	1	1	0	(Orig Reserved)
1	1	1	1	1	1	1	1	Master Reset

Table 6 - Device Level Commands

SPECIFICATIONS SUBJECT TO CHANGE WITHOUT NOTICE

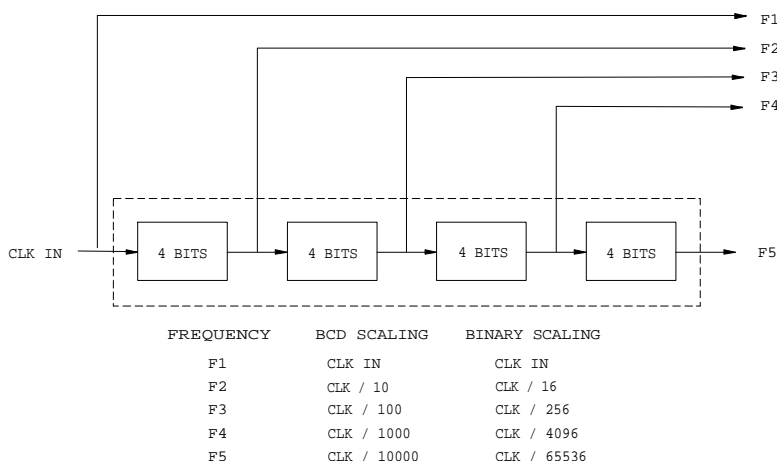

Figure 8 - CTS9513 Counter Internal Prescaler Block Diagram

MODE V (FSK) ERROR

An error in implementing the special gate function prevents the implementation of Mode V (FSK Generator). The gate level is supposed to control whether the counter is reloaded from the LOAD or HOLD register to determine the output rate generator frequency and allow switching between two frequencies to produce Frequency Shift Keying (FSK) modulation.

When programmed for Mode V, the current device Revision will reload only from the HOLD register regardless of the state of the GATE input.

This appears to be a general problem with the "special gate" function that controls reloading of the counter from the Load or Hold register depending on the state of the gate.

MODE J ERROR

The counters will not allow a count of 1 to be set in the load and/or hold registers

COUNTER SAVE ERRORS

Due to the asynchronous nature of this part (and to an extent the original AMD AM9513) we have seen errors in the saved counter data when a counter save command is issued. This occurs when the write strobe rising edge for a save command occurs simultaneously with a counter clock edge and the counter tries to save the current count while also trying to increment or decrement the counter.

The only solid solution we have found for this problem is for the bus clock to also be the master clock or to be phased locked to it in order for the timing of bus read/write cycles to be deterministic with respect to the counter clock edges.

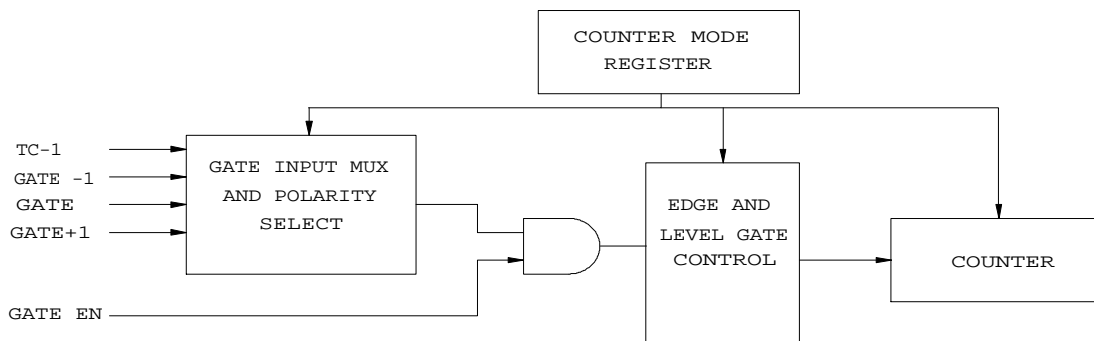

Figure 9 - CTS9513 Counter Gating Input Logic Block Diagram

SPECIFICATIONS SUBJECT TO CHANGE WITHOUT NOTICE

OPERATING MODE	A	B	C	D	E	F	G	H	I	J	K	L
CM7 (SPECIAL GATE)	0	0	0	0	0	0	0	0	0	0	0	0
CM6 (RELOAD SOURCE)	0	0	0	0	0	0	1	1	1	1	1	1
CM5 (REPITITION)	0	0	0	1	1	1	0	0	0	1	1	1
CM13-15 (GATE CONTROL)	000	LVL	EDG	000	LVL	EDG	000	LVL	EGD	000	LVL	EDG
Count to TC Once	X	X	X									
Count to TC Twice							X	X	X			
Count to TC repeatedly				X	X	X				X	X	X
Gate Input Inactive	x			x			x			x		
Count while gate active		x			x			x			x	
Count once on gate edge			x			x						
Count twice on gate edge									x			x
No Hardware retriggering	x	x	x	x	x	x	x	x	x	x	x	x
Reload from Load on TC	x	x	x	x	x	x						
Alternate Load/Hold on TC							x	x	x	x	x	x
Gate Controlled Load/Hold												
Gate Retrigger Counter												

Table 11 - Counter Modes A-L

OPERATING MODE	M	N	O	P	Q	R	S	T	U	V	W	X
CM7 (SPECIAL GATE)	1	1	1	1	1	1	1	1	1	1	1	1
CM6 (RELOAD SOURCE)	0	0	0	0	0	0	1	1	1	1	1	1
CM5 (REPITITION)	0	0	0	1	1	1	0	0	0	1	1	1
CM13-15 (GATE CONTROL)	000	LVL	EDG	000	LVL	EDG	000	LVL	EGD	000	LVL	EDG
Count to TC Once		X	X									
Count to TC Twice							X					
Count to TC repeatedly					X	X				X		
Gate Input Inactive							X			X		
Count while gate active		X			X							
Count once on gate edge			X			X						
Count twice on gate edge												
No Hardware retriggering							X			X		
Reload from Load on TC		X	X		X	X						
Alternate Load/Hold on TC												
Gate Controlled Load/Hold							X			X		
Gate Retrigger Counter		X	X		X	X						

Table 12 - Counter Modes M-X

SPECIFICATIONS SUBJECT TO CHANGE WITHOUT NOTICE

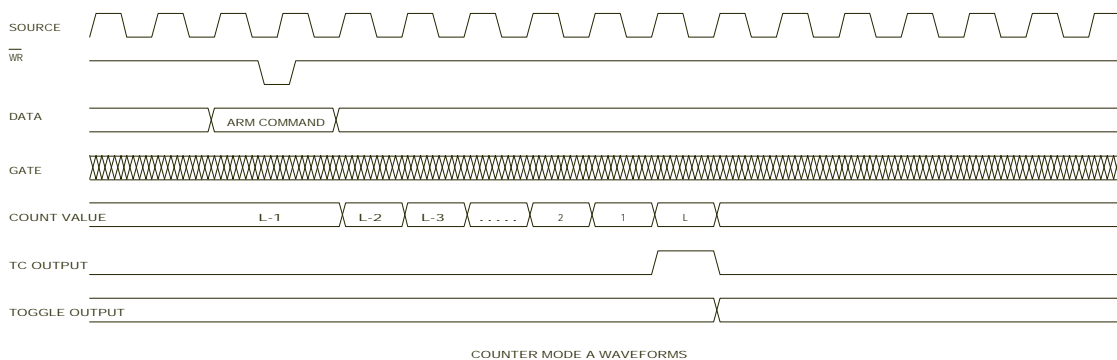

Figure 10 - CTS9513 Counter Mode A Representative Waveforms

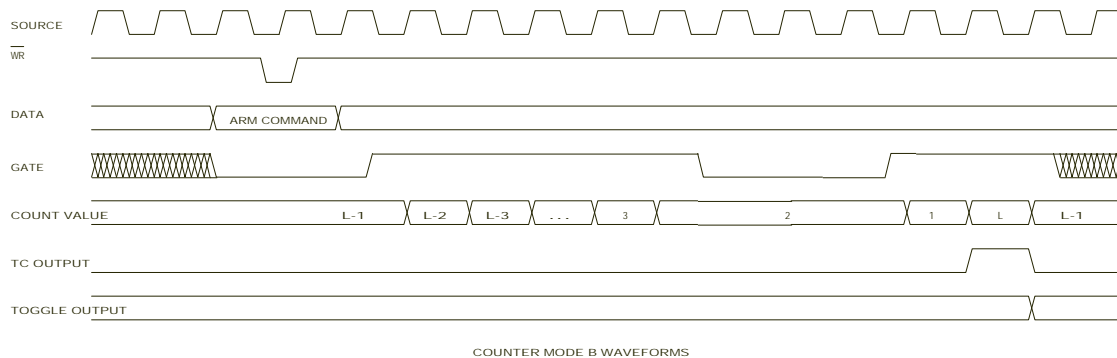

Figure 11 - CTS9513 Counter Mode B Representative Waveforms

Mode A - Software Triggered Strobe with no Gating
 As shown in Figure 10, The counter is only active after receipt of an ARM command. On reaching TC the counter automatically reloads from the Load register and disarms, awaiting the next software ARM command.

MODE B - SOFTWARE TRIGGERED STROBE WITH LEVEL GATING

In Mode B, illustrated in Figure 11 the counter is only active when both an ARM command has been received and the selected Gate line is active. The counter will halt counting when the gate line is de-asserted and resume counting when the gate line is re-asserted until the counter reaches TC. When the counter reaches TC the timer will reload from the load register and disarm automatically until a new ARM command is received.

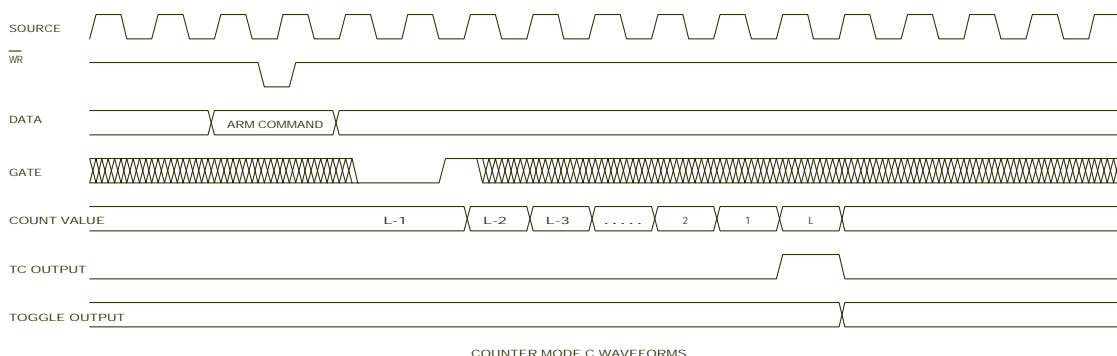

Figure 12 - CTS9513 Counter Mode C Representative Waveforms

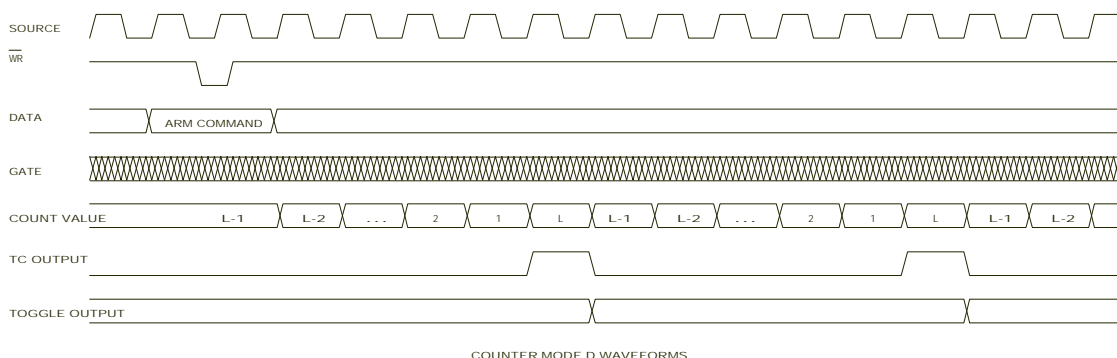

Figure 13 - CTS9513 Counter Mode D Representative Waveforms

MODE C HARDWARE TRIGGERED STROBE

In Mode C, as shown in Figure 12, the counter is active only after receipt of an ARM command and the application of a Gate edge to the selected gate line. Once a Gate edge is sensed, the counter will count until it reaches TC. Subsequent gate actions have no further effect on the counter action. The counter will remain inactive until receipt of a new ARM command and Gate.

MODE D RATE GENERATOR WITH NO HARDWARE GATING

Mode D, illustrated in Figure 13, is commonly used as a programmable frequency source as it continues to count repetitively until receipt of a DISARM command. Once ARMed, the counter counts to TC, automatically reloads the counter from the Load register and begins counting again. The waveform produced can be a square wave if the Toggle output mode is specified. The Gate line has no effect on the counter action.

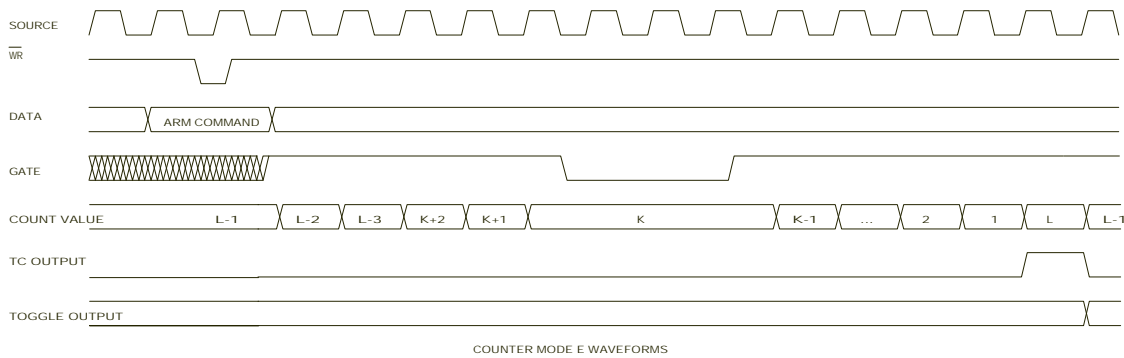

Figure 14 - CTS9513 Counter Mode E Representative Waveforms

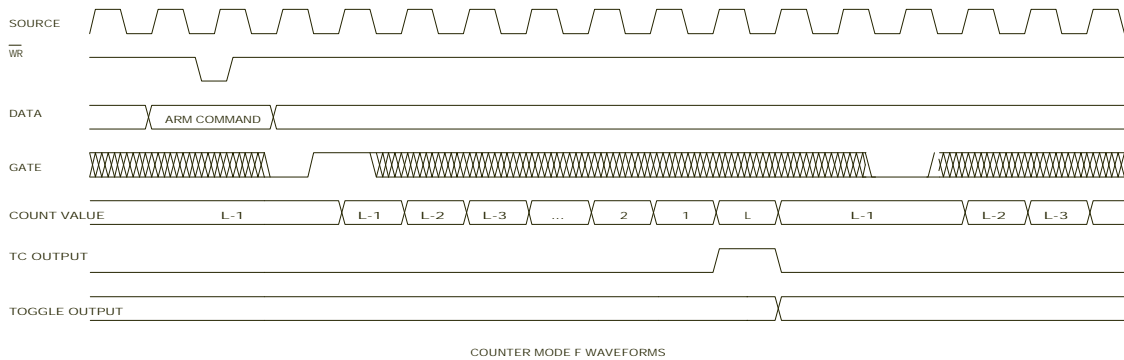

Figure 15 - CTS9513 Counter Mode F Representative Waveforms

MODE E RATE GENERATOR WITH LEVEL GATING

Mode E is similar to Mode D in that the counter will count repetitively after being ARMed and as long as the selected Gate line is asserted. As shown in Figure 14, this allows gating of the pulse train or square wave on and off from an external source via the gate line.

MODE F NON-RETRIGGERABLE ONE SHOT

Mode F is similar to Mode C with the exception that the counter may be retriggeded without receipt of a new ARM Command. As shown in Figure 15, Once the counter has been ARMed, and a valid Gate edge has been received, the counter will count once to TC and reload the counter from the Load register. It will remain inactive until receipt of another Gate edge. While counting, subsequent gate edges are disregarded.

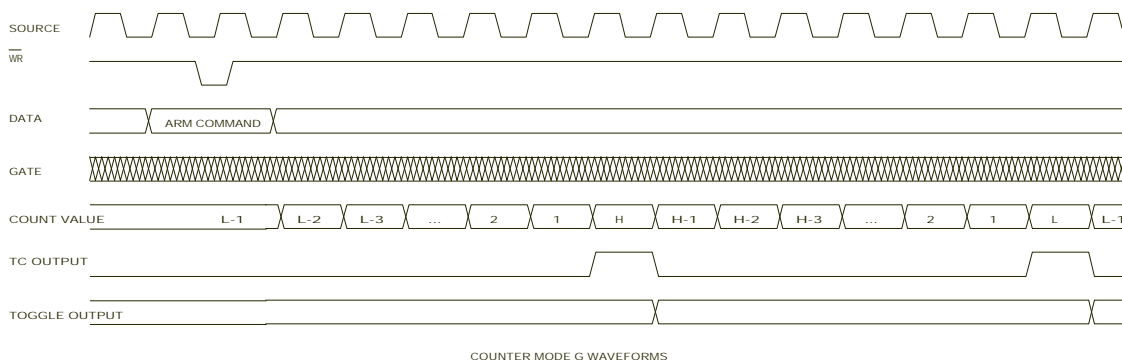

Figure 16 - CTS9513 Counter Mode G Representative Waveforms

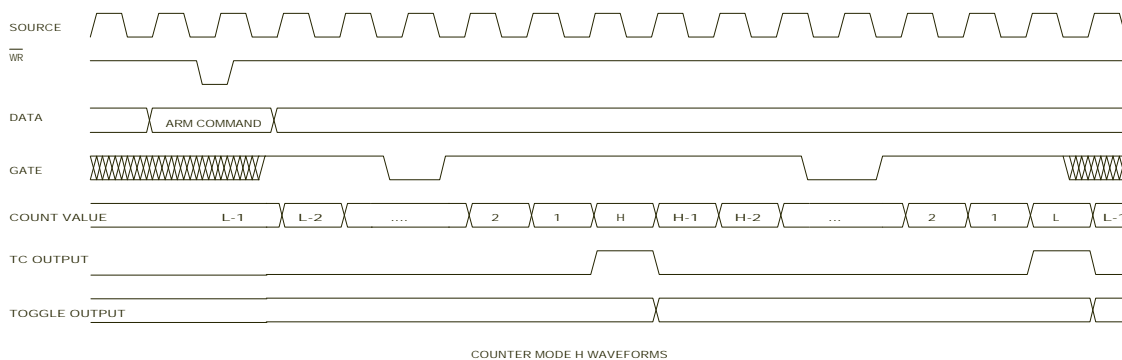

Figure 17 - CTS9513 Counter Mode H Representative Waveforms

**MODE G SOFTWARE TRIGGERED
 DELAYED PULSE ONE-SHOT**

In Mode G, once the counter has been ARMED, the counter will:

- 1 Count to TC with the Load register value
- 2 Reload itself automatically from the Hold Register.
- 3 Count to TC with the Hold Register Value
- 4 Disarm itself and reload the counter with the Load register Value.

This produces a waveform as illustrated in Figure 16 in which the counter can in TC mode produce a pair of pulses with the first pulse delay controlled by the Load count value and the delay between the pulses determined by the Hold register count.

If the Toggle Output mode is selected, the output produced is a pulse width determined by the Hold count and an initial delay determined by the Load count. This is the more common use of this mode of operation.

**MODE H SOFTWARE TRIGGERED
 DELAYED PULSE ONE-SHOT WITH
 HARDWARE GATING**

Mode H is similar to Mode G with the exception that the counter is active only after receipt of an ARM command and a valid Gate input. As shown in Figure 17 the counter counts only as long as the Gate line is asserted and suspended while the Gate line is deasserted. As in Mode G the counter counts to TC using the Load register value, reloads from the hold register and counts to a second TC. Once the counter reaches the second TC the counter disarms itself and awaits another ARM command.

This mode allows extension of either the initial delay or the delayed pulse width by use of the Gate.

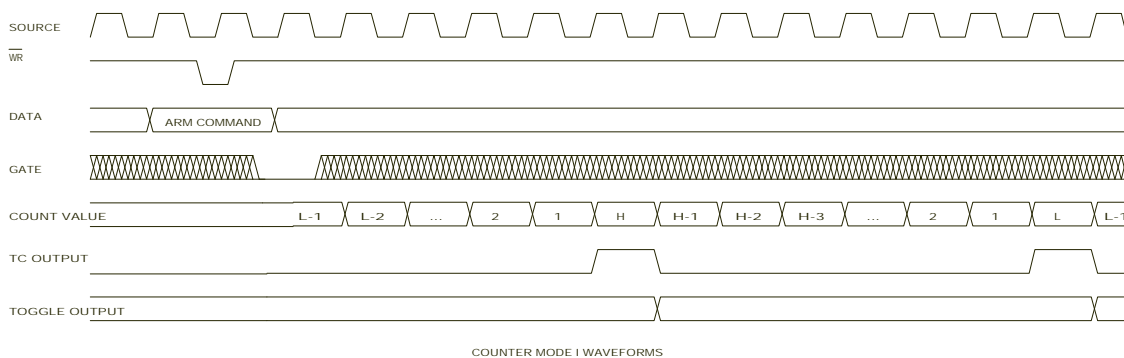

Figure 18 - CTS9513 Counter Mode I Representative Waveforms

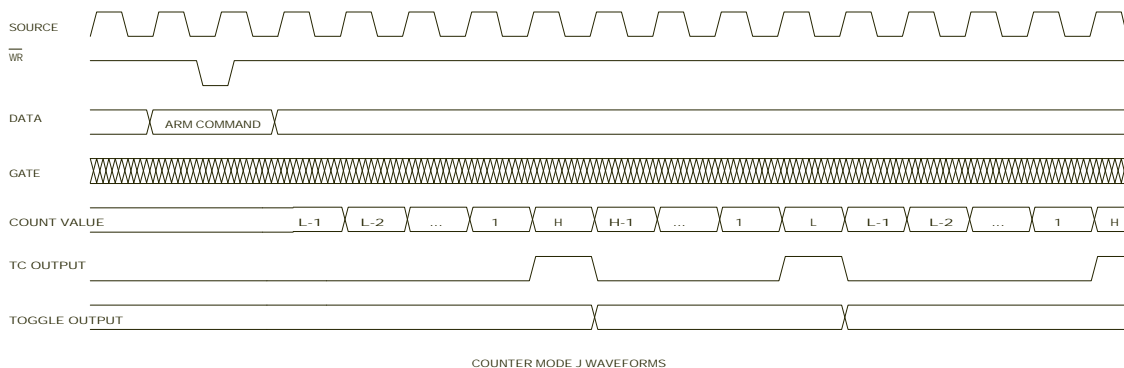

Figure 19 - CTS9513 Counter Mode J Representative Waveforms

MODE I HARDWARE TRIGGERED DELAYED PULSE STROBE

Mode I is similar to Mode G with the exception that the counter is active only after receipt of an ARM command and a valid Gate Edge. As illustrated in Figure 18, the counter will count to TC, reload from the Hold Register, count to TC then disarm itself. Once a valid Gate edge has been received the gate line has no further action on the counter.

MODE J VARIABLE DUTY CYCLE RATE GENERATOR WITH NO HARDWARE GATING

This mode is used primarily for generation of variable duty cycle waveforms. Once armed the counter will count repeatedly until disarmed. The counter will count to the first TC, reload automatically from the Hold register, count to the next TC, reload automatically from the Load register and repeat the cycle. If the toggle output mode is selected, the output will have an on(or off) time equal to the load count and off(on) time equal to the hold count. As shown in Figure 19.

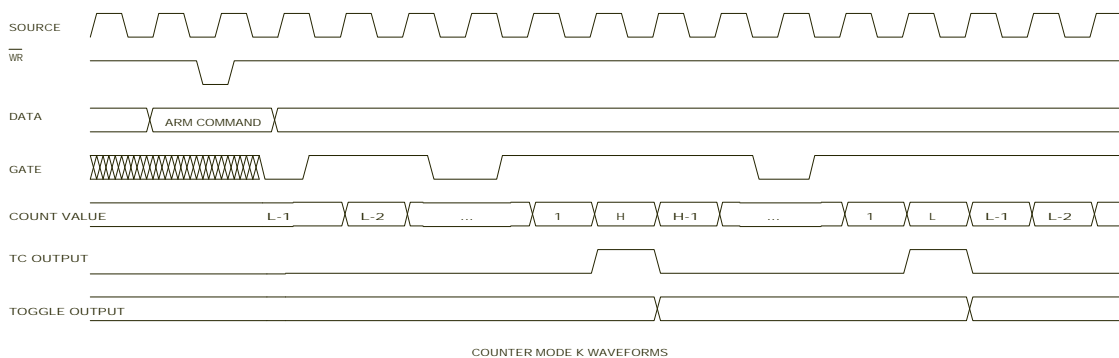

Figure 20 - CTS9513 Counter Mode K Representative Waveforms

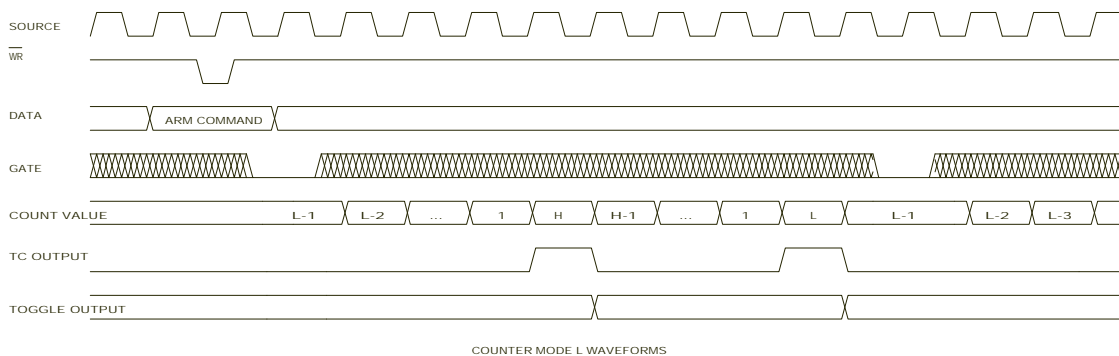

Figure 21 - CTS9513 Counter Mode L Representative Waveforms

MODE K VARIABLE DUTY CYCLE RATE GENERATOR WITH LEVEL GATING

Mode K is similar to Mode J with the exception that the counter is enabled only after being ARMed and when the selected Gate line is asserted. When the Gate line is deasserted the counter stops. This allows the gate to modulate the duty cycle of either state as illustrated in Figure 20.

MODE L HARDWARE TRIGGERED DELAYED PULSE ONE-SHOT

Mode L is used often as an externally triggered delayed pulse generator, where the delay and pulse width are both programmable. Like Modes J and K, the counter cycles through the load count, reloads from the hold at the first TC, and counts to the second TC.

Unlike Modes J and K, however the counter is only active after being ARMed and after a valid gate edge is received. As shown in Figure 21 the gate edge initiates one count cycle and is disregarded for the rest of the cycle. After one count cycle (Load and Hold) the counter stops until another gate edge is received.

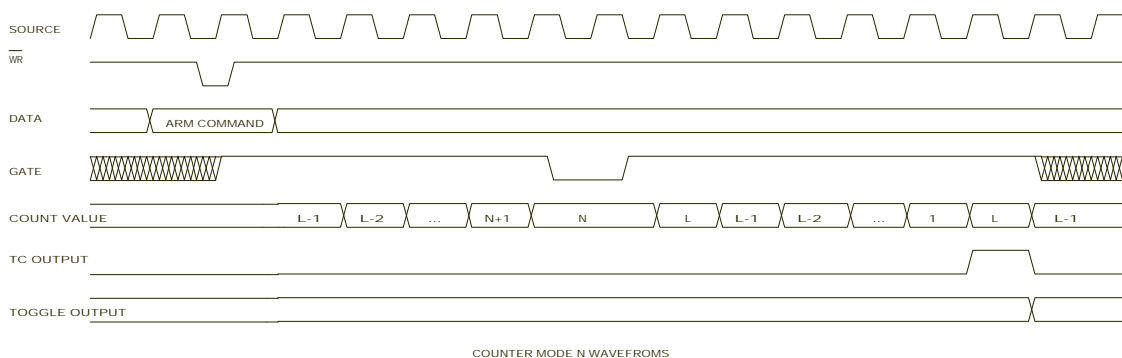

Figure 22 - CTS9513 Counter Mode N Representative Waveforms

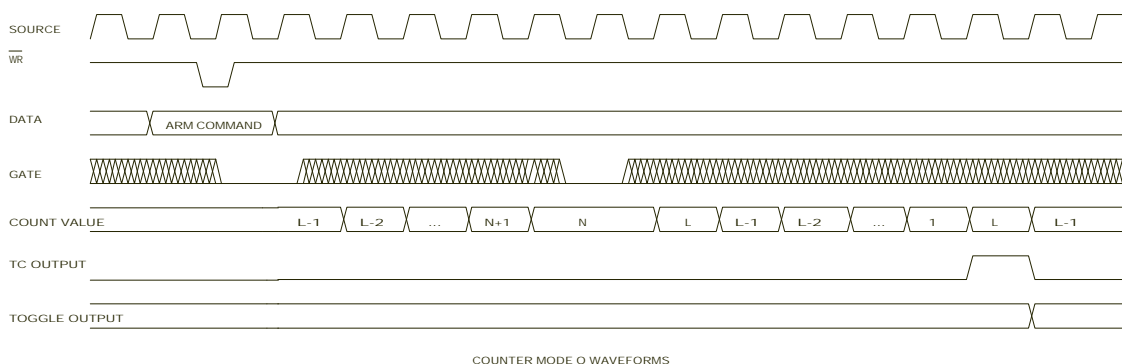

Figure 23 - CTS9513 Counter Mode O Representative Waveforms

MODE N SOFTWARE TRIGGERED STROBE WITH LEVEL GATING AND HARDWARE RETRIGGERING

In Mode N, once ARMed, the counter is active only as long as the selected Gate line is asserted. Counting begins only after the gate line is asserted after the counter is ARMed. If the Gate line remains asserted the counter will count to TC, reload automatically from the load register and disarm itself until receipt of a new ARM command. If the gate is deasserted prior to the counter reaching TC the counter will halt. When the Gate line is reasserted on a halted counter, the count value is transferred to the Hold register and the next valid count source edge will cause the counter to reload from the Load register and begin counting again, effectively retriggering the counter as shown in Figure 22.

One application of this mode is to measure the delay between two successive gate edges by reading the remainder count value from the hold register.

MODE O SOFTWARE TRIGGERED STROBE WITH EDGE GATING AND HARDWARE RETRIGGERING

Mode O is similar to Mode N in that the counter must be ARMed and a valid Gate edge must be received to start the counter. Unlike most other modes, however, each time a valid gate edge is received prior to the counter reaching TC will cause the counter to be retriggered by reloading the counter from the load register on the first valid source edge following a valid gate edge. If the counter is allowed to reach TC is automatically reloads from the Load register and disarms itself.

The counter is insensitive to gate edges while disarmed and while counting. The counter is sensitive only to a valid gate edge while counting.

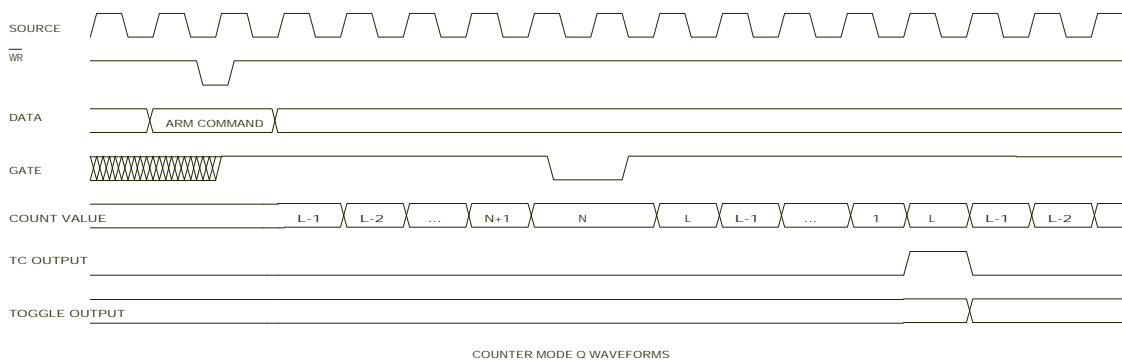

Figure 24 - CTS9513 Counter Mode Q Representative Waveforms

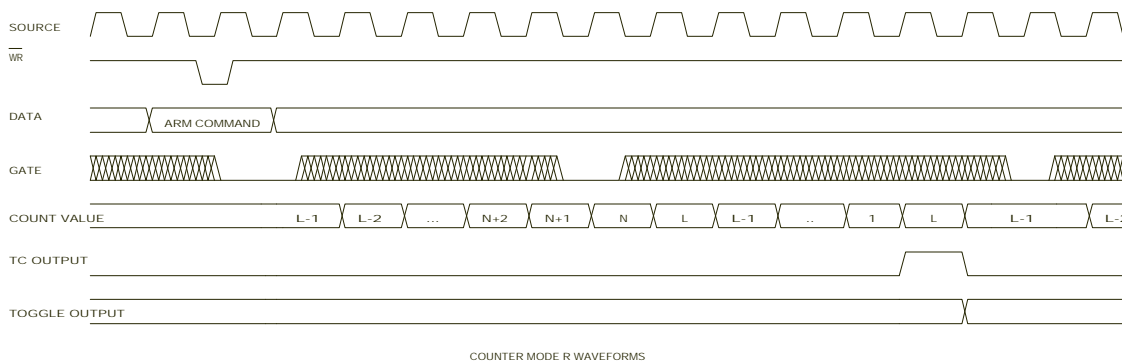

Figure 25 - CTS9513 Counter Mode R Representative Waveforms

MODE Q RATE GENERATOR WITH SYNCHRONIZATION

Mode Q provides a continuous rate generator which may be externally gated or synchronized to an external event via the Gate input. As shown in Figure 24, once an ARM command is received, the counter will continuously count to TC, reload the Load register and repeat as long as the Gate line is asserted. While the Gate line is deasserted the counter is inhibited. On the active going edge of the gate signal the counter is reloaded from the Load register, resetting the counter and resume counting on the second valid source edge following the Gate edge.

MODE R RETRIGGERABLE ONE-SHOT

Mode R, as shown in Figure 25, begins counting only after receipt of an ARM command and a valid active Gate edge. The counter will count once to TC and stop. The counter will remain inactive until receipt of a subsequent valid Gate edge.

If a valid Gate Edge is received prior to the counter reaching TC the counter value will be saved in the Hold register and the counter reloaded from the Load register, retriggering or resetting the counter. The counter is insensitive to the Gate level and gate actions do not inhibit the counter as in Mode Q.

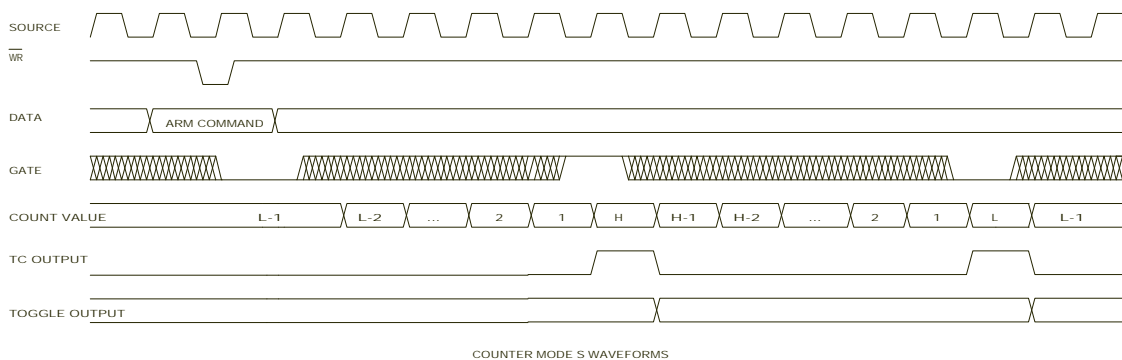

Figure 26 - CTS9513 Counter Mode S Representative Waveforms

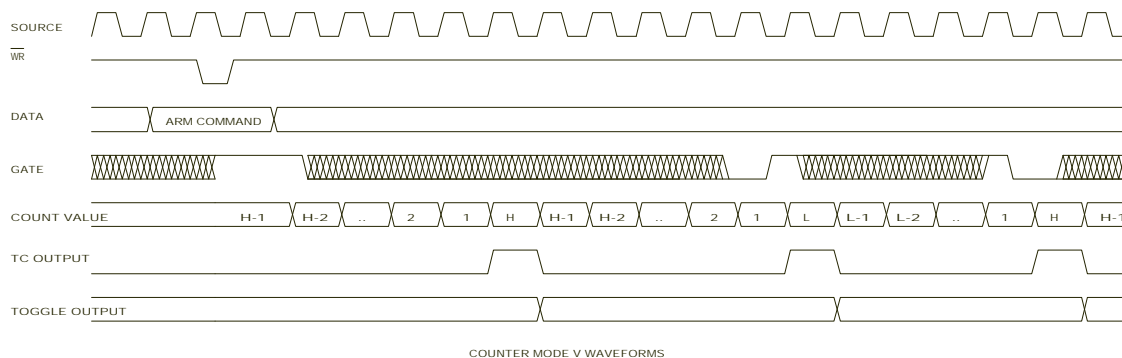

Figure 27 - CTS9513 Counter Mode V Representative Waveforms

MODE S GATE CONTROLLED STROBE

In Mode S, once ARMed the counter will count to TC twice and disarm. During this time the State of the Gate line determines whether the counter is loaded from the Load or Hold Register. The Gate line does not affect or initiate the counter in this Mode. Its only action is a level sensitive selection of the Load or Hold Register as a counter reload source.

As shown in Figure 26, at each TC in the cycle, if the Gate line is high, the counter will be reloaded from the Hold Register. If it is Low the counter is reloaded from the Load Register.

MODE V FREQUENCY SHIFT KEYING

Mode V is similar to mode S in that the Gate line act to select which register the counter is reloaded from, but counts continuously once armed. If the Toggled output is used, the output may be used to switch between two frequencies determined by the Load and Hold Count values and the state of the Gate line as shown in Figure 27. This is used in Frequency Shift Keying (FSK) applications.

NOTE: This mode does not function correctly in current devices. Please see the ERRATA section for more information

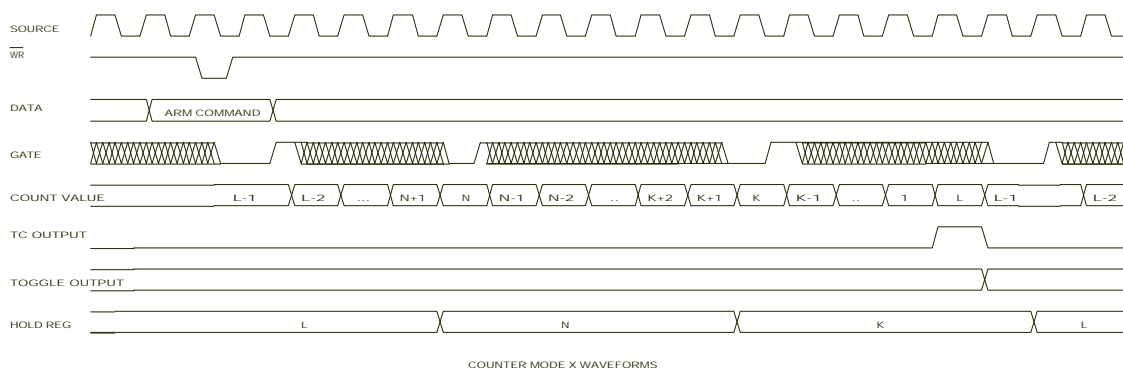

Figure 28 - CTS9513 Counter Mode X Representative Waveforms

MODE X HARDWARE SAVE

Mode X is a hardware edge triggered strobe counter with the capability of reading the counter value without interrupting the count.

As shown in Figure 28, once the counter is ARMED a valid gate edge starts the counter. Once triggered the counter will count to TC regardless of the state of the Gate line. Gate edges received prior to TC will store the current count in the Hold register. Once the counter has reached TC the counter will stop until a subsequent gate edge is received. Gate edges applied to an unarmed counter have no effect.

Symbol	Specification	Min	Max	Units
V_{ILT}	TTL Input LOW Level		0.8	Volts
V_{IHT}	TTL Input HIGH Level	2		Volts
V_{ILC}	X2 Input LOW Level		1.5	Volts
V_{IHC}	X2 Input HIGH Level	$V_{DD} - 1.5$		Volts
V_{OL}	Output LOW Level @ $I_{OL} = 4mA$		0.4	Volts
V_{OH}	Output HIGH Level @ $I_{OL} = 4mA$	2.4		Volts
I_Z	Input Leakage Current	-10	10	μA
I_{DD}	Supply Current /No Load / $F_{OSC} = 7MHz$		20	mA
I_{DDS}	IDD Static		10	μA
C_{IN}	Pin Capacitance		10	pF

Table 12 - CTS9513 Electrical Characteristics

SPECIFICATIONS SUBJECT TO CHANGE WITHOUT NOTICE

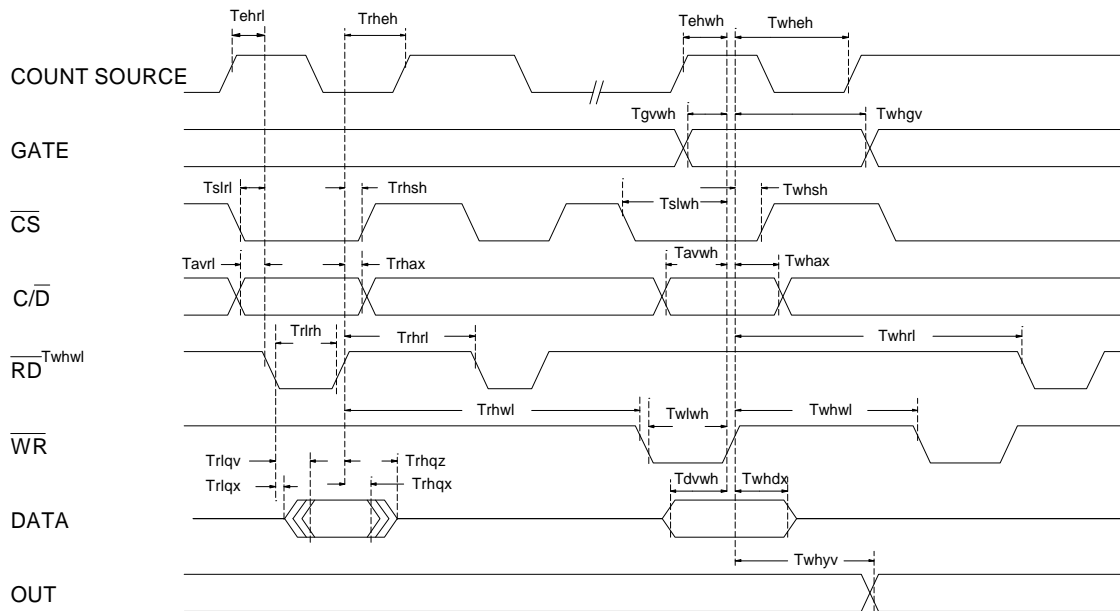

Figure 30 - Bus Timing Diagram

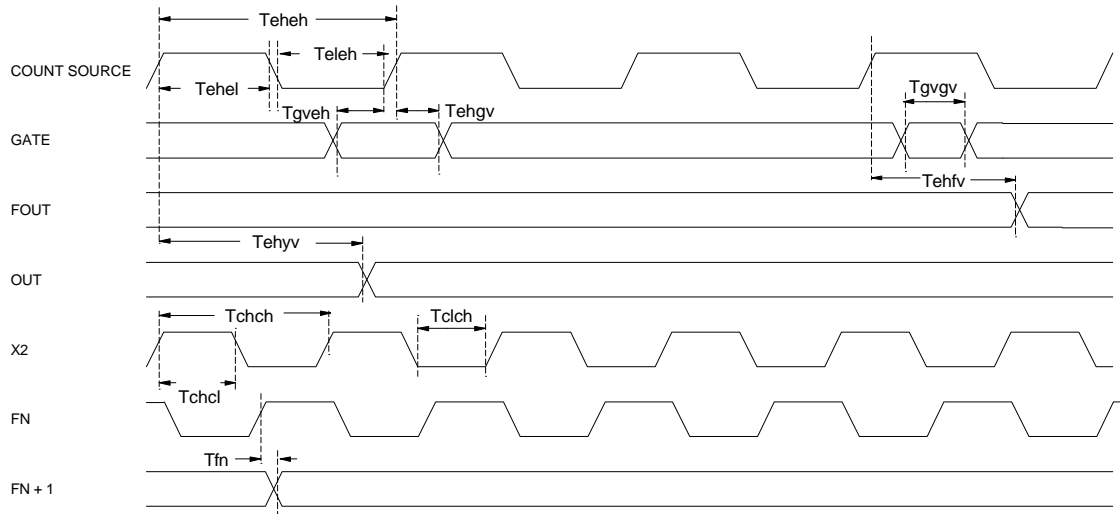

Figure 31 - Counter Timing Diagram

SPECIFICATIONS SUBJECT TO CHANGE WITHOUT NOTICE

Param	Description	Figure	Min	Typ	Max
Tavrl	C/D Valid to Read Low	2		15	
Tavwh	C/D Valid to Write High	2		30	
Tdvwh	Data In Valid to Write High	2		40	
Tehrl	Count Source High to Read (setup time) Note 2,7	2		100	
Tehwh	Count Source High to Write High (setup time) Note 3,7	2		50	
Tgvwh	Gate valid to Write High Note 3,10	2		0	
Trhax	Read High to C/D don't Care	2		0	
Trheh	Read High to Count Source High Note 4,7	2		0	
Trhqx	Read High to Data Out Invalid	2		20	
Trhqz	Read High to Data Out Hi-Z (Bus Release Time)	2		40	
Trhrl	Read High to Read Low (Read Recovery Time)	2		500	
Trhsh	Read High to CS High Note 12	2	0		
Trhwl	Read High to Write Low (Read Recovery Time)	2		500	
Trlqv	Read Low to Data Out Valid	2		50	
Trlqx	Read Low to Data Bus Driven (Bus Drive Time)	2		20	
Trlrh	Read Low to Read High (Read Pulse Duration) Note 12	2		80	
Tslrl	CS Low to Read Low Note 12	2		10	
Tslwh	CS Low to Write High Note 12	2		80	
Twhax	Write High to C/D Don't Care	2		0	
Twhdx	Write High to Data In Don't Care	2		0	
Tweh	Write High to Count Source High Note 5, 7, 14, 15	2		200	
Twhgv	Write High to Gate valid Note 5, 10, 14	2		200	
Twhrl	Write High to Read Low (Write Recovery Time) Note 16	2		500	
Twhsh	Write High to CS High Note 12	2		0	
Twhwl	Write High to Write Low (Write Recovery Time) Note 16	2		500	
Twhyv	Write High to Out Valid Note 6, 14	2		300	
Twlwh	Write Low to Write High (Write Pulse Duration) Note 12	2		75	

Table 14 - Bus Timing Specifications

NOTES

- Any Input transition that occurs before this minimum setup requirement will be reflected in the contents read from the status register
- Any Input transition that occurs before this minimum setup requirement will act on the counter before the execution of the operation initiated by the write and the counter may be off by one count
- Any input transition that occurs after this minimum hold time is guaranteed to not influence the contents read from the status register on the current read operation
- Any input transition that occurs after this minimum hold time is guaranteed to be seen by the counter as occurring after the action initiated by the write operation and the counter may be off by one count.
- This parameter applies to cases where the write operation causes a change in the output bit.
- The enabled count source is one of F1-F5, TCN-1 SRC1-SRC5 or GATE1-GATE 5, as selected in the applicable Counter Mode register. The timing diagram assumes the counter counts on rising source edges. The timing specifications are the same for falling-edge counting.
- This parameter applies to edge gating (CM15-CM13=110 or 111) and gating when both CM7=1 and CM15-CM13≠000. This parameter represents the minimum GATE pulse width needed to ensure that the pulse initiates counting or counter reloading.
- This parameter applies to both edge and level gating (CM15-CM13=001 through 111 and CM7 =0). This parameter represents the minimum setup or hold times to ensure that the Gate input is seen at the intended level on the active source edge and the counter may be off by one count.
- This parameter assumes that the GATENA input is unused (16-bit bus mode) or is tied high. In cases where the GATENA input is used, this timing specification must be met by both the GATE and GATENA inputs.
- Signals F1-F5 cannot be directly monitored by the user. The phase difference between these signals will manifest itself by causing counters using two different F signals to count at different times on nominally simultaneous transitions in the F signals. F1=X2.
- This timing specification assumes that CS is active whenever RD or WR are active. CS may be held active indefinitely.
- This parameter assumes X2 is driven from an external gate with a square wave.
- This parameter assumes that the write operation is to the command register.
- This timing specification applies to single-action commands only (e.g. LOAD, ARM, SAVE, etc.) For double action commands such as LOAD AND ARM and DISARM AND SAVE, TWHEH minimum = 700ns.
- In short data write mode, TWHRL and TWHWL minimum = 1000 ns.
- This parameter applies to the hardware retrigger/save modes N, O, Q, R, and X (CM7 = 1 and CM15-CM13<>000). This parameter ensures that the gating pulse initiates a hardware retrigger/save operation.
- This parameter applies to hardware load source select modes S and V (CM7 = 1 and CM15-CM13=000). This parameter represents the minimum hold time to ensure that the GATE input selects the correct load source on the active source edge.

SPECIFICATIONS SUBJECT TO CHANGE WITHOUT NOTICE

Param	Description	Fig	Min	Typ	Max	Unit	Note
Tchch	X2 Period	1		50		nS	
Tchd	X2 High Pulse Width	1		25		nS	
Tdch	X2 Low Pulse Width	1		25		nS	
Teheh	Count Source High to Count Source High (max count freq)	1		50		nS	
TeheL	Count Source Pulse Duration - High	1		25		nS	
Tehev	Count Source high to FOUT Valid	1			200	nS	
Tehev	Level Gating Hold Time (Note 1)	1		20		nS	
Tehev	Count Source High to Out Valid	1			150	nS	
TeheL	Count Source Pulse Duration - Low	1		25		nS	
Tfn	Prescaler Clock Skew	1		40		nS	
Tgveh	Level Gating Setup Time (Note 1)	1		40		nS	
Tgvv	Gate Pulse Duration (Note 2)	1		70		nS	

Table 15 - Counter Timing Specifications - To Accompany Figure 31

Notes

- 1 This parameter applies to both level and edge gating , representing the minimum setup or hold times to ensure that the Gate input is seen at the intended level on the active source edge or the counter may be off one count.
- 2 This parameter applies to both level and edge gating, representing the minimum gate pulse width needed to ensure the pulse initiates counter gating or reloading.

SPECIFICATIONS SUBJECT TO CHANGE WITHOUT NOTICE

Availability

Availability of the CTS9513AxI-2 is stock to 6 weeks for any production quantity. Scheduled delivery orders for periods of up to 12 months are welcome.

Pricing

Preliminary suggested end user pricing for the CTS9513 is available on our web site. For distributor or OEM pricing please contact the factory. CTS reserves the right to change these prices at any time without prior notification.

SPECIFICATIONS SUBJECT TO CHANGE WITHOUT NOTICE

Sales Offices

Celeritous Technical Services
3308 34th St
Lubbock, TX 79410
800.687.6510
+1.806.793.0708
+1.806.793.0710 FAX

Distributors

Patriot Components
544 R. Salem St.
Wakefield, MA
+1.781-245.7201
+1.781.245.7202 FAX

DISCLAIMERS

This data sheet describes specifications for a device under development. Celeritous Technical Services (CTS) reserves the right to make changes in these specifications at any time without prior notice.

Although the information contained in these specifications is believed to be true and accurate at the time of publication, CTS reserves the right to change specifications at any time without prior notification.

Celeritous Technical Services does not assume any liability arising out of the application or use of any of its products described herein.

Names, part numbers, trademarks and copyrights of other devices referenced in these specifications belong to their respective owners.

Celeritous Technical Services' products are not designed, warranted or authorized for use in any life support devices or systems where failure of a component may lead to severe injury or death. CTS is not liable for any direct or indirect damages or injury caused through such use.

CTS does not assume any liability or responsibility arising out of the use or application of any of its products, nor does it grant any license or rights.

Additional Documentation

For additional, full size, latest updates and more detailed documentation, visit our Web Site at:

<http://www.celeritous.com>

This data sheet and others are available for download in Acrobat format. Acrobat viewers are also available for download.

SPECIFICATIONS SUBJECT TO CHANGE WITHOUT NOTICE