

# PTF 10125

## 135 Watts, 1.4–1.6 GHz

### GOLDMOS™ Field Effect Transistor

#### Description

The PTF 10125 is an internally matched, common source N-channel enhancement-mode lateral MOSFET intended for linear driver and final applications from 1.4 to 1.6 GHz, such as DAB/DRB. It is rated at 135 watts minimum power output. Nitride surface passivation and full gold metallization ensure excellent device lifetime and reliability.

- **INTERNALLY MATCHED**
- **Performance at 1.5 GHz, 28 V**
  - Output Power = 135 Watts Min
  - Power Gain = 12.5 dB Typ
- **Full Gold Metallization**
- **Silicon Nitride Passivated**
- **Back Side Common Source**
- **Excellent Thermal Stability**
- **100% Lot Traceability**

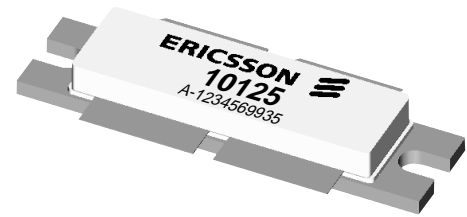
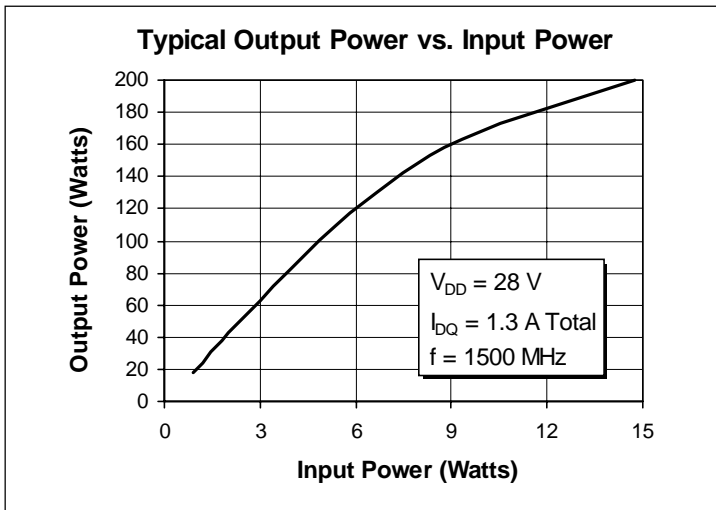

Package 20250

#### RF Specifications (100% Tested)

Characteristic	Symbol	Min	Typ	Max	Units
<b>Gain</b> ( $V_{DD} = 28\text{ V}$ , $P_{OUT} = 30\text{ W}$ , $I_{DQ} = 1.3\text{ A Total}$ , $f = 1.50, 1.55\text{ GHz}$ )	$G_{ps}$	11.5	12.5	—	dB
<b>Power Output at 1 dB Compression</b> ( $V_{DD} = 28\text{ V}$ , $I_{DQ} = 1.3\text{ A Total}$ , $f = 1.50, 1.55\text{ GHz}$ )	P-1dB	135	150	—	Watts
<b>Drain Efficiency</b> ( $V_{DD} = 28\text{ V}$ , $P_{OUT} = 135\text{ W}$ , $I_{DQ} = 1.3\text{ A Total}$ , $f = 1.5\text{ GHz}$ )	$\eta_D$	35	40	—	%
<b>Load Mismatch Tolerance</b> ( $V_{DD} = 28\text{ V}$ , $P_{OUT} = 67.5\text{ W}$ , $I_{DQ} = 1.3\text{ A Total}$ , $f = 1.5\text{ GHz}$ —all phase angles at frequency of test)	$\Psi$	—	—	10:1	—

All published data at  $T_{CASE} = 25^\circ\text{C}$  unless otherwise indicated.

## Electrical Characteristics (100% Tested—characteristics, conditions and limits shown per side)

Characteristic	Conditions	Symbol	Min	Typ	Max	Units
Drain-Source Breakdown Voltage	$V_{GS} = 0\text{ V}, I_D = 100\text{ mA}$	$V_{(BR)DSS}$	65	—	—	Volts
Zero Gate Voltage Drain Current	$V_{DS} = 28\text{ V}, V_{GS} = 0\text{ V}$	$I_{DSS}$	—	—	5.0	mA
Gate Threshold Voltage	$V_{DS} = 10\text{ V}, I_D = 150\text{ mA}$	$V_{GS(th)}$	3.0	—	5.0	Volts
Forward Transconductance	$V_{DS} = 10\text{ V}, I_D = 6\text{ A}$	$g_{fs}$	2.0	4.0	—	Siemens

## Maximum Ratings

Parameter	Symbol	Value	Unit
Drain-Source Voltage <sup>(1)</sup>	$V_{DSS}$	65	Vdc
Gate-Source Voltage <sup>(1)</sup>	$V_{GS}$	$\pm 20$	Vdc
Operating Junction Temperature	$T_J$	200	$^{\circ}\text{C}$
Total Device Dissipation Above 25 $^{\circ}\text{C}$ derate by	$P_D$	440 2.51	Watts W/ $^{\circ}\text{C}$
Storage Temperature Range	$T_{STG}$	-40 to +150	$^{\circ}\text{C}$
Thermal Resistance ( $T_{CASE} = 70^{\circ}\text{C}$ )	$R_{\theta JC}$	0.39	$^{\circ}\text{C}/\text{W}$

<sup>(1)</sup>per side

## Typical Performance

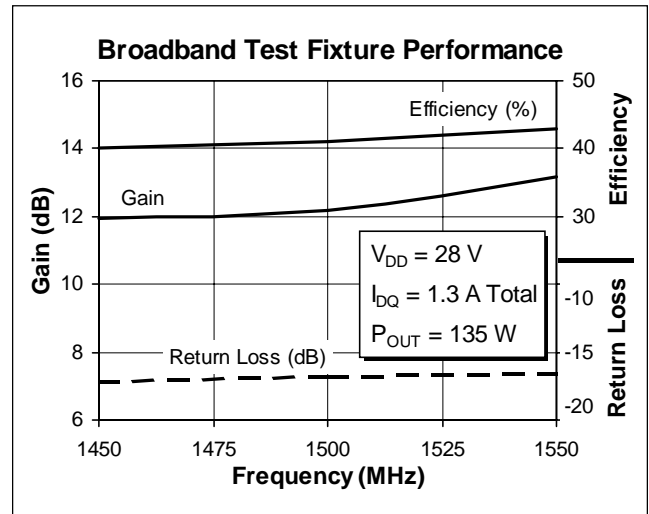
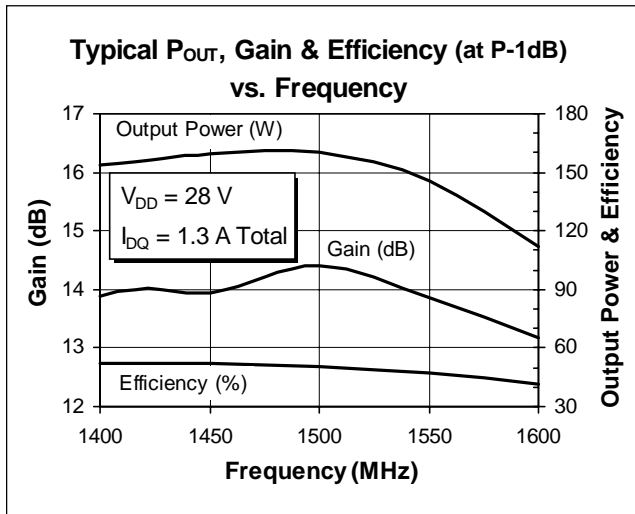

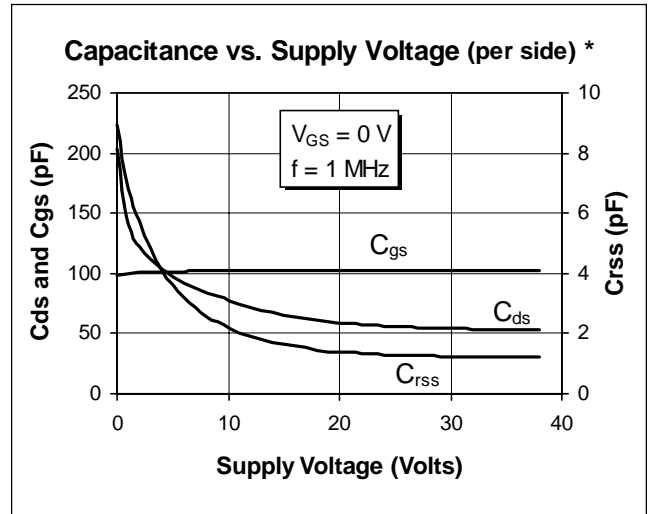
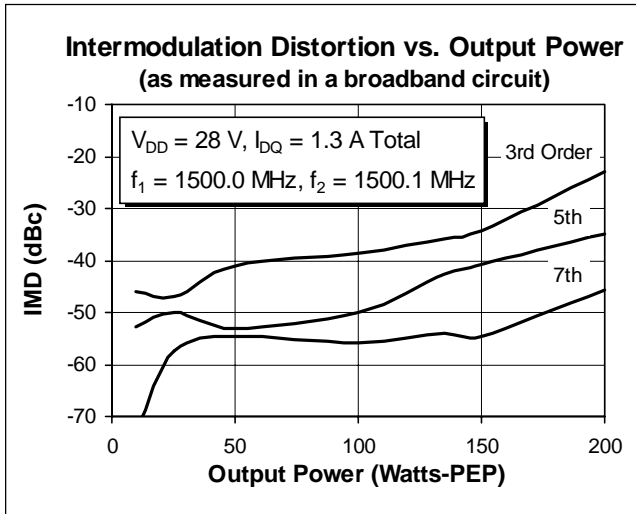
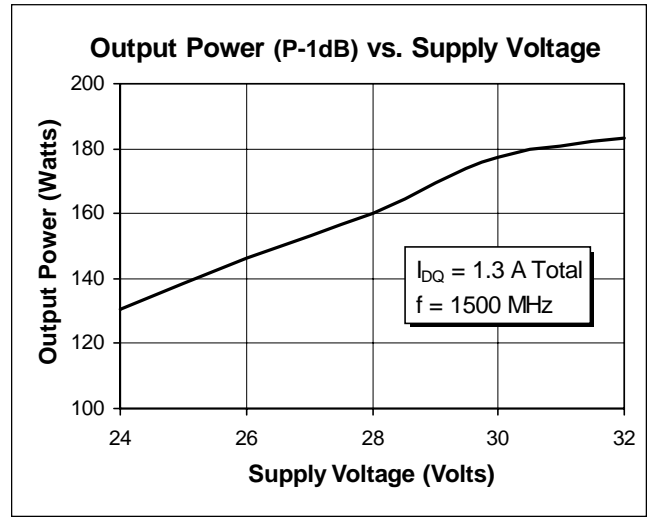
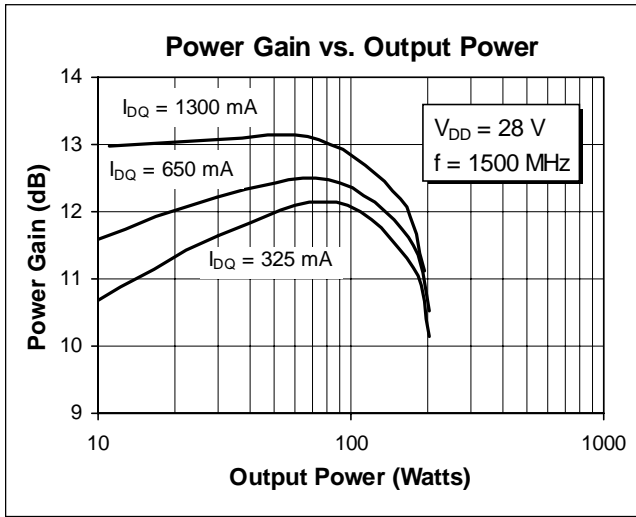

\* This part is internally matched. Measurements of the finished product will not yield these results.

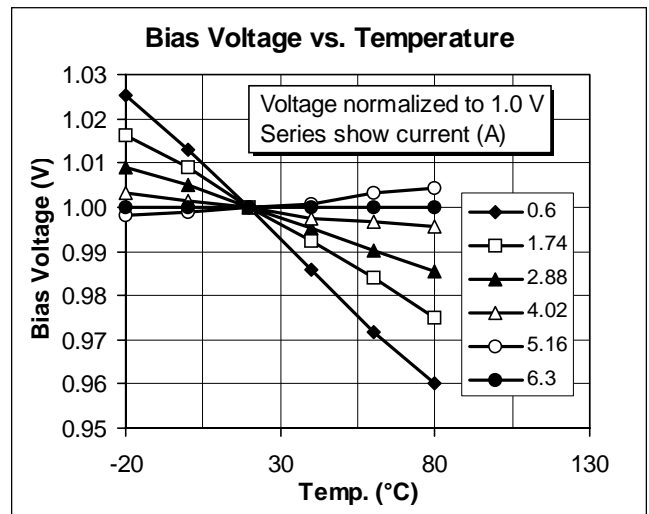
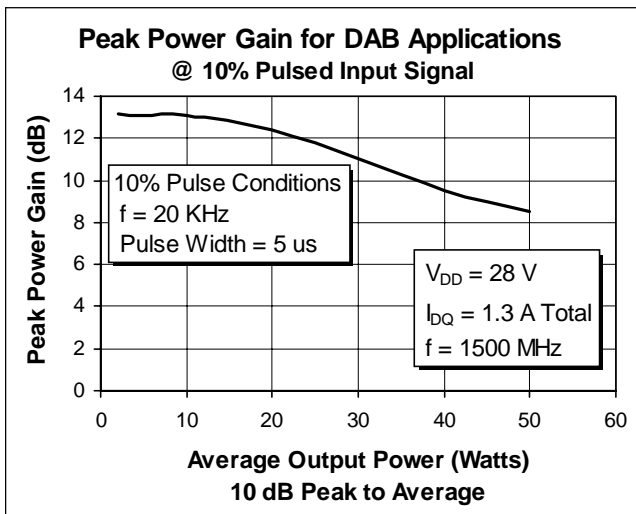

# PTF 10125



## Impedance Data

( $V_{DD} = 28\text{ V}$ ,  $P_{OUT} = 135\text{ W}$ ,  
 $I_{DQ} = 1.3\text{ A Total}$ )

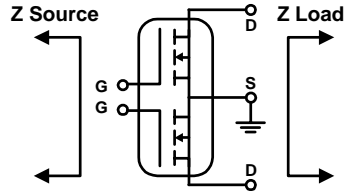

Frequency GHz	Z Source $\Omega$		Z Load $\Omega$	
	R	jX	R	jX
1400	2.85	-4.23	2.60	-2.46
1450	4.16	-4.36	2.36	-2.53
1500	4.58	-3.30	2.04	-2.48
1550	4.02	-0.83	1.63	-2.52
1600	3.41	0.37	1.27	-2.08

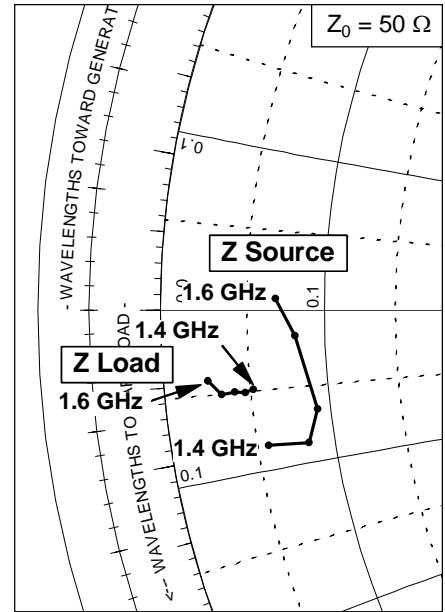

**Test Circuit**

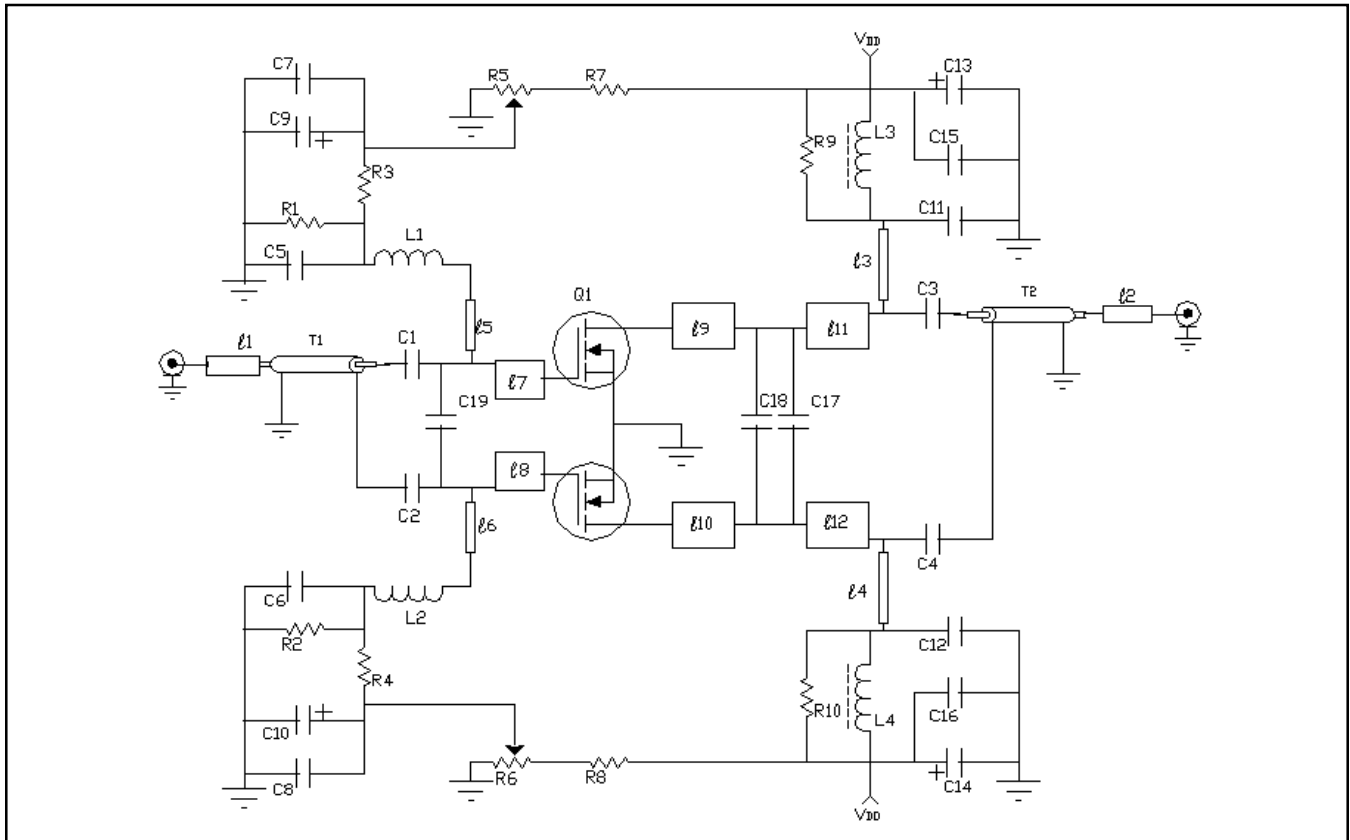

*Test Circuit Block Diagram for  $f = 1.5$  GHz*

Q1	PTF 10125	LDMOS RF Transistor	L1, L2	2.7 nH SMT Coil	
l1, l2		Microstrip 50 $\Omega$	L3, L4	4 mm SMT Ferrite Bead	
l3, l4	.25 $\lambda$ @ 1.5 GHz	Microstrip 70 $\Omega$	R1, R2, R3, R4	220 $\Omega$ Chip Resistor	K1206
l5, l6	.08 $\lambda$ @ 1.5 GHz	Microstrip 80 $\Omega$	R5, R6	2K SMT Potentiometer	
l7, l8	.138 $\lambda$ @ 1.5 GHz	Microstrip 9.5 $\Omega$	R7, R8	10 $\Omega$ Chip Resistor	K1206
l9, l10	.096 $\lambda$ @ 1.5 GHz	Microstrip 7.7 $\Omega$	R9, R10	1 $\Omega$ Chip Resistor	K1206
l11, l12	.045 $\lambda$ @ 1.5 GHz	Microstrip 7.7 $\Omega$	T1, T2	50 $\Omega$ Coaxial Balun	
C1, C2, C3, C4, C7,					
C8, C11, C12	13 pF Chip Cap	ATC 100 B			
C5, C6, C15, C16	0.1 $\mu$ F Chip Cap	K1206			
C9, C10, C13, C14	10 $\mu$ F SMT Tantalum Cap				
C17, C19	2.0 pF Chip Cap	ATC 100 B			
C18	0.3 pF Chip Cap	ATC 100 B			
			Circuit Board	.028" Dielectric Thickness, $\epsilon_r = 4.0$ , AlliedSignal, G200, 2 oz. copper	

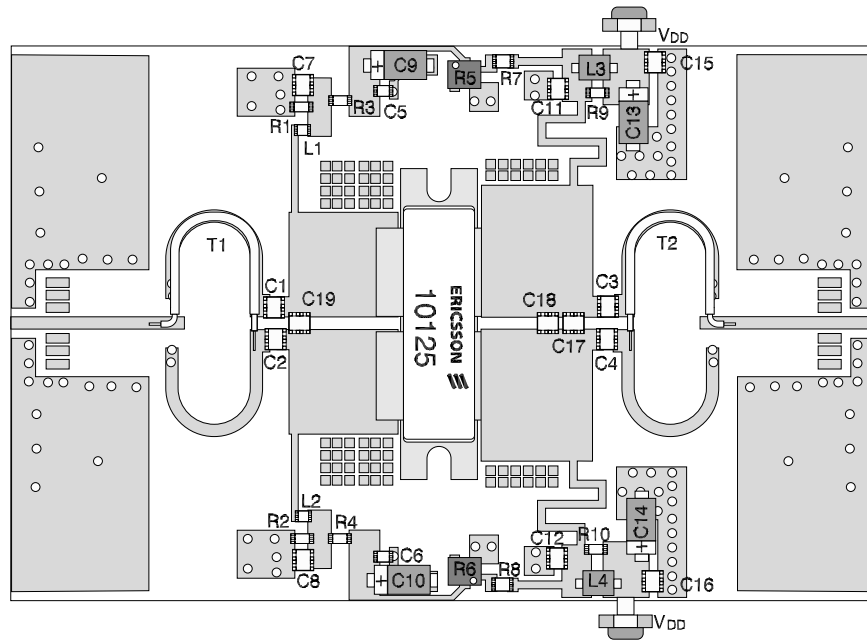

Parts Layout (not to scale)

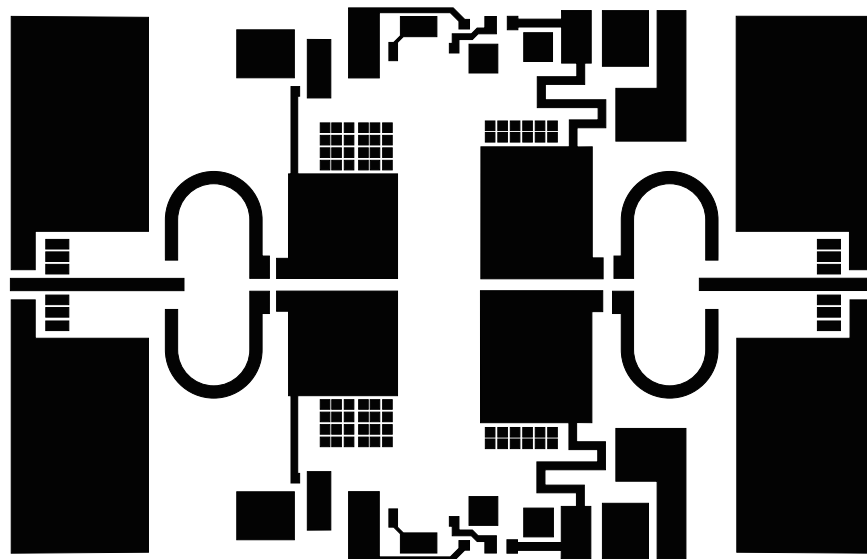

Artwork (1 inch )