

PTF 10120

120 Watts, 1.8–2.0 GHz

GOLDMOS™ Field Effect Transistor

Description

The PTF 10120 is an internally matched common source N-channel enhancement-mode lateral MOSFET intended for CDMA and TDMA applications from 1.8 to 2.0 GHz. It is rated at 120 watts power output. Nitride surface passivation and full gold metallization ensure excellent device lifetime and reliability.

- **INTERNALLY MATCHED**
- **Guaranteed Performance at 1.99 GHz, 28 V**
- Output Power = 120 Watts Min
- Power Gain = 11 dB Typ
- **Full Gold Metallization**
- **Silicon Nitride Passivated**
- **Back Side Common Source**
- **Excellent Thermal Stability**
- **100% Lot Traceability**

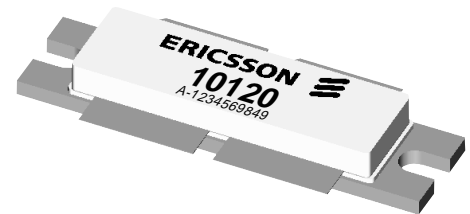
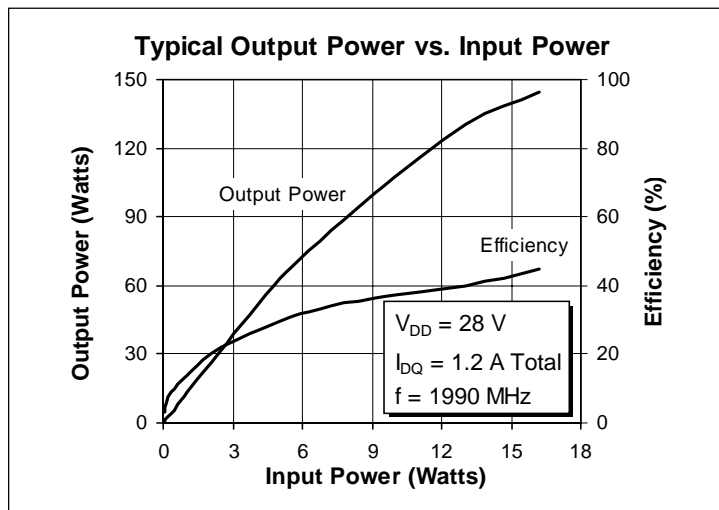

Package 20250

RF Specifications (100% Tested)

Characteristic	Symbol	Min	Typ	Max	Units
Gain ($V_{DD} = 28\text{ V}$, $P_{OUT} = 30\text{ W}$, $I_{DQ} = 1.2\text{ A Total}$, $f = 1.99\text{ GHz}$)	G_{ps}	10	11	—	dB
Power Output at 1 dB Compression ($V_{DD} = 28\text{ V}$, $I_{DQ} = 1.2\text{ A Total}$, $f = 1.99\text{ GHz}$)	P-1dB	120	—	—	Watts
Drain Efficiency ($V_{DD} = 28\text{ V}$, $P_{OUT} = 120\text{ W}$, $I_{DQ} = 1.2\text{ A Total}$, $f = 1.99\text{ GHz}$)	η_D	—	40	—	%
Load Mismatch Tolerance ($V_{DD} = 28\text{ V}$, $P_{OUT} = 60\text{ W}$, $I_{DQ} = 1.2\text{ A Total}$, $f = 1.99\text{ GHz}$ —all phase angles at frequency of test)	Ψ	—	—	10:1	—

All published data at $T_{CASE} = 25^\circ\text{C}$ unless otherwise indicated.

Electrical Characteristics (100% Tested—characteristics, conditions and limits shown per side)

Characteristic (per side)	Conditions	Symbol	Min	Typ	Max	Units
Drain-Source Breakdown Voltage	$V_{GS} = 0\text{ V}, I_D = 100\text{ mA}$	$V_{(BR)DSS}$	65	—	—	Volts
Zero Gate Voltage Drain Current	$V_{DS} = 28\text{ V}, V_{GS} = 0\text{ V}$	I_{DSS}	—	—	5.0	mA
Gate Threshold Voltage	$V_{DS} = 10\text{ V}, I_D = 150\text{ mA}$	$V_{GS(th)}$	3.0	—	5.0	Volts
Forward Transconductance	$V_{DS} = 10\text{ V}, I_D = 2\text{ A}$	g_{fs}	—	4.0	—	Siemens

Maximum Ratings

Parameter	Symbol	Value	Unit
Drain-Source Voltage ⁽¹⁾	V_{DSS}	65	Vdc
Gate-Source Voltage ⁽¹⁾	V_{GS}	±20	Vdc
Operating Junction Temperature	T_J	200	°C
Total Device Dissipation at Above 25°C derate by	P_D	440 2.51	Watts W/°C
Storage Temperature Range	T_{STG}	-40 to +150	°C
Thermal Resistance ($T_{CASE} = 70^\circ\text{C}$)	$R_{\theta JC}$	0.39	°C/W

⁽¹⁾ per side

Typical Performance

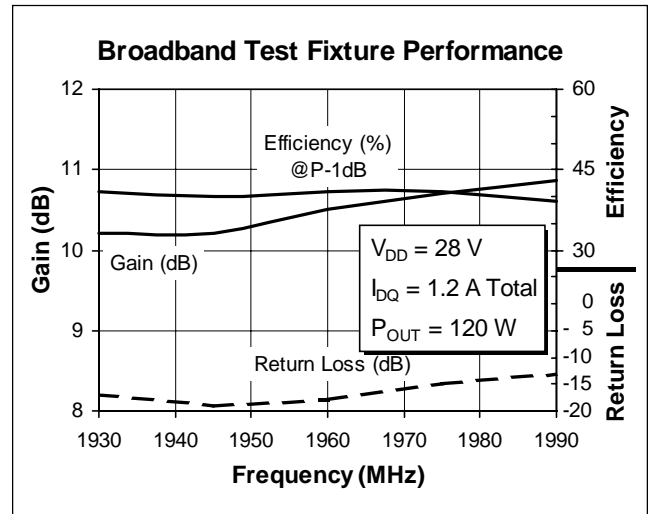
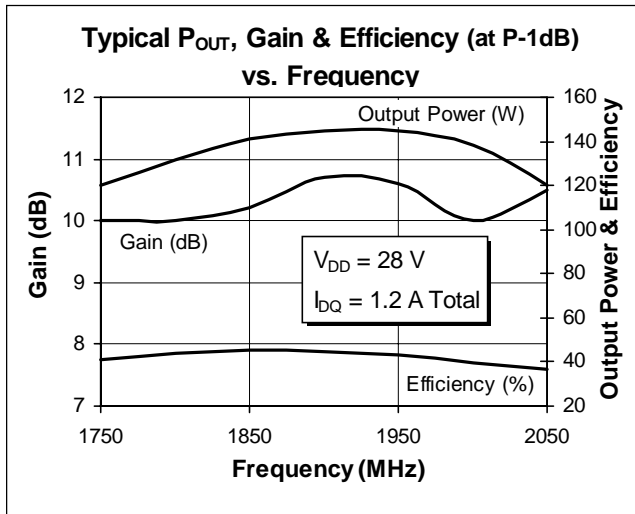

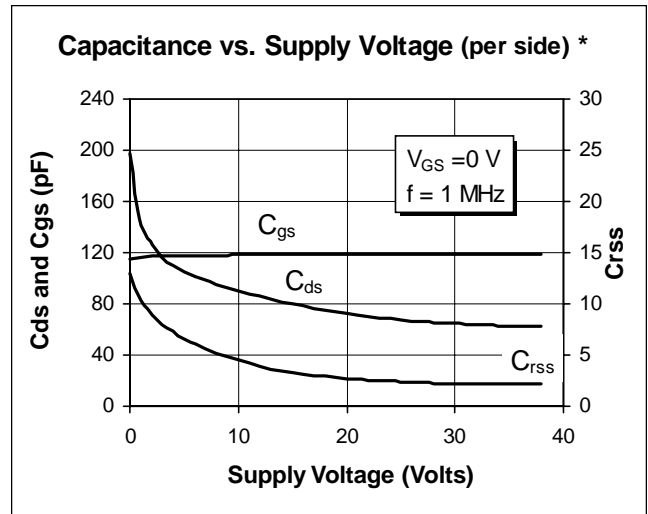
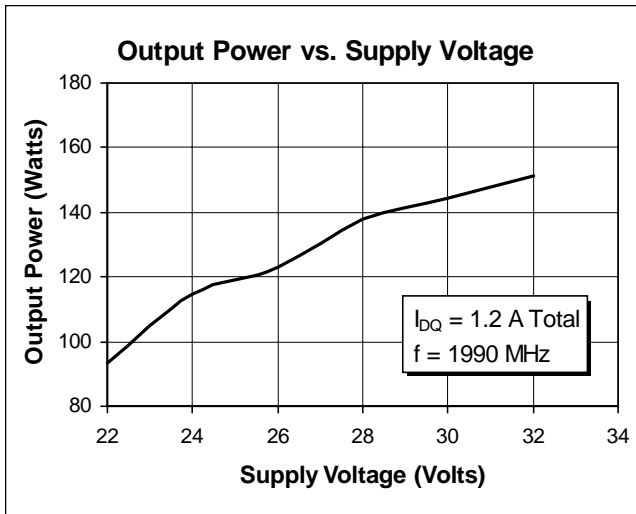
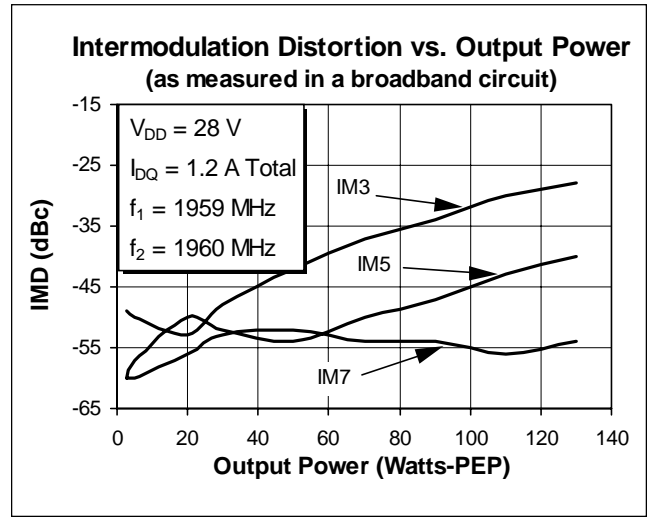
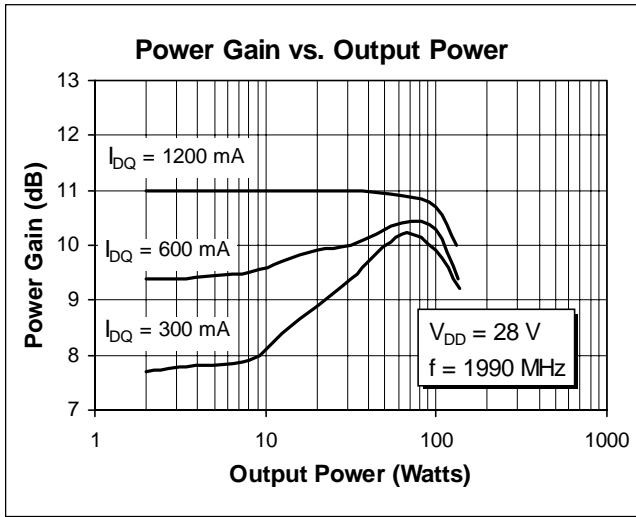

Impedance Data

($V_{DD} = 28\text{ V}$, $P_{OUT} = 120\text{ W}$,
 $I_{DQ} = 1.2\text{ A Total}$)

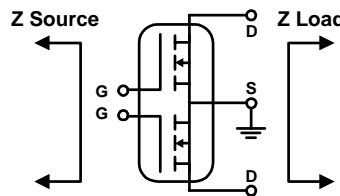

Frequency	Z Source Ω		Z Load Ω	
	R	jX	R	jX
1.75	7.6	-10.5	4.6	-3.6
1.80	8.8	-13.0	4.2	-3.2
1.85	9.8	-14.1	4.0	-2.8
1.90	11.0	-15.2	3.7	-2.8
1.95	12.0	-17.0	3.6	-3.2
2.00	13.4	-17.5	3.4	-3.8
2.05	14.6	-18.0	3.2	-4.4

* This part is internally matched. Measurements of the finished product will not yield these results.

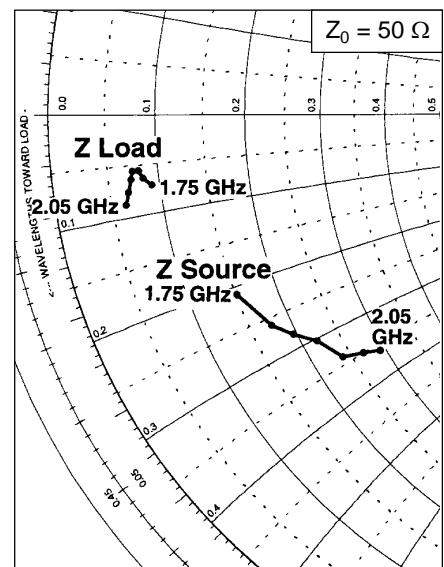

Test Circuit

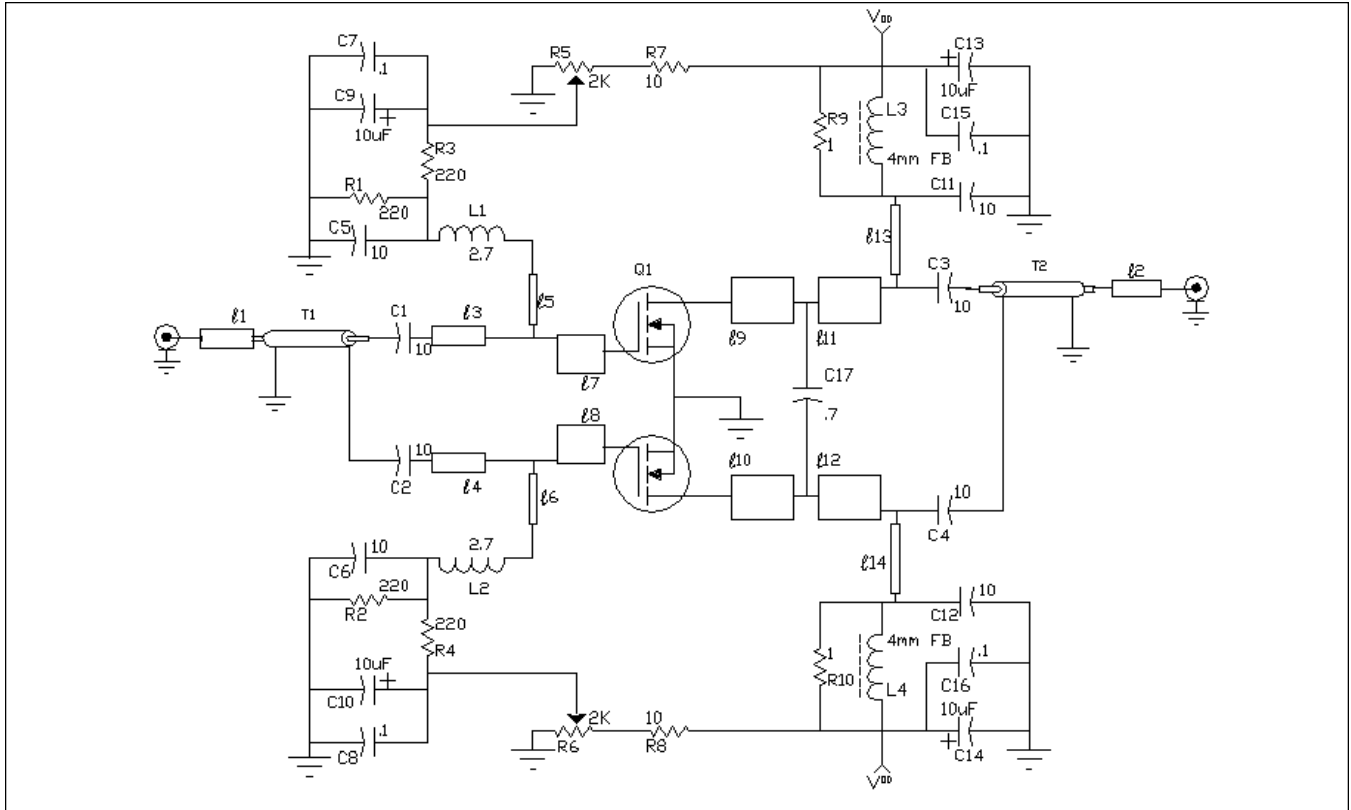

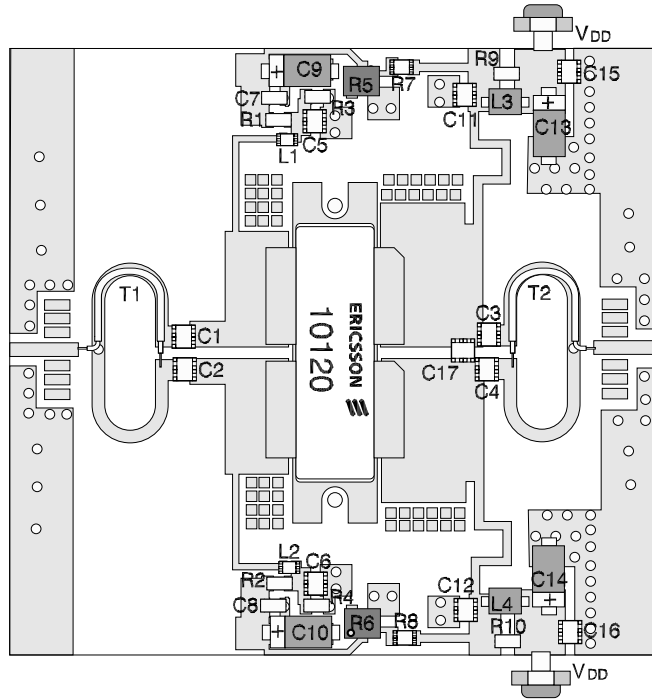

Test Circuit Block Diagram for $f = 2.0$ GHz

Q1	PTF 10120	LDMOS RF Transistor	L1, L2	2.7 nh	SMT Coil
$l1, l2$		Microstrip 50 Ω	L3, L4	4 mm	SMT Ferrite Bead
$l3, l4$.048 λ @ 2.0 GHz	Microstrip 31.7 Ω	R1, R2, R3, R4	220 Ω	Chip Resistor K1206
$l5, l6$.18 λ @ 2.0 GHz	Microstrip 70 Ω	R5, R6	2K	SMT Potentiometer
$l7, l8$.097 λ @ 2.0 GHz	Microstrip 9.35 Ω	R7, R8	10 Ω	Chip Resistor K1206
$l9, l10$.129 λ @ 2 GHz	Microstrip 7.6 Ω	R9, R10	1 Ω	Chip Resistor K1206
$l11, l12$.031 λ @ 2 GHz	Microstrip 8.8 Ω	T1, T2	50 Ω Coaxial Balun	
$l13, l14$.25 λ @ 2 GHz	Microstrip 65 Ω	Circuit Board	.028" Dielectric Thickness, $\epsilon_r = 4.0$, AlliedSignal, G200, 2 oz. copper	
C1, C2, C3, C4, C5, C6, C11, C12	10 pF Chip Cap	ATC 100 B			
C7, C8, C15, C16	0.1 μ F Chip Cap	K1206			
C9, C10, C13, C14	10 μ F SMT Tantalum Cap				
C17	0.7 pF Chip Cap	ATC 100 B			

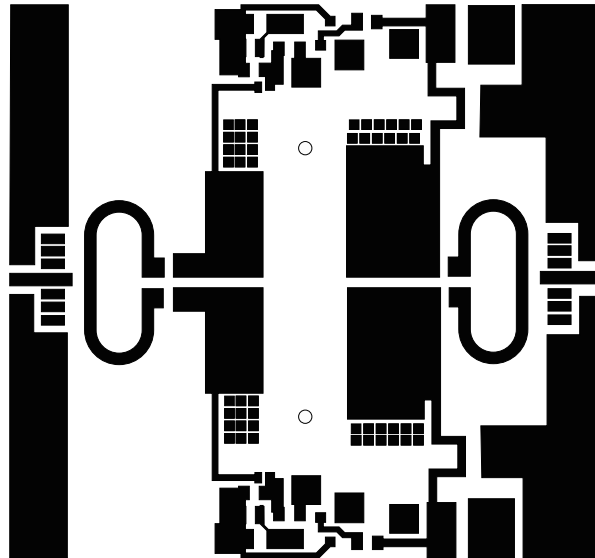

Parts Layout (not to scale)



Artwork (1 inch  *)*

Notes: