

256MB 32-bit Direct Rambus DRAM RIMM™ Module**MC-4R256FKK6K (64M words × 16 bits × 2 channels)**

Description

The 32-bit Direct Rambus RIMM module is a general-purpose high-performance lines of memory modules suitable for use in a broad range of applications including computer memory, personal computers, workstations, and other applications where high bandwidth and latency are required.

The 32-bit RIMM module consists of 288Mb Direct Rambus DRAM (Direct RDRAM) devices. These are extremely high-speed CMOS DRAMs organized as 16M words by 18 bits. The use of Rambus Signaling Level (RSL) technology permits the use of conventional system and board design technologies. The 32-bit RIMM modules support 800MHz transfer rate per pin, resulting in total module bandwidth of 3.2GB/s.

The 32-bit RIMM module provides two independent 16 bit memory channels to facilitate compact system design. The "Thru" Channel enters and exits the module to support a connection to or from a controller, memory slot, or termination. The "Term" Channel is terminated on the module and supports a connection from a controller or another memory slot.

The RDRAM® architecture enables the highest sustained bandwidth for multiple, simultaneous, randomly addressed memory transactions. The separate control and data buses with independent row and column control yield over 95% bus efficiency. The RDRAM device multi-bank architecture supports up to four simultaneous transactions per device.

Features

- 256MB Direct RDRAM storage and 256 banks total on module
- 2 independent Direct RDRAM channels, 1 pass through and 1 terminated on 32-bit RIMM module
- High speed 800MHz Direct RDRAM devices
- 232 edge connector pads with 1mm pad spacing
 - Module PCB size: 133.35mm × 39.925mm × 1.27mm
 - Gold plated edge connector pads contacts
- Serial Presence Detect (SPD) support
- Operates from a 2.5V (±5%) supply
- Low power and power down self refresh modes
- Separate Row and Column buses for higher efficiency

Ordering Information

Part number	Organization	I/O Freq. (MHz)	RAS access time (ns)	Package	Mounted devices
MC-4R256FKK6K-840	64M x 16 x 2	800	40	232 edge connector pads RIMM with heat spreader Edge connector: Gold plated	8 pieces of μ PD488588FF FBGA (μ BGA [®]) package

Module Pad Names

Pad	Signal name	Pad	Signal name	Pad	Signal name	Pad	Signal name
A1	GND	B1	GND	A59	GND	B59	GND
A2	SCK_THRU_L	B2	CMD_THRU_L	A60	VTERM	B60	VTERM
A3	GND	B3	GND	A61	VTERM	B61	VTERM
A4	DQA8_THRU_L	B4	DQA7_THRU_L	A62	GND	B62	GND
A5	GND	B5	GND	A63	DQA3_THRU_R	B63	DQA4_THRU_R
A6	DQA6_THRU_L	B6	DQA5_THRU_L	A64	GND	B64	GND
A7	GND	B7	GND	A65	DQA5_THRU_R	B65	DQA6_THRU_R
A8	DQA4_THRU_L	B8	DQA3_THRU_L	A66	GND	B66	GND
A9	GND	B9	GND	A67	DQA7_THRU_R	B67	DQA8_THRU_R
A10	DQA2_THRU_L	B10	DQA1_THRU_L	A68	GND	B68	GND
A11	GND	B11	GND	A69	VDD	B69	VDD
A12	DQA0_THRU_L	B12	CTMN_THRU_L	A70	GND	B70	GND
A13	GND	B13	GND	A71	SCK_THRU_R	B71	CTMN_TERM_L
A14	CFM_THRU_L	B14	CTM_THRU_L	A72	GND	B72	GND
A15	GND	B15	GND	A73	CMD_THRU_R	B73	CTM_TERM_L
A16	CFMN_THRU_L	B16	ROW2_THRU_L	A74	GND	B74	GND
A17	GND	B17	GND	A75	VREF	B75	VCMOS
A18	ROW1_THRU_L	B18	ROW0_THRU_L	A76	VDD	B76	VDD
A19	GND	B19	GND	A77	SVDD	B77	SWP
A20	COL4_THRU_L	B20	COL3_THRU_L	A78	VDD	B78	VDD
A21	GND	B21	GND	A79	SCL	B79	SDA
A22	COL2_THRU_L	B22	COL1_THRU_L	A80	VDD	B80	VDD
A23	GND	B23	GND	A81	SA0	B81	SA1
A24	COL0_THRU_L	B24	DQB0_THRU_L	A82	VDD	B82	VDD
A25	GND	B25	GND	A83	SA2	B83	SIN_TERM
A26	DQB1_THRU_L	B26	DQB2_THRU_L	A84	GND	B84	GND
A27	GND	B27	GND	A85	DQB8_TERM	B85	DQB7_TERM
A28	DQB3_THRU_L	B28	DQB4_THRU_L	A86	GND	B86	GND
A29	GND	B29	GND	A87	DQB6_TERM	B87	DQB5_TERM
A30	DQB5_THRU_L	B30	DQB6_THRU_L	A88	GND	B88	GND
A31	GND	B31	GND	A89	DQB4_TERM	B89	DQB3_TERM
A32	DQB7_THRU_L	B32	DQB8_THRU_L	A90	GND	B90	GND
A33	GND	B33	GND	A91	DQB2_TERM	B91	DQB1_TERM
A34	SOUT_THRU	B34	SIN_THRU	A92	GND	B92	GND
A35	GND	B35	GND	A93	DQB0_TERM	B93	COL0_TERM
A36	DQB8_THRU_R	B36	DQB7_THRU_R	A94	GND	B94	GND

Pad	Signal name	Pad	Signal name
A37	GND	B37	GND
A38	DQB6_THRU_R	B38	DQB5_THRU_R
A39	GND	B39	GND
A40	DQB4_THRU_R	B40	DQB3_THRU_R
A41	GND	B41	GND
A42	DQB2_THRU_R	B42	DQB1_THRU_R
A43	GND	B43	GND
A44	DQB0_THRU_R	B44	COL0_THRU_R
A45	GND	B45	GND
A46	COL1_THRU_R	B46	COL2_THRU_R
A47	GND	B47	GND
A48	COL3_THRU_R	B48	COL4_THRU_R
A49	GND	B49	GND
A50	ROW0_THRU_R	B50	ROW1_THRU_R
A51	GND	B51	GND
A52	ROW2_THRU_R	B52	CFMN_THRU_R
A53	GND	B53	GND
A54	CTM_THRU_R	B54	CFM_THRU_R
A55	GND	B55	GND
A56	CTMN_THRU_R	B56	DQA0_THRU_R
A57	GND	B57	GND
A58	DQA1_THRU_R	B58	DQA2_THRU_R

Pad	Signal name	Pad	Signal name
A95	COL1_TERM	B95	COL2_TERM
A96	GND	B96	GND
A97	COL3_TERM	B97	COL4_TERM
A98	GND	B98	GND
A99	ROW0_TERM	B99	ROW1_TERM
A100	GND	B100	GND
A101	ROW2_TERM	B101	CFMN_TERM
A102	GND	B102	GND
A103	CTM_TERM_R	B103	CFM_TERM
A104	GND	B104	GND
A105	CTMN_TERM_R	B105	DQA0_TERM
A106	GND	B106	GND
A107	DQA1_TERM	B107	DQA2_TERM
A108	GND	B108	GND
A109	DQA3_TERM	B109	DQA4_TERM
A110	GND	B110	GND
A111	DQA5_TERM	B111	DQA6_TERM
A112	GND	B112	GND
A113	DQA7_TERM	B113	DQA8_TERM
A114	GND	B114	GND
A115	CMD_TERM	B115	SCK_TERM
A116	GND	B116	GND

Module Connector Pad Description

Signal	Module connector pads	I/O	Type	Description
CFM_THRU_L	A14	I	RSL	Clock From Master. Connects to left RDRAM device on "Thru" Channel. Interface clock used for receiving RSL signals from the controller. Positive polarity.
CFM_THRU_R	B54	I	RSL	Clock From Master. Connects to right RDRAM device on "Thru" Channel. Interface clock used for receiving RSL signals from the controller. Positive polarity.
CFMN_THRU_L	A16	I	RSL	Clock From Master. Connects to left RDRAM device on "Thru" Channel. Interface clock used for receiving RSL signals from the controller. Negative polarity.
CFMN_THRU_R	B52	I	RSL	Clock From Master. Connects to right RDRAM device on "Thru" Channel. Interface clock used for receiving RSL signals from the controller. Negative polarity.
CMD_THRU_L	B2	I	VC MOS	Serial Command Input used to read from and write to the control registers. Also used for power management. Connects to left RDRAM device on "Thru" Channel.
CMD_THRU_R	A73	I	VC MOS	Serial Command Input used to read from and write to the control registers. Also used for power management. Connects to right RDRAM device on "Thru" Channel.
COL4_THRU_L.. COL0_THRU_L	A20, B20, A22, B22, A24	I	RSL	"Thru" Channel Column bus. 5-bit bus containing control and address information for column accesses. Connects to left RDRAM device on "Thru" Channel.
COL4_THRU_R.. COL0_THRU_R	B48, A48, B46, A46, B44	I	RSL	"Thru" Channel Column bus. 5-bit bus containing control and address information for column accesses. Connects to right RDRAM device on "Thru" Channel.
CTM_THRU_L	B14	I	RSL	Clock To Master. Connects to left RDRAM device on "Thru" Channel. Interface clock used for transmitting RSL signals to the controller. Positive polarity.
CTM_THRU_R	A54	I	RSL	Clock To Master. Connects to right RDRAM device on "Thru" Channel. Interface clock used for transmitting RSL signals to the controller. Positive polarity.
CTMN_THRU_L	B12	I	RSL	Clock To Master. Connects to left RDRAM device on "Thru" Channel. Interface clock used for transmitting RSL signals to the controller. Negative polarity.
CTMN_THRU_R	A56	I	RSL	Clock To Master. Connects to right RDRAM device on "Thru" Channel. Interface clock used for transmitting RSL signals to the controller. Negative polarity.
DQA8_THRU_L.. DQA0_THRU_L	A4, B4, A6, B6, A8, B8, A10, B10, A12	I/O	RSL	"Thru" Channel Data bus A. A 9-bit bus carrying a byte of read or write data between the controller and RDRAM devices on "Thru" Channel. Connects to left RDRAM device on "Thru" Channel. DQA8_THRU_L is non-functional on modules.
DQA8_THRU_R.. DQA0_THRU_R	B67, A67, B65, A65, B63, A63, B58, A58, B56	I/O	RSL	"Thru" Channel Data bus A. A 9-bit bus carrying a byte of read or write data between the controller and RDRAM devices on "Thru" Channel. Connects to right RDRAM device on "Thru" Channel. DQA8_THRU_R is non-functional on modules.
DQB8_THRU_L.. DQB0_THRU_L	B32, A32, B30, A30, B28, A28, B26, A26, B24	I/O	RSL	"Thru" Channel Data bus B. A 9-bit bus carrying a byte of read or write data between the controller and RDRAM devices on "Thru" Channel. Connects to left RDRAM device on "Thru" Channel. DQB8_THRU_L is non-functional on modules.
DQB8_THRU_R.. DQB0_THRU_R	A36, B36, A38, B38, A40, B40, A42, B42, A44	I/O	RSL	"Thru" Channel Data bus B. A 9-bit bus carrying a byte of read or write data between the controller and RDRAM devices on "Thru" Channel. Connects to right RDRAM device on "Thru" Channel. DQB8_THRU_R is non-functional on modules.
ROW2_THRU_L.. ROW0_THRU_L	B16, A18, B18	I	RSL	Row bus. 3-bit bus containing control and address information for row accesses. Connects to left RDRAM device on "Thru" Channel.

Signal	Module connector pads	I/O	Type	Description
ROW2_THRU_R.. ROW0_THRU_R	A52, B50, A50	I	RSL	Row bus. 3-bit bus containing control and address information for row accesses. Connects to right RDRAM device on "Thru" Channel.
SCK_THRU_L	A2	I	VCMOS	Serial Clock input. Clock source used to read from and write to "Thru" Channel RDRAM control registers. Connects to left RDRAM device on "Thru" Channel.
SCK_THRU_R	A71	I	VCMOS	Serial Clock input. Clock source used to read from and write to "Thru" Channel RDRAM control registers. Connects to right RDRAM device on "Thru" Channel.
SIN_THRU	B34	I/O	VCMOS	"Thru" Channel Serial I/O for reading from and writing to the control registers. Attaches to SIO0 of right RDRAM device on "Thru" Channel.
SOUT_THRU	A34	I/O	VCMOS	"Thru" Channel Serial I/O for reading from and writing to the control registers. Attaches to SIO1 of left RDRAM device on "Thru" Channel.
CFM_TERM	B103	I	RSL	Clock from master. Connects to right RDRAM device on "Term" Channel. Interface clock used for receiving RSL signals from the controller. Positive polarity.
CFMN_TERM	B101	I	RSL	Clock from master. Connects to right RDRAM device on "Term" Channel. Interface clock used for receiving RSL signals from the controller. Negative polarity.
CMD_TERM	A115	I	VCMOS	Serial Command Input used to read from and write to the control registers. Also used for power management. Connects to right RDRAM device on "Term" Channel.
COL4_TERM.. COL0_TERM	B97, A97, B95, A95, B93	I	RSL	"Term" Channel Column bus. 5-bit bus containing control and address information for column accesses. Connects to right RDRAM device on "Term" Channel.
CTM_TERM_L	B73	I	RSL	Clock To Master. Connects to left RDRAM device on "Term" Channel. Interface clock used for transmitting RSL signals to the controller. Positive polarity.
CTM_TERM_R	A103	I	RSL	Clock To Master. Connects to right RDRAM device on "Term" Channel. Interface clock used for transmitting RSL signals to the controller. Positive polarity.
CTMN_TERM_L	B71	I	RSL	Clock To Master. Connects to left RDRAM device on "Term" Channel. Interface clock used for transmitting RSL signals to the controller. Negative polarity.
CTMN_TERM_R	A105	I	RSL	Clock To Master. Connects to right RDRAM device on "Term" Channel. Interface clock used for transmitting RSL signals to the controller. Negative polarity.
DQA8_TERM.. DQA0_TERM	B113, A113, B111, A111, B109, A109, B107, A107, B105	I/O	RSL	"Term" Channel Data bus A. A 9-bit bus carrying a byte of read or write data between the controller and RDRAM devices on "Term" Channel. Connects to right RDRAM device on "Term" Channel. DQA8_TERM is non-functional on modules.
DQB8_TERM.. DQB0_TERM	A85, B85, A87, B87, A89, B89, A91, B91, A93	I/O	RSL	"Term" Channel Data bus B. A 9-bit bus carrying a byte of read or write data between the controller and RDRAM devices on "Term" Channel. Connects to right RDRAM device on "Term" Channel. DQB8_TERM is non-functional on modules.
ROW2_TERM.. ROW0_TERM	A101, B99, A99	I	RSL	"Term" Channel Row bus. 3-bit bus containing control and address information for row accesses. Connects to right RDRAM device on "Term" Channel.
SCK_TERM	B115	I	VCMOS	Serial Clock input. Clock source used to read from and write to "Term" Channel RDRAM control registers. Connects to right RDRAM device on "Term" Channel.
SIN_TERM	B83	I/O	VCMOS	"Term" Channel Serial I/O for reading from and writing to the control registers. Attaches to SIO0 of left RDRAM device on "Term" Channel.
VTERM	A60, B60, A61, B61			"Term" Channel Termination voltage.

Signal	Module connector pads	I/O	Type	Description
GND	A1, A3, A5, A7, A9, A11, A13, A15, A17, A19, A21, A23, A25, A27, A29, A31, A33, A35, A37, A39, A41, A43, A45, A47, A49, A51, A53, A55, A57, A59, A62, A64, A66, A68, A70, A72, A74, A84, A86, A88, A90, A92, A94, A96, A98, A100, A102, A104, A106, A108, A110, A112, A114, A116, B1, B3, B5, B7, B9, B11, B13, B15, B17, B19, B21, B23, B25, B27, B29, B31, B33, B35, B37, B39, B41, B43, B45, B47, B49, B51, B53, B55, B57, B59, B62, B64, B66, B68, B70, B72, B74, B84, B86, B88, B90, B92, B94, B96, B98, B100, B102, B104, B106, B108, B110, B112, B114, B116			Ground reference for RDRAM core and interface.
SA0	A81	I	SVDD	Serial Presence Detect Address 0
SA1	B81	I	SVDD	Serial Presence Detect Address 1.
SA2	A83	I	SVDD	Serial Presence Detect Address 2.
SCL	A79	I	SVDD	Serial Presence Detect Clock.
SDA	B79	I/O	SVDD	Serial Presence Detect Data (Open Collector I/O).
SVDD	A77			SPD Voltage. Used for signals SCL, SDA, SWE, SA0, SA1 and SA2.
SWP	B77	I	SVDD	Serial Presence Detect Write Protect (active high). When low, the SPD can be written as well as read.
VCMOS	B75			CMOS I/O Voltage. Used for signals CMD, SCK, SIN, SOUT.
VDD	A69, B69, A76, B76, A78, B78, A80, B80, A82, B82			Supply voltage for the RDRAM core and interface logic.
VREF	A75			Logic threshold reference voltage for both "Thru" Channel and "Term" Channel RSL signals.

Block Diagram

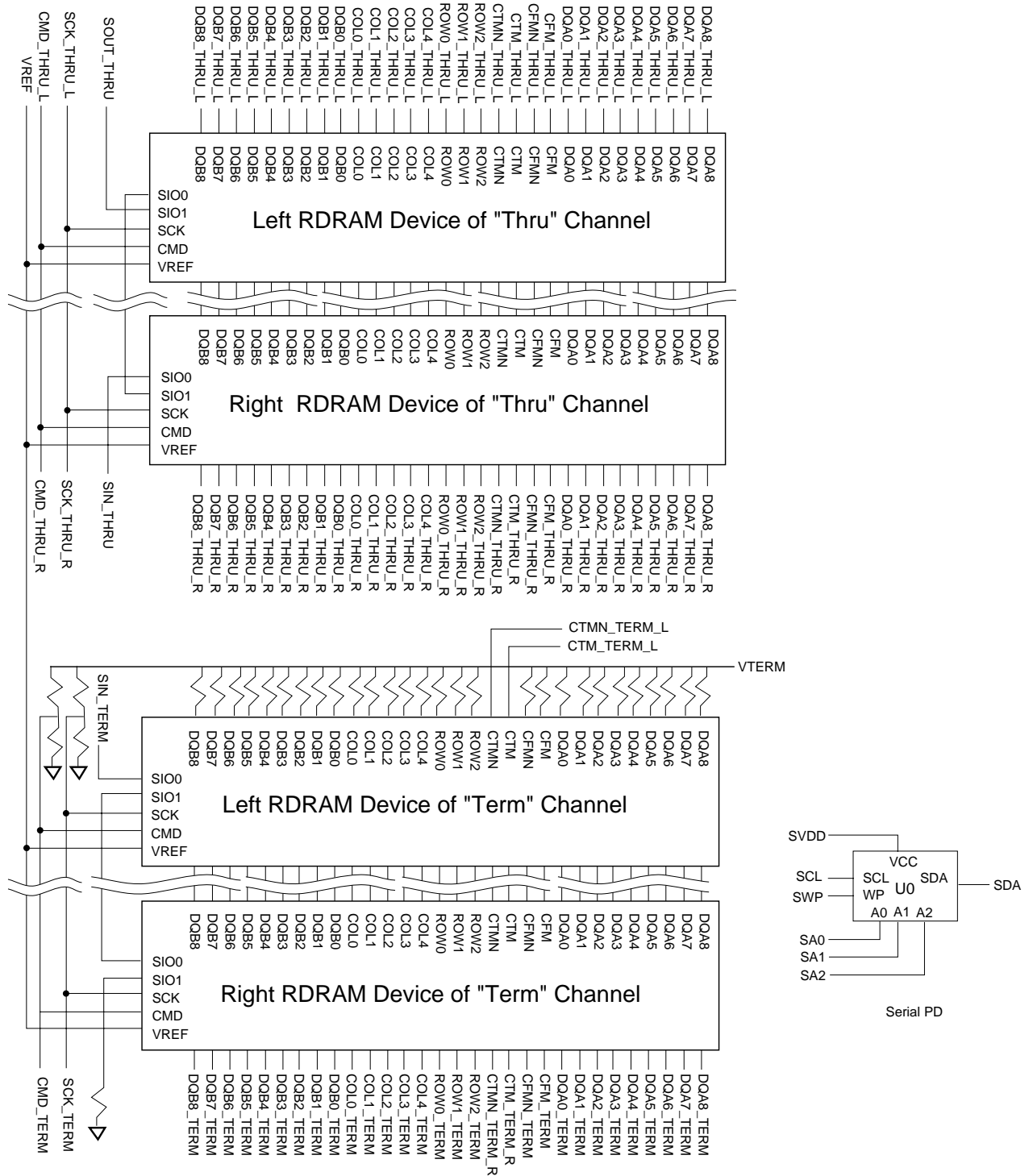

Electrical Specifications

Absolute Maximum Ratings

Symbol	Parameter	MIN.	MAX.	Unit
VI,ABS	Voltage applied to any RSL or CMOS signal pad with respect to GND	-0.3	VDD + 0.3	V
VDD,ABS	Voltage on VDD with respect to GND	-0.5	VDD + 1.0	V
TSTORE	Storage temperature	-50	+100	°C

Caution

Exposing the device to stress above those listed in Absolute Maximum Ratings could cause permanent damage. The device is not meant to be operated under conditions outside the limits described in the operational section of this specification. Exposure to Absolute Maximum Rating conditions for extended periods may affect device reliability.

DC Recommended Electrical Conditions

Symbol	Parameter and conditions	MIN.	MAX.	Unit
VDD	Supply voltage ^{Note}	2.50 – 0.13	2.50 + 0.13	V
VCMOS	CMOS I/O power supply at pad 2.5V controllers	VDD	VDD	V
	1.8V controllers	1.8 – 0.1	1.8 + 0.2	
VREF	Reference voltage ^{Note}	1.4 – 0.2	1.4 + 0.2	V
SVDD	Serial Presence Detector- positive power supply	2.2	3.6	V
VTERM	Termination Voltage	1.89 – 0.09	1.89 + 0.09	V

Note: See Direct RDRAM datasheet for more details.

AC Electrical Specifications

Symbol	Parameter and Conditions ^{Note1}	MIN.	TYP.	MAX.	Unit
ZL	Module Impedance of RSL signals	25.2	28.0	30.8	Ω
ZUL-CMOS	Module Impedance of SCK and CMD signals	23.8	28.0	32.2	Ω
TPD	Average clock delay from finger to finger of all RSL clock nets (CTM, CTMN,CFM, and CFMN) ^{Note2}			1.02	ns
ΔTPD	Propagation delay variation of RSL signals with respect to TPD ^{Note1, 3}	-21		+21	ps
ΔTPD-CMOS	Propagation delay variation of SCK signal with respect to an average clock delay ^{Note1}	-250		+250	ps
ΔTPD- SCK,CMD	Propagation delay variation of CMD signal with respect to SCK signal	-200		+200	ps
Vα/VIN	Attenuation Limit			16.0	%
VXF/VIN	Forward crosstalk coefficient (300ps input rise time 20% - 80%)			4.0	%
VXB/VIN	Backward crosstalk coefficient (300ps input rise time 20% - 80%)			2.0	%
RDC	DC Resistance Limit			0.8	Ω

Notes 1. Specifications apply per channel.

2. TPD or Average clock delay is defined as the average delay from finger to finger of all RSL clock nets (CTM, CTMN, CFM, and CFMN).

3. If the RIMM module meets the following specification, then it is compliant to the specification. If the RIMM module does not meet these specifications, then the specification can be adjusted by the "Adjusted ΔTPD Specification" table.

Adjusted ΔTPD Specification

Symbol	Parameter and conditions	Adjusted MIN./MAX.	Absolute		Unit
			MIN.	MAX.	
ΔTPD	Propagation delay variation of RSL signals with respect to TPD	+/- [17+(18*N*ΔZ0)] ^{Note}	-30	30	ps

Note N = Number of RDRAM devices installed on the RIMM module.

$$\Delta Z0 = \text{delta } Z0\% = (\text{MAX. } Z0 - \text{MIN. } Z0) / (\text{MIN. } Z0)$$

(MAX. Z0 and MIN. Z0 are obtained from the loaded (high impedance) impedance coupons of all RSL layers on the module.)

RIMM Module Current Profile

IDD	RIMM module power conditions ^{Note1}	MAX.	Unit
IDD1	One RDRAM device per channel in Read ^{Note2} , balance in NAP mode	1435	mA
IDD2	One RDRAM device per channel in Read ^{Note2} , balance in Standby mode	1950	mA
IDD3	One RDRAM device per channel in Read ^{Note2} , balance in Active mode	2220	mA
IDD4	One RDRAM device per channel in Write, balance in NAP mode	1555	mA
IDD5	One RDRAM device per channel in Write, balance in Standby mode	2070	mA
IDD6	One RDRAM device per channel in Write, balance in Active mode	2340	mA

- Notes 1. Actual power will depend on individual RDRAM component specifications, memory controller and usage patterns. Please refer to specific RIMM module vendor data sheets for additional information. Power does not include Refresh Current. Max current computed for x16 256Mb RDRAM components. x18 288Mb RDRAM components use 8 mA more current per RDRAM device in Read and 60mA more current per RDRAM device in Write.
2. I/O current is a function of the % of 1's, to add I/O power for 50 % 1's for a x16 need to add 257mA for the following : VDD = 2.5V, VTERM = 1.8V, VREF = 1.4V and VDIL = VREF – 0.5V.

Physical Outline

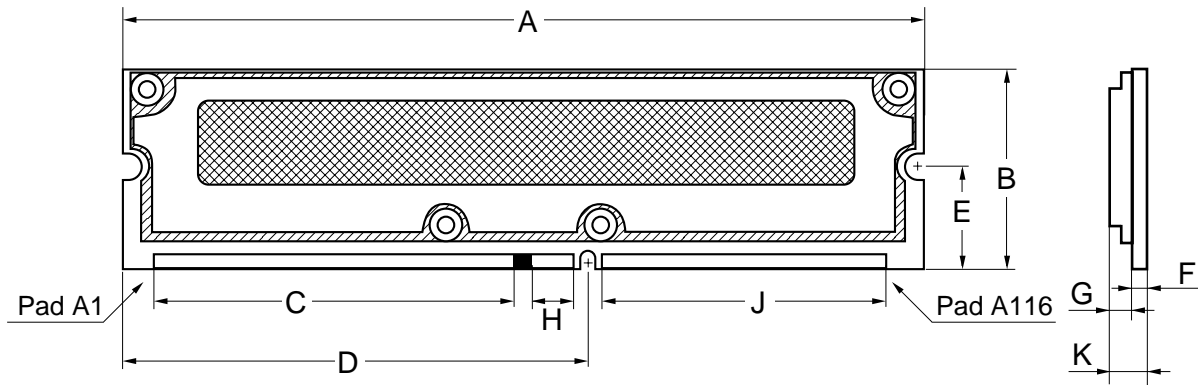

Item	Description	min.	typ.	max.	Unit
A	PCB length	133.22	133.35	133.48	mm
B	PCB height	34.795	34.925	35.055	mm
C	Center-center pad width from pad A1 to A60, B1 to B60	-	59.00	-	mm
D	Spacing from PCB left edge to connector key notch	-	78.170	-	mm
E	Spacing from contact pad PCB edge to side edge retainer notch	-	17.78	-	mm
F	PCB thickness	1.17	1.27	1.37	mm
G	Heat spreader thickness from PCB surface (one side) to heat spreader top surface	-	-	3.09	mm
H	Center-center pad width from pad A61 to A68, B61 to B68	-	7.00	-	mm
J	Center-center pad width from pad A69 to A116, B69 to B116	-	47.00	-	mm
K	RIMM thickness	-	-	4.46	mm

ECA-TS2-0065-01

CAUTION FOR HANDLING MEMORY MODULES

When handling or inserting memory modules, be sure not to touch any components on the modules, such as the memory ICs, chip capacitors and chip resistors. It is necessary to avoid undue mechanical stress on these components to prevent damaging them.

In particular, do not push module cover or drop the modules in order to protect from mechanical defects, which would be electrical defects.

When re-packing memory modules, be sure the modules are not touching each other.

Modules in contact with other modules may cause excessive mechanical stress, which may damage the modules.

MDE0202

NOTES FOR CMOS DEVICES**① PRECAUTION AGAINST ESD FOR MOS DEVICES**

Exposing the MOS devices to a strong electric field can cause destruction of the gate oxide and ultimately degrade the MOS devices operation. Steps must be taken to stop generation of static electricity as much as possible, and quickly dissipate it, when once it has occurred. Environmental control must be adequate. When it is dry, humidifier should be used. It is recommended to avoid using insulators that easily build static electricity. MOS devices must be stored and transported in an anti-static container, static shielding bag or conductive material. All test and measurement tools including work bench and floor should be grounded. The operator should be grounded using wrist strap. MOS devices must not be touched with bare hands. Similar precautions need to be taken for PW boards with semiconductor MOS devices on it.

② HANDLING OF UNUSED INPUT PINS FOR CMOS DEVICES

No connection for CMOS devices input pins can be a cause of malfunction. If no connection is provided to the input pins, it is possible that an internal input level may be generated due to noise, etc., hence causing malfunction. CMOS devices behave differently than Bipolar or NMOS devices. Input levels of CMOS devices must be fixed high or low by using a pull-up or pull-down circuitry. Each unused pin should be connected to V_{DD} or GND with a resistor, if it is considered to have a possibility of being an output pin. The unused pins must be handled in accordance with the related specifications.

③ STATUS BEFORE INITIALIZATION OF MOS DEVICES

Power-on does not necessarily define initial status of MOS devices. Production process of MOS does not define the initial operation status of the device. Immediately after the power source is turned ON, the MOS devices with reset function have not yet been initialized. Hence, power-on does not guarantee output pin levels, I/O settings or contents of registers. MOS devices are not initialized until the reset signal is received. Reset operation must be executed immediately after power-on for MOS devices having reset function.

CME0107

Rambus, RDRAM and the Rambus logo are registered trademarks of Rambus Inc.

RIMM, SO-RIMM, RaSer and QRSL are trademarks of Rambus Inc.

μBGA is a registered trademark of Tessera, Inc.

The information in this document is subject to change without notice. Before using this document, confirm that this is the latest version.

No part of this document may be copied or reproduced in any form or by any means without the prior written consent of Elpida Memory, Inc.

Elpida Memory, Inc. does not assume any liability for infringement of any intellectual property rights (including but not limited to patents, copyrights, and circuit layout licenses) of Elpida Memory, Inc. or third parties by or arising from the use of the products or information listed in this document. No license, express, implied or otherwise, is granted under any patents, copyrights or other intellectual property rights of Elpida Memory, Inc. or others.

Descriptions of circuits, software and other related information in this document are provided for illustrative purposes in semiconductor product operation and application examples. The incorporation of these circuits, software and information in the design of the customer's equipment shall be done under the full responsibility of the customer. Elpida Memory, Inc. assumes no responsibility for any losses incurred by customers or third parties arising from the use of these circuits, software and information.

[Product applications]

Elpida Memory, Inc. makes every attempt to ensure that its products are of high quality and reliability. However, users are instructed to contact Elpida Memory's sales office before using the product in aerospace, aeronautics, nuclear power, combustion control, transportation, traffic, safety equipment, medical equipment for life support, or other such application in which especially high quality and reliability is demanded or where its failure or malfunction may directly threaten human life or cause risk of bodily injury.

[Product usage]

Design your application so that the product is used within the ranges and conditions guaranteed by Elpida Memory, Inc., including the maximum ratings, operating supply voltage range, heat radiation characteristics, installation conditions and other related characteristics. Elpida Memory, Inc. bears no responsibility for failure or damage when the product is used beyond the guaranteed ranges and conditions. Even within the guaranteed ranges and conditions, consider normally foreseeable failure rates or failure modes in semiconductor devices and employ systemic measures such as fail-safes, so that the equipment incorporating Elpida Memory, Inc. products does not cause bodily injury, fire or other consequential damage due to the operation of the Elpida Memory, Inc. product.

[Usage environment]

This product is not designed to be resistant to electromagnetic waves or radiation. This product must be used in a non-condensing environment.

If you export the products or technology described in this document that are controlled by the Foreign Exchange and Foreign Trade Law of Japan, you must follow the necessary procedures in accordance with the relevant laws and regulations of Japan. Also, if you export products/technology controlled by U.S. export control regulations, or another country's export control laws or regulations, you must follow the necessary procedures in accordance with such laws or regulations.

If these products/technology are sold, leased, or transferred to a third party, or a third party is granted license to use these products, that third party must be made aware that they are responsible for compliance with the relevant laws and regulations.

M01E0107