



Description

The ELM382 is a digitally configurable, multi-stage counter circuit in a single 8 pin package. When connected to a 50Hz source, four time periods from one hour to one week are possible, as shown in Table 1 below.

Although the circuit has been optimized for a 50Hz input frequency, it is capable of being operated over a very wide range of frequencies. Of particular interest is the ability to interface directly to very low frequencies with varying waveforms due to the use of a Schmitt trigger input circuitry.

The ELM382 provides two outputs – a standard 50% duty cycle divider output, and a momentarily pulsed output. The pulse output is useful for audibly or visually signalling the beginning of a time period, or as a trigger for other circuitry. Refer to the Example Applications section for two typical circuits.

Features

- Low power CMOS design - typically 1mA at 5V
- Wide supply range – 3.0 to 5.5 volt operation
- Digitally selectable delays
- Schmitt trigger circuitry on the clock input
- Completely static operation
- Long term accuracy with line frequency clock
- High current drive outputs – up to 25 mA
- Reset input provided with a pullup resistor

Applications

- Long term (daily or weekly) event timers
- Missing event detectors
- Automatic shutoff circuits

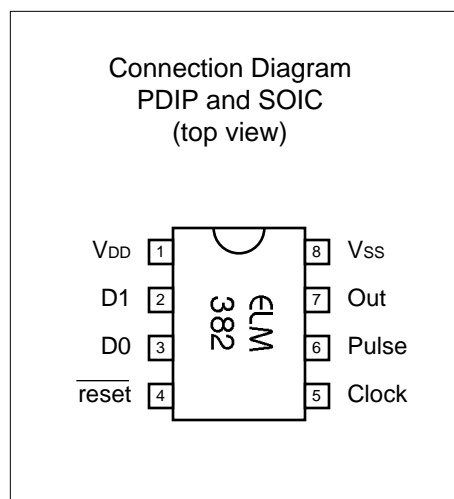

Block Diagram

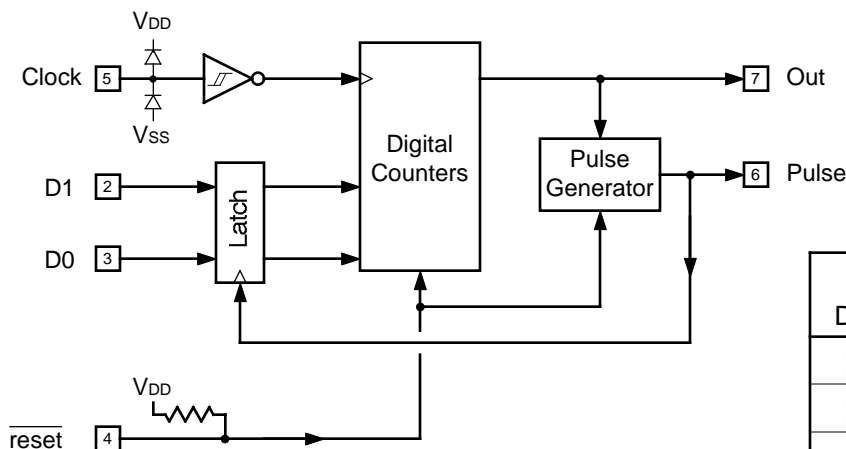

Setting		Divisor	Period
D1	D0	x 1000	(50Hz)
L	L	180	1 hour
L	H	2160	12 hrs
H	L	4320	24 hrs
H	H	30,240	7 days

Table 1



Pin Descriptions

VDD (pin 1)

This pin is the positive supply pin, and should always be the most positive point in the circuit. Internal circuitry connected to this pin is used to provide power on reset of the microprocessor, so an external reset signal is normally not required. Refer to the Electrical Characteristics section for further information.

D1 (pin 2) and D0 (pin 3)

The logic levels on these pins control the divider ratio, as shown in Table 1. Their levels are stored in an internal latch on the low to high transition of the Pulse output, and are used for that entire timing period.

reset (pin 4)

An active low input that forces both outputs low, and causes all counter stages to initialize. If unused, it can be left open circuited (due to the internal resistor) or preferably tied to VDD. Refer to the minimum timing requirements in the Electrical Characteristics section.

Clock (pin 5)

The counter stages advance on the falling edge (VDD to VSS) of this input, if there is no reset signal

present. The Schmitt trigger amplifier on the input simplifies the coupling to slowly varying signals, while the inherent protection diodes (shown in the block diagram) allow signals with peak levels beyond the supply limits to be connected through a current limiting resistor.

Pulse (pin 6)

This output pin is normally at a low level, but is momentarily driven high at the beginning of every timing period. The duration of the pulse is fixed at 50 cycles of the clock input (nominally 1 second with a 50Hz input). This output will not assume a high level following a circuit reset until there has been a valid clock transition.

Out (pin 7)

This is the main timing chain output. It has a fixed 50% duty cycle, and begins each timing cycle at a logic low level. Halfway through each cycle, Out will assume a logic high level and will remain high until the end of the timing period.

VSS (pin 8)

Circuit common is connected to this pin. This is the most negative point in the circuit.

Ordering Information

These integrated circuits are available in either the 300 mil plastic DIP format, or in the 200 mil SOIC surface mount type of package. To order, add the appropriate suffix to the part number:

300 mil Plastic DIP..... ELM382P 200 mil SOIC..... ELM382SM

All rights reserved. Copyright ©2000 Elm Electronics. Every effort is made to verify the accuracy of information provided in this document, but no representation or warranty can be given and no liability assumed by Elm Electronics with respect to the accuracy and/or use of any products or information described in this document. Elm Electronics will not be responsible for any patent infringements arising from the use of these products or information, and does not authorize or warrant the use of any Elm Electronics product in life support devices and/or systems. Elm Electronics reserves the right to make changes to the device(s) described in this document in order to improve reliability, function, or design.



Absolute Maximum Ratings

Storage Temperature..... -65°C to +150°C
 Ambient Temperature with
 Power Applied..... -40°C to +85°C
 Voltage on V_{DD} with respect to V_{SS}..... 0 to +7.5V
 Voltage on any other pin with
 respect to V_{SS}..... -0.6V to (V_{DD} + 0.6V)

Note:

Stresses beyond those listed here will likely damage the device. These values are given as a design guideline only. The ability to operate to these levels is neither inferred nor recommended.

Electrical Characteristics

All values are for operation at 25°C and a 5V supply, unless otherwise noted. For further information, refer to note 1 below.

Characteristic	Minimum	Typical	Maximum	Units	Conditions
Supply Voltage, V _{DD}	3.0	5.0	5.5	V	
V _{DD} rate of rise	0.05			V/ms	see note 2
Average Supply Current, I _{DD}		1.0	2.4	mA	V _{DD} = 5V
Internal pullup resistance	300	500	600	K	Pin 4 ($\overline{\text{reset}}$) – see note 3
Reset Pulse Width	10			μs	
Operating Frequency	0	50	10K	Hz	
Input current	-0.5		+0.5	mA	Clock input only – see note 4
Input low voltage	V _{SS}		0.15 V _{DD}	V	
Input high voltage	0.85 V _{DD}		V _{DD}	V	
Output low voltage			0.6	V	Current (sink) = 8.7mA
Output high voltage	V _{DD} - 0.7			V	Current (source) = 5.4mA

Notes:

1. This integrated circuit is produced with a Microchip Technology Inc.'s PIC12C5XX as the core embedded microcontroller. For further device specifications, and possibly clarification of those given, please refer to the appropriate Microchip documentation.
2. This specification must be met in order to ensure that a correct power on reset occurs. It is quite easily achieved using most common types of supplies, but may be violated if one uses a slowly varying supply voltage, as may be obtained through direct connection to solar cells, or some charge pump circuits.
3. The value of the internal pullup resistance is both supply and temperature dependent.
4. This refers to the current flowing through the protection diodes when large voltages are applied to the clock input (pin 5) through a current limiting resistance. Currents quoted are the maximum continuous.

Example Applications

The following shows two circuits using the ELM382. In both cases, it is assumed that the 50Hz for the clock input has been derived from another circuit, with due regard for the safety of the users. Isolating/stepdown transformers should be used whenever possible.

Typically, a sinusoidal AC voltage will be used for the clock signal, with a peak magnitude that is greater than V_{DD} (or less than V_{SS}). For these cases, a series resistor (100K in the figures) must be added to prevent the input currents from exceeding the protection diode capabilities. Another design consideration is the need to provide a DC path from the Clock input back to either V_{DD} or V_{SS} at all times (so the CMOS input is not left floating). As an example, connecting to one side of a centre-tapped transformer that has its centre connected to V_{SS} is an excellent way to obtain a signal, while maintaining a DC path to V_{SS} through the winding. No extra resistor is needed in this case. Connecting to the 'DC side' of a half wave rectifier circuit is likely not advisable however, without adding an extra pulldown resistor to ensure that the voltage returns to V_{SS} when the clock signal is not present. (Recall that a reverse biased diode is essentially an open circuit.)

The first example (Figure 1) is designed to control a swimming pool pump. This circuit is useful for stopping the circulating pump during the night (reducing energy consumption and heat loss), while providing normal operation during the day. The interface to the high voltage pump supply is not shown, but would typically be a transistor stage driving an electromechanical relay circuit.

The pushbutton shown is pressed once on the first day at about 7pm, resetting the circuit. With $D1=H$ and $D0=L$, the circuit will then operate continuously with a 24 hour period, the output (Pump Enable) at a high level from 7am to 7pm, and at a low level otherwise.

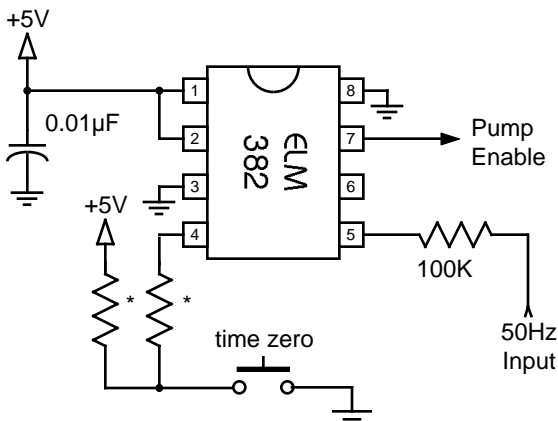

Figure 1. Pool Pump Control Circuit

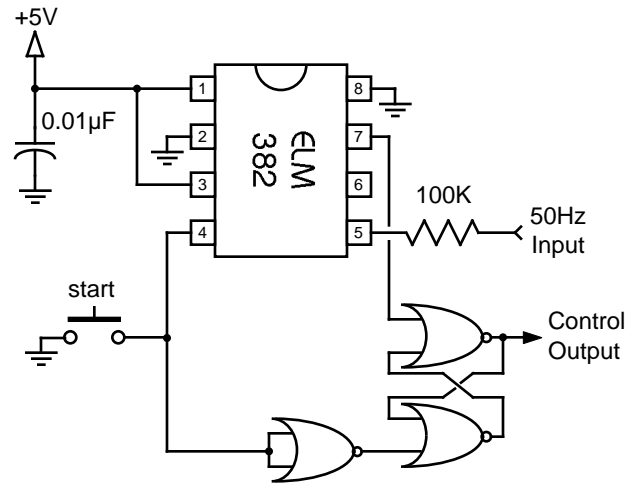

Figure 2. Retriggerable Control Circuit

The two resistors shown with asterisks (*) may be required to reduce the effects of induced charges and currents if the pushbutton is mounted more than a couple of feet from the IC. In this case, protecting resistors (typically about 10K) should be connected as shown.

Figure 2 shows another typical circuit. This one is a retriggerable timer that could be used to control lights, fans, etc. while providing an 'auto-off' feature. For the circuit shown, the control output remains active for a minimum of six hours, but the period is extended each time the start button is pressed.

The ELM382 is inherently an astable circuit that cycles on and off continually, so using it for this 'retriggerable one-shot' operation requires the addition of external latching circuitry as shown. A quad NOR (CMOS 4001) provides the required logic while leaving a fourth gate free for other uses (be sure to tie its inputs to V_{DD} or V_{SS} if unused).

In operation, a new timing period begins whenever the pushbutton is pressed, as it is tied to the reset input. The Control Output latch is also set by this action, forcing a high output. If a half period is ever reached the ELM382 Out signal (pin 7) will go high, resetting the latch and causing a low Control Output. After this time, the ELM382 will continue to cycle, but the Control Output will remain off. As with the circuit of Figure 1, precautions should be taken if the pushbutton is located in an electrically noisy environment, or an appreciable distance from the integrated circuit.

As shown by these two examples, the ELM382 simplifies many long term timing applications, allowing several new possibilities...