

### Features

- Epitaxial Planar Die Construction
- Complementary PNP Types Available (DDTA)
- Built-In Biasing Resistors, R1≠R2

### Mechanical Data

- Case: SC-59, Molded Plastic
- Case material - UL Flammability Rating 94V-0
- Moisture sensitivity: Level 1 per J-STD-020A
- Terminals: Solderable per MIL-STD-202, Method 208
- Terminal Connections: See Diagram
- Marking: Date Code and Marking Code (See Diagrams & Page 3)
- Weight: 0.006 grams (approx.)
- Ordering Information (See Page 2)

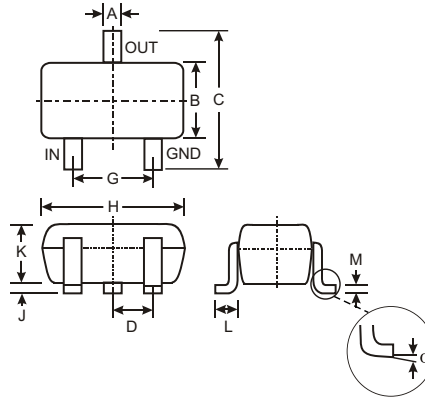

SC-59		
Dim	Min	Max
A	0.35	0.50
B	1.50	1.70
C	2.70	3.00
D	0.95	
G	1.90	
H	2.90	3.10
J	0.013	0.10
K	1.00	1.30
L	0.35	0.55
M	0.10	0.20
$\alpha$	0°	8°
All Dimensions in mm		

P/N	R1 (NOM)	R2 (NOM)	MARKING
DDTC113ZKA	1K $\Omega$	10K $\Omega$	N02
DDTC123YKA	2.2K $\Omega$	10K $\Omega$	N05
DDTC123JKA	2.2K $\Omega$	47K $\Omega$	N06
DDTC143XKA	4.7K $\Omega$	10K $\Omega$	N09
DDTC143FKA	4.7K $\Omega$	22K $\Omega$	N10
DDTC143ZKA	4.7K $\Omega$	47K $\Omega$	N11
DDTC114YKA	10K $\Omega$	47K $\Omega$	N14
DDTC114WKA	10K $\Omega$	4.7K $\Omega$	N15
DDTC124XKA	22K $\Omega$	47K $\Omega$	N18
DDTC144VKA	47K $\Omega$	10K $\Omega$	N21
DDTC144WKA	47K $\Omega$	22K $\Omega$	N22

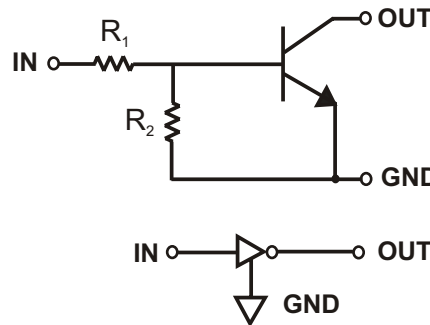

SCHMATIC DIAGRAM

### Maximum Ratings @ T<sub>A</sub> = 25°C unless otherwise specified

Characteristic	Symbol	Value	Unit			
Supply Voltage, (3) to (1)	V <sub>CC</sub>	50	V			
Input Voltage, (2) to (1)	V <sub>IN</sub>	DDTC113ZKA DDTC123YKA DDTC123JKA DDTC143XKA DDTC143FKA DDTC143ZKA DDTC114YKA DDTC114WKA DDTC124XKA DDTC144VKA DDTC144WKA	-5 to +10 -5 to +12 -5 to +12 -7 to +20 -6 to +30 -5 to +30 -6 to +40 -10 to +30 -10 to +40 -15 to +40 -10 to +40	V		
Output Current		I <sub>O</sub>	DDTC113ZKA DDTC123YKA DDTC123JKA DDTC143XKA DDTC143FKA DDTC143ZKA DDTC114YKA DDTC114WKA DDTC124XKA DDTC144VKA DDTC144WKA	100 100 100 100 100 100 70 100 50 30 30	mA	
Output Current			All	I <sub>C</sub> (Max)	100	mA
Power Dissipation			P <sub>d</sub>	200	mW	
Thermal Resistance, Junction to Ambient Air (Note 1)			R <sub>θJA</sub>	625	°C/W	
Operating and Storage and Temperature Range			T <sub>J</sub> , T <sub>STG</sub>	-55 to +150	°C	

Note: 1. Mounted on FR4 PC Board with recommended pad layout at <http://www.diodes.com/datasheets/ap02001.pdf>.

## Electrical Characteristics @ T<sub>A</sub> = 25°C unless otherwise specified

Characteristic		Symbol	Min	Typ	Max	Unit	Test Condition	
Input Voltage	DDTC113ZKA DDTC123YKA DDTC123JKA DDTC143XKA DDTC143FKA DDTC143ZKA DDTC114YKA DDTC114WKA DDTC124XKA DDTC144VKA DDTC144WKA	V <sub>I(off)</sub>	0.3 0.3 0.5 0.3 0.3 0.5 0.3 0.8 0.4 1.0 0.8	—	—	—	V	V <sub>CC</sub> = 5V, I <sub>O</sub> = 100μA
	DDTC113ZKA DDTC123YKA DDTC123JKA DDTC143XKA DDTC143FKA DDTC143ZKA DDTC114YKA DDTC114WKA DDTC124XKA DDTC144VKA DDTC144WKA	V <sub>I(on)</sub>	—	—	3.0 3.0 1.1 2.5 1.3 1.3 1.4 3.0 2.5 5.0 4.0	—	V	V <sub>O</sub> = 0.3V, I <sub>O</sub> = 20mA V <sub>O</sub> = 0.3V, I <sub>O</sub> = 20mA V <sub>O</sub> = 0.3V, I <sub>O</sub> = 5mA V <sub>O</sub> = 0.3V, I <sub>O</sub> = 20mA V <sub>O</sub> = 0.3V, I <sub>O</sub> = 3mA V <sub>O</sub> = 0.3V, I <sub>O</sub> = 5mA V <sub>O</sub> = 0.3V, I <sub>O</sub> = 1mA V <sub>O</sub> = 0.3V, I <sub>O</sub> = 2mA V <sub>O</sub> = 0.3V, I <sub>O</sub> = 2mA V <sub>O</sub> = 0.3V, I <sub>O</sub> = 2mA
Output Voltage		V <sub>O(on)</sub>	—	0.1	0.3	V	I <sub>O</sub> /I <sub>I</sub> = 5mA/0.25mA DDTC123JKA I <sub>O</sub> /I <sub>I</sub> = 5mA/0.25mA DDTC143ZKA I <sub>O</sub> /I <sub>I</sub> = 5mA/0.25mA DDTC114YKA I <sub>O</sub> /I <sub>I</sub> = 10mA/0.5mA All Others	
Input Current	DDTC113ZKA DDTC123YKA DDTC123JKA DDTC143XKA DDTC143FKA DDTC143ZKA DDTC114YKA DDTC114WKA DDTC124XKA DDTC144VKA DDTC144WKA	I <sub>I</sub>	—	—	7.2 3.8 3.6 1.8 1.8 1.8 0.88 0.88 0.36 0.16 0.16	mA	V <sub>I</sub> = 5V	
Output Current		I <sub>O(off)</sub>	—	—	0.5	μA	V <sub>CC</sub> = 50V, V <sub>I</sub> = 0V	
DC Current Gain	DDTC113ZKA DDTC123YKA DDTC123JKA DDTC143XKA DDTC143FKA DDTC143ZKA DDTC114YKA DDTC114WKA DDTC124XKA DDTC144VKA DDTC144WKA	G <sub>I</sub>	33 33 80 30 68 80 68 24 68 33 56	—	—	—	V <sub>O</sub> = 5V, I <sub>O</sub> = 10mA	
Input Resistor Tolerance		DR <sub>1</sub>	-30	—	+30	%	—	
Resistance Ratio Tolerance		DR <sub>2</sub> /R <sub>1</sub>	-20	—	+20	%	—	
Gain-Bandwidth Product*		f <sub>T</sub>	—	250	—	MHz	V <sub>CE</sub> = 10V, I <sub>E</sub> = 5mA, f = 100MHz	

\* Transistor - For Reference Only

## Ordering Information (Note 2)

Device	Packaging	Shipping
DDTC113ZKA-7	SC-59	3000/Tape & Reel
DDTC123YKA-7	SC-59	3000/Tape & Reel
DDTC123JKA-7	SC-59	3000/Tape & Reel
DDTC143XKA-7	SC-59	3000/Tape & Reel
DDTC143FKA-7	SC-59	3000/Tape & Reel
DDTC143ZKA-7	SC-59	3000/Tape & Reel
DDTC114YKA-7	SC-59	3000/Tape & Reel
DDTC114WKA-7	SC-59	3000/Tape & Reel
DDTC124XKA-7	SC-59	3000/Tape & Reel
DDTC144VKA-7	SC-59	3000/Tape & Reel
DDTC144WKA-7	SC-59	3000/Tape & Reel

Notes: 2. For Packaging Details, go to our website at <http://www.diodes.com/datasheets/ap02007.pdf>.

**Marking Information**

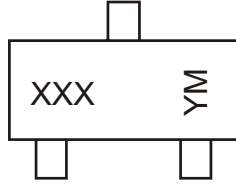

XXX = Product Type Marking Code  
 See Sheet 1 Diagrams  
 YM = Date Code Marking  
 Y = Year ex: N = 2002  
 M = Month ex: 9 = September

Date Code Key

<b>Year</b>	<b>2002</b>	<b>2003</b>	<b>2004</b>	<b>2005</b>	<b>2006</b>	<b>2007</b>	<b>2008</b>	<b>2009</b>
<b>Code</b>	N	P	R	S	T	U	V	W

<b>Month</b>	<b>Jan</b>	<b>Feb</b>	<b>March</b>	<b>Apr</b>	<b>May</b>	<b>Jun</b>	<b>Jul</b>	<b>Aug</b>	<b>Sep</b>	<b>Oct</b>	<b>Nov</b>	<b>Dec</b>
<b>Code</b>	1	2	3	4	5	6	7	8	9	O	N	D

TYPICAL CURVES - DDTC123JKA

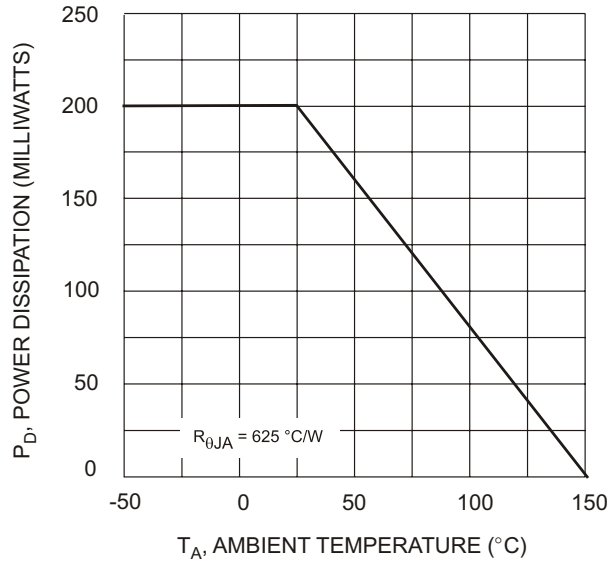

Fig. 1 Derating Curve

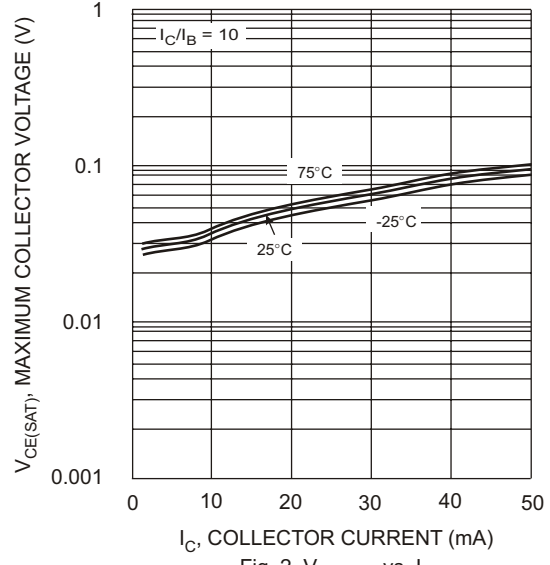

Fig. 2  $V_{CE(SAT)}$  vs.  $I_C$

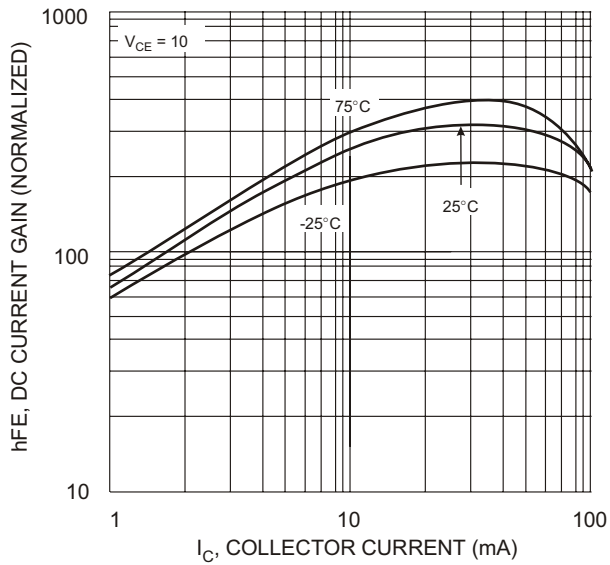

Fig. 3 DC CURRENT GAIN

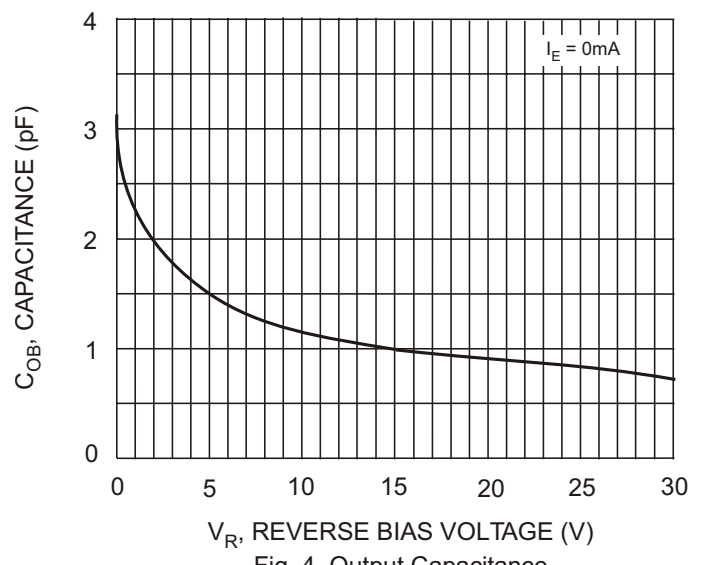

Fig. 4 Output Capacitance

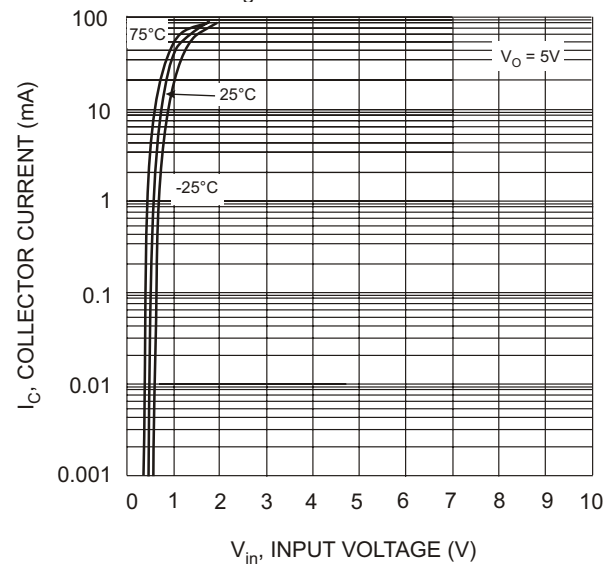

Fig. 5 Collector Current Vs. Input Voltage

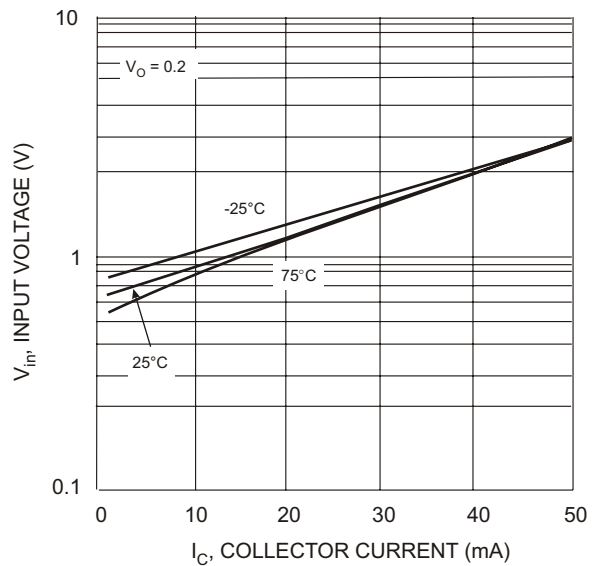

Fig. 6 Input Voltage vs. Collector Current