

Features

- Epitaxial Planar Die Construction
- Complementary NPN Types Available (DDTC)
- Built-In Biasing Resistors, R1≠R2

Mechanical Data

- Case: SOT-23, Molded Plastic
- Case material - UL Flammability Rating 94V-0
- Moisture sensitivity: Level 1 per J-STD-020A
- Terminals: Solderable per MIL-STD-202, Method 208
- Terminal Connections: See Diagram
- Marking: Date Code and Marking Code (See Diagrams & Page 3)
- Weight: 0.008 grams (approx.)

P/N	R1 (NOM)	R2 (NOM)	MARKING
DDTA113ZCA	1KΩ	10KΩ	P02
DDTA123YCA	2.2KΩ	10KΩ	P05
DDTA123JCA	2.2KΩ	47KΩ	P06
DDTA143XCA	4.7KΩ	10KΩ	P09
DDTA143FCA	4.7KΩ	22KΩ	P10
DDTA143ZCA	4.7KΩ	47KΩ	P11
DDTA114YCA	10KΩ	47KΩ	P14
DDTA114WCA	10KΩ	4.7KΩ	P15
DDTA124XCA	22KΩ	47KΩ	P18
DDTA144VCA	47KΩ	10KΩ	P21
DDTA144WCA	47KΩ	22KΩ	P22

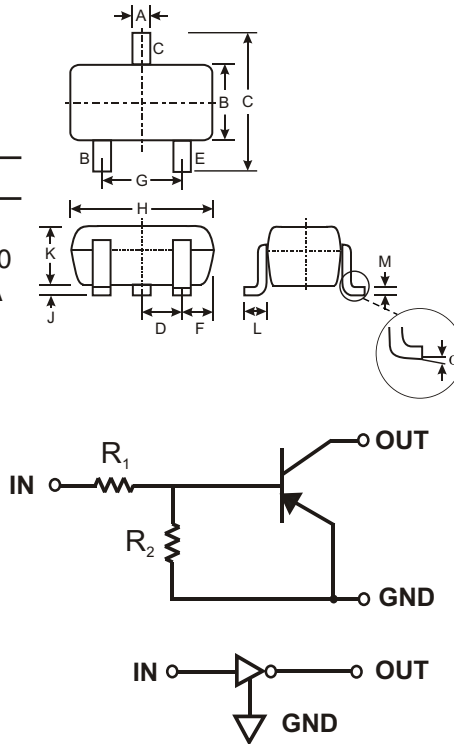

SOT-23		
Dim	Min	Max
A	0.37	0.51
B	1.20	1.40
C	2.30	2.50
D	0.89	1.03
E	0.45	0.60
G	1.78	2.05
H	2.80	3.00
J	0.013	0.10
K	0.903	1.10
L	0.45	0.61
M	0.85	0.80
α	0°	8°
All Dimensions in mm		

SCHEMATIC DIAGRAM

Maximum Ratings @ T_A = 25°C unless otherwise specified

Characteristic	Symbol	Value	Unit
Supply Voltage, (3) to (1)	V _{CC}	-50	V
Input Voltage, (2) to (1)	V _{IN}	+5 to -10 +5 to -12 +5 to -12 +7 to -20 +6 to -30 +5 to -30 +6 to -40 +10 to -30 +10 to -40 +15 to -40 +10 to -40	V
Output Current	I _O	-100 -100 -100 -100 -100 -100 -70 -100 -50 -30 -30	mA
Output Current	I _C (Max)	-100	mA
Power Dissipation	P _d	200	mW
Thermal Resistance, Junction to Ambient Air (Note 1)	R _{θJA}	625	°C/W
Operating and Storage and Temperature Range	T _J , T _{STG}	-55 to +150	°C

Note: 1. Mounted on FR4 PC Board with recommended pad layout at <http://www.diodes.com/datasheets/ap02001.pdf>.

Electrical Characteristics @ T_A = 25°C unless otherwise specified

Characteristic		Symbol	Min	Typ	Max	Unit	Test Condition	
Input Voltage	DDTA113ZCA DDTA123YCA DDTA123JCA DDTA143XCA DDTA143FCA DDTA143ZCA DDTA114YCA DDTA114WCA DDTA124XCA DDTA144VCA DDTA144WCA	V _{I(off)}	-0.3 -0.3 -0.5 -0.3 -0.3 -0.5 -0.3 -0.8 -0.4 -1.0 -0.8	—	—	—	V	V _{CC} = 5V, I _O = 100μA
	DDTA113ZCA DDTA123YCA DDTA123JCA DDTA143XCA DDTA143FCA DDTA143ZCA DDTA114YCA DDTA114WCA DDTA124XCA DDTA144VCA DDTA144WCA	V _{I(on)}	—	—	-3.0 -3.0 -1.1 -2.5 -1.3 -1.3 -1.4 -3.0 -2.5 -5.0 -4.0	—	V	V _O = -0.3V, I _O = -20mA V _O = -0.3V, I _O = -20mA V _O = -0.3V, I _O = -5mA V _O = -0.3V, I _O = -20mA V _O = -0.3V, I _O = -3mA V _O = -0.3V, I _O = -5mA V _O = -0.3V, I _O = -1mA V _O = -0.3V, I _O = -2mA V _O = -0.3V, I _O = -2mA V _O = -0.3V, I _O = -2mA V _O = -0.3V, I _O = -2mA
Output Voltage		V _{O(on)}	—	-0.1	-0.3	V	I _O /I _I = -5mA/-0.25mA DDTA123JCA I _O /I _I = -5mA/-0.25mA DDTA143ZCA I _O /I _I = -5mA/-0.25mA DDTA114YCA I _O /I _I = -10mA/-0.5mA All Others	
Input Current	DDTA113ZCA DDTA123YCA DDTA123JCA DDTA143XCA DDTA143FCA DDTA143ZCA DDTA114YCA DDTA114WCA DDTA124XCA DDTA144VCA DDTA144WCA	I _I	—	—	-7.2 -3.8 -3.6 -1.8 -1.8 -1.8 -0.88 -0.88 -0.36 -0.16 -0.16	mA	V _I = -5V	
Output Current		I _{O(off)}	—	—	-0.5	μA	V _{CC} = -50V, V _I = 0V	
DC Current Gain	DDTA113ZCA DDTA123YCA DDTA123JCA DDTA143XCA DDTA143FCA DDTA143ZCA DDTA114YCA DDTA114WCA DDTA124XCA DDTA144VCA DDTA144WCA	G _I	-33 -33 -80 -30 -68 -80 -68 -24 -68 -33 -56	—	—	—	V _O = -5V, I _O = -10mA	
Input Resistor Tolerance		DR ₁	-30	—	+30	%	—	
Resistance Ratio Tolerance		DR ₂ /R ₁	-20	—	+20	%	—	
Gain-Bandwidth Product*		f _T	—	250	—	MHz	V _{CE} = -10V, I _E = 5mA, f = 100MHz	

* Transistor - For Reference Only

Ordering Information (Note 2)

Device	Packaging	Shipping
DDTA113ZCA-7	SOT-23	3000/Tape & Reel
DDTA123YCA-7	SOT-23	3000/Tape & Reel
DDTA123JCA-7	SOT-23	3000/Tape & Reel
DDTA143XCA-7	SOT-23	3000/Tape & Reel
DDTA143FCA-7	SOT-23	3000/Tape & Reel
DDTA143ZCA-7	SOT-23	3000/Tape & Reel
DDTA114YCA-7	SOT-23	3000/Tape & Reel
DDTA114WCA-7	SOT-23	3000/Tape & Reel
DDTA124XCA-7	SOT-23	3000/Tape & Reel
DDTA144VCA-7	SOT-23	3000/Tape & Reel
DDTA144WCA-7	SOT-23	3000/Tape & Reel

Notes: 2. For Packaging Details, go to our website at <http://www.diodes.com/datasheets/ap02007.pdf>.

Marking Information

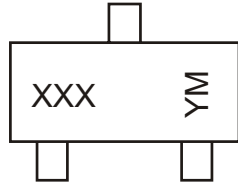

XXX = Product Type Marking Code
 See Sheet 1 Diagrams
 YM = Date Code Marking
 Y = Year ex: N = 2002
 M = Month ex: 9 = September

Date Code Key

Year	2002	2003	2004	2005	2006	2007	2008	2009
Code	N	P	R	S	T	U	V	W

Month	Jan	Feb	March	Apr	May	Jun	Jul	Aug	Sep	Oct	Nov	Dec
Code	1	2	3	4	5	6	7	8	9	O	N	D

TYPICAL CURVES - DDTA123JCA

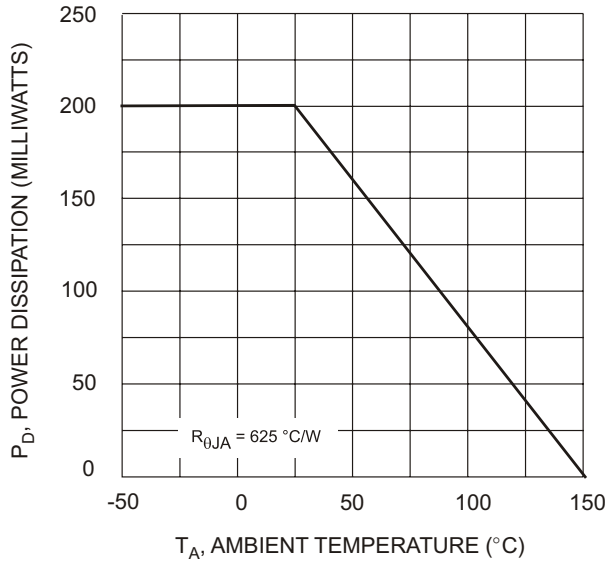

Fig. 1 Derating Curve

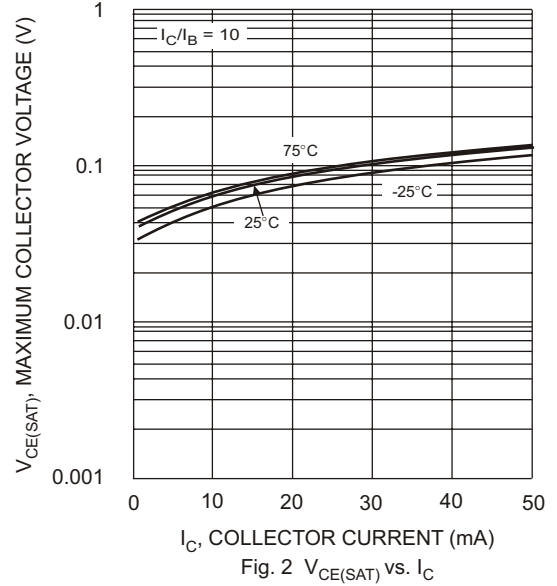

Fig. 2 $V_{CE(SAT)}$ vs. I_C

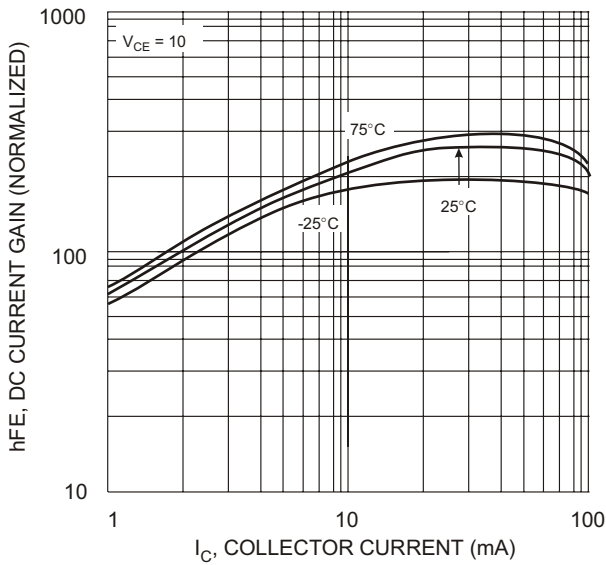

Fig. 3 DC CURRENT GAIN

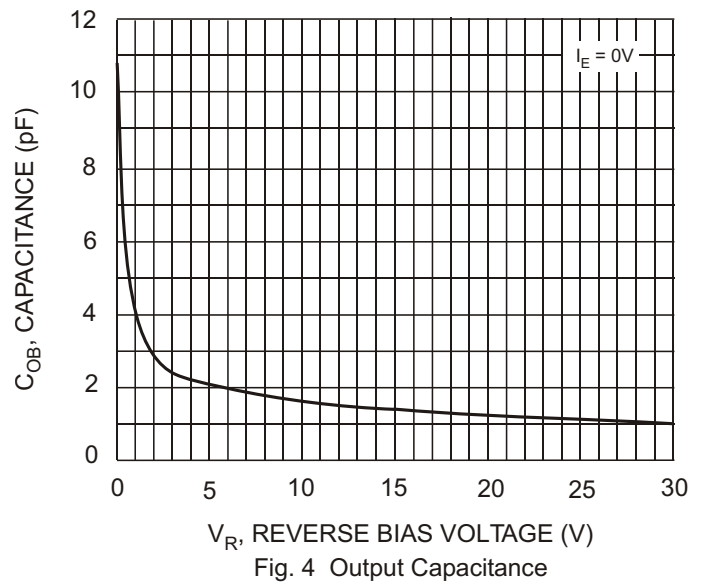

Fig. 4 Output Capacitance

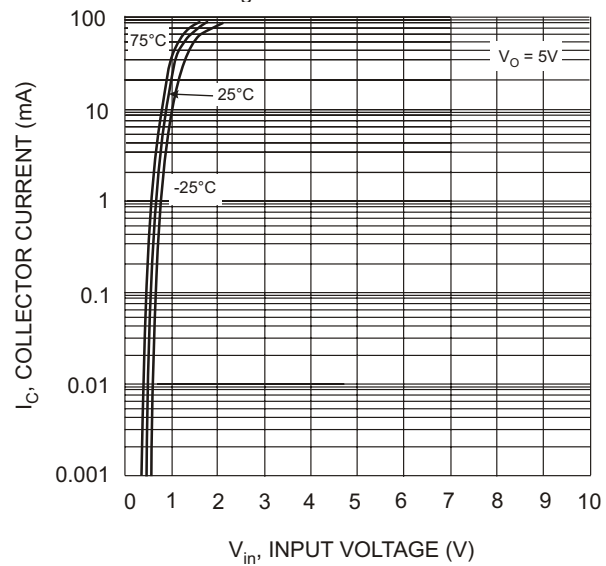

Fig. 5 Collector Current Vs. Input Voltage

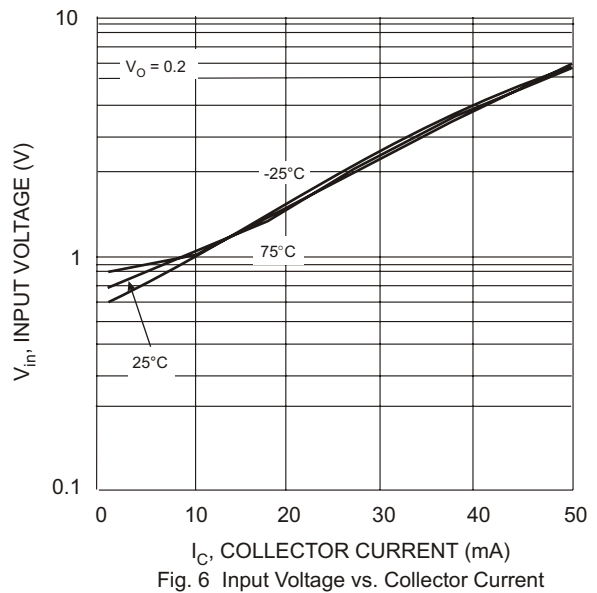

Fig. 6 Input Voltage vs. Collector Current