



**DC COMPONENTS CO., LTD.**

RECTIFIER SPECIALISTS

**HSM101  
THRU  
HSM106**

**TECHNICAL SPECIFICATIONS OF SURFACE MOUNT HIGH EFFICIENCY RECTIFIER**

**VOLTAGE RANGE - 50 to 600 Volts**

**CURRENT - 1.0 Ampere**

**FEATURES**

- \* Ideal for surface mounted applications
- \* Low leakage current
- \* Fast switching for high efficiency
- \* Glass passivated junction

**MECHANICAL DATA**

- \* Case: Molded plastic
- \* Epoxy: UL 94V-0 rate flame retardant
- \* Terminals: Solder plated solderable per MIL-STD-202E, Method 208 guaranteed
- \* Polarity: Color band denotes cathode end
- \* Mounting position: Any
- \* Weight: 0.12 gram

**MAXIMUM RATINGS AND ELECTRICAL CHARACTERISTICS**

Ratings at 25 °C ambient temperature unless otherwise specified.  
Single phase, half wave, 60 Hz, resistive or inductive load.  
For capacitive load, derate current by 20%.



SM-1(DO-213AB)

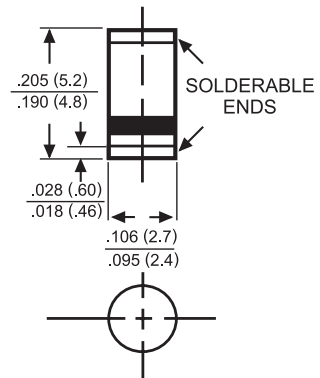

Dimensions in inches and (millimeters)

	SYMBOL	HSM101	HSM102	HSM103	HSM104	HSM105	HSM106	UNITS
Maximum Recurrent Peak Reverse Voltage	V <sub>RRM</sub>	50	100	200	300	400	600	Volts
Maximum RMS Volts	V <sub>RMS</sub>	35	70	140	210	280	420	Volts
Maximum DC Blocking Voltage	V <sub>DC</sub>	50	100	200	300	400	600	Volts
Maximum Average Forward Current at T <sub>A</sub> = 50°C	I <sub>O</sub>	1.0						Amps
Peak Forward Surge Current 8.3 ms single half sine-wave superimposed on rated load (JEDEC Method)	I <sub>FSM</sub>	30						Amps
Maximum Instantaneous Forward Voltage at 1.0A DC	V <sub>F</sub>	1.0		1.3		1.7		Volts
Maximum DC Reverse Current at Rated DC Blocking Voltage	I <sub>R</sub>	5.0						uAmps
		100						
Maximum Reverse Recovery Time (Note 1)	t <sub>rr</sub>	50				75		nSec
Typical Junction Capacitance (Note 2)	C <sub>J</sub>	15						pF
Operating and Storage Temperature Range	T <sub>J</sub> , T <sub>STG</sub>	-65 to + 175						°C

NOTES : 1. Test Conditions: I<sub>F</sub>=0.5A, I<sub>R</sub>=1.0A, I<sub>RR</sub>=0.25A.  
2. Measured at 1 MHz and applied reverse voltage of 4.0 volts.

# RATING AND CHARACTERISTIC CURVES ( HSM101 THRU HSM106 )

FIG. 1 - TEST CIRCUIT DIAGRAM AND REVERSE RECOVERY TIME CHARACTERISTIC

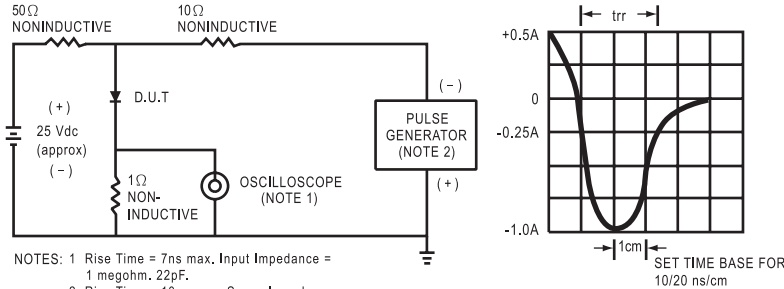

FIG. 2 - TYPICAL FORWARD CURRENT DERATING CURVE

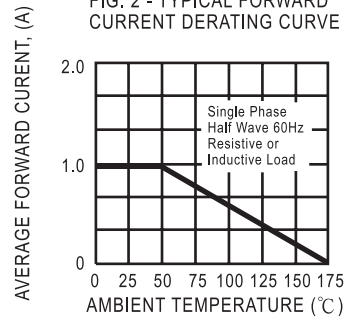

FIG. 3 - TYPICAL REVERSE CHARACTERISTICS

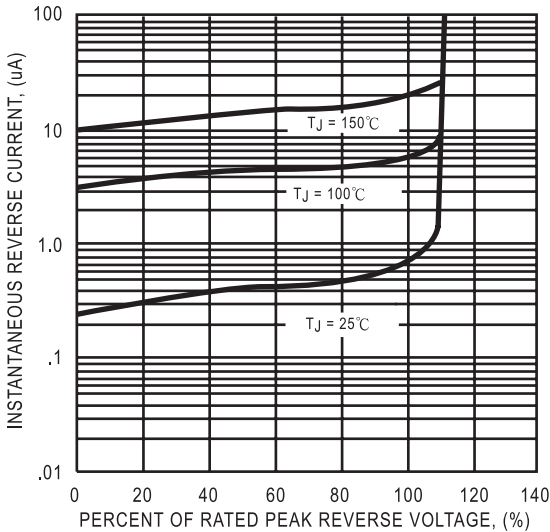

FIG. 4 - TYPICAL INSTANTANEOUS FORWARD CHARACTERISTICS

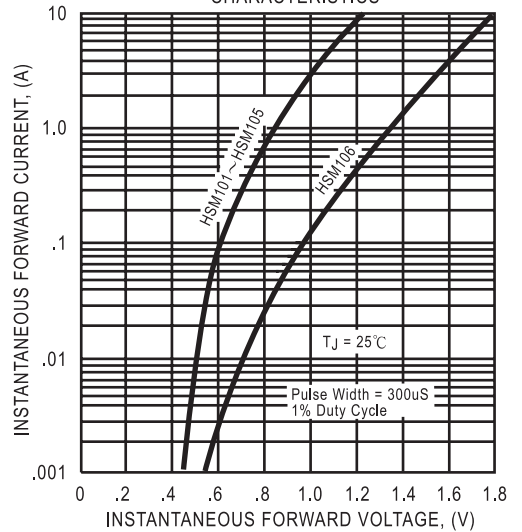

FIG. 5 - MAXIMUM NON-REPETITIVE FORWARD SURGE CURRENT

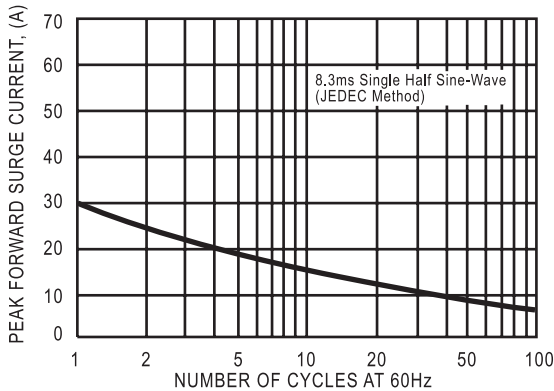
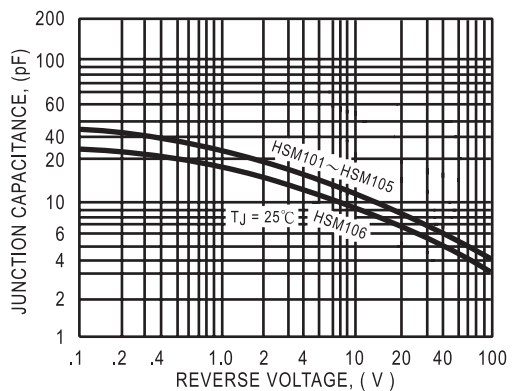

FIG. 6 - TYPICAL JUNCTION CAPACITANCE



DC COMPONENTS CO., LTD.