



DC COMPONENTS CO., LTD.

RECTIFIER SPECIALISTS

**1N4933
THRU
1N4937**

TECHNICAL SPECIFICATIONS OF FAST RECOVERY RECTIFIER
VOLTAGE RANGE - 50 to 600 Volts **CURRENT - 1.0 Ampere**

FEATURES

- * Low cost
- * Low leakage
- * Low forward voltage drop
- * High current capability

MECHANICAL DATA

- * Case: Molded plastic
- * Epoxy: UL 94V-0 rate flame retardant
- * Lead: MIL-STD-202E, Method 208 guaranteed
- * Mounting position: Any
- * Weight: 0.33 gram

MAXIMUM RATINGS AND ELECTRICAL CHARACTERISTICS

Ratings at 25 °C ambient temperature unless otherwise specified.
 Single phase, half wave, 60 Hz, resistive or inductive load.
 For capacitive load, derate current by 20%.



DO-41

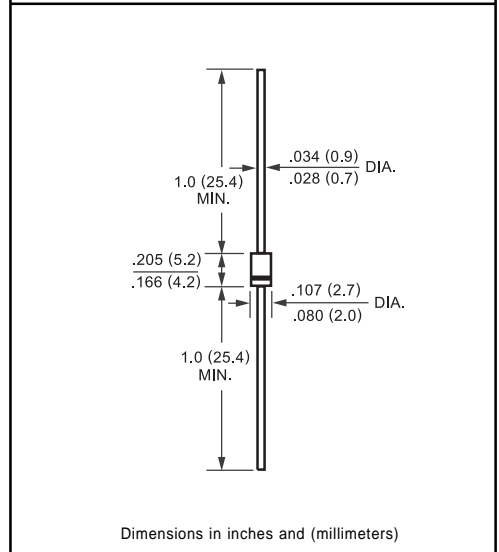

Dimensions in inches and (millimeters)

	SYMBOL	1N4933	1N4934	1N4935	1N4936	1N4937	UNITS
Maximum Recurrent Peak Reverse Voltage	V _{RRM}	50	100	200	400	600	Volts
Maximum RMS Voltage	V _{RMS}	35	70	140	280	420	Volts
Maximum DC Blocking Voltage	V _{DC}	50	100	200	400	600	Volts
Maximum Average Forward Rectified Current at T _A = 75°C	I _O	1.0					Amps
Peak Forward Surge Current 8.3 ms single half sine-wave superimposed on rated load (JEDEC Method)	I _{FSM}	30					Amps
Maximum Instantaneous Forward Voltage at 1.0A DC	V _F	1.3					Volts
Maximum DC Reverse Current at Rated DC Blocking Voltage T _A = 25°C	I _R	5.0					uAmps
Maximum Full Load Reverse Current Full Cycle Average, .375"(9.5mm) lead length at T _L = 55°C		100					uAmps
Maximum Reverse Recovery Time (Note 1)	t _{rr}	150			250		nSec
Typical Junction Capacitance (Note 2)	C _J	15					pF
Operating and Storage Temperature Range	T _J , T _{STG}	-65 to + 150					°C

NOTES : 1. Test Conditions: I_F = 0.5A, I_R = 1.0A, I_{RR} = 0.25A
 2. Measured at 1 MHz and applied reverse voltage of 4.0 volts

RATING AND CHARACTERISTIC CURVES (1N4933 THRU 1N4937)

FIG. 1 - TYPICAL FORWARD CURRENT DERATING CURVE

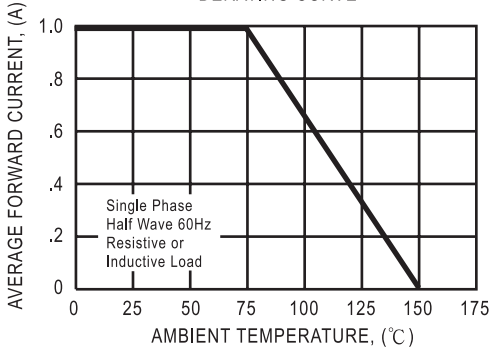

FIG. 2 - MAXIMUM NON-REPETITIVE FORWARD SURGE CURRENT

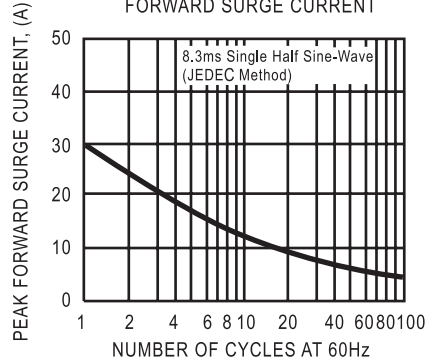

FIG. 3 - TYPICAL JUNCTION CAPACITANCE

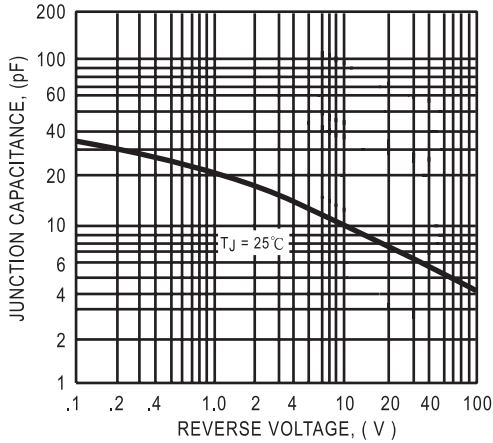

FIG. 4 - TYPICAL INSTANTANEOUS FORWARD CHARACTERISTICS

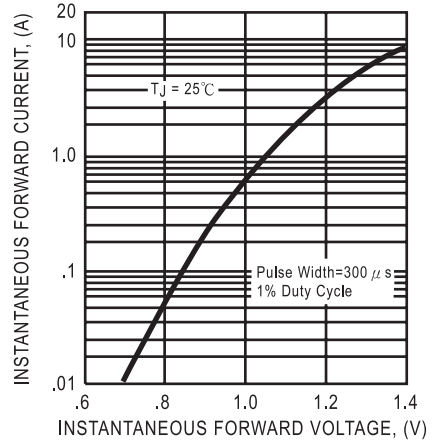
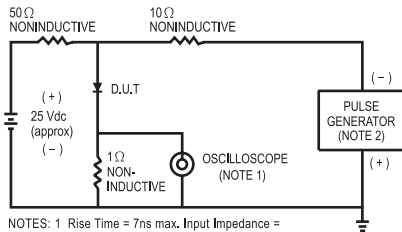
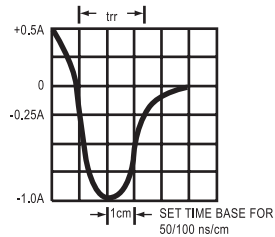

FIG. 5 - TEST CIRCUIT DIAGRAM AND REVERSE RECOVERY TIME CHARACTERISTIC



NOTES: 1. Rise Time = 7ns max. Input Impedance = 1 megohm, 22pF.
2. Rise Time = 10ns max. Source Impedance = 50 ohms.



DC COMPONENTS CO., LTD.