



## Triple Output TPB Models

### High-Efficiency, Smaller-Package 25-40 Watt, DC/DC Converters

#### Features

- 25/30/35/40W output power
- Standard pinout! Smaller size!
- New 2" x 3" package fits 3" x 3" footprint
- Output voltages: +5V/±12V or +5V/±15V
- Four input voltage ranges:  
10-36V, 18-36V  
18-72V, 36-72V
- High efficiencies (to 86%)
- Fully isolated, 750Vdc guaranteed
- Thermal shutdown
- $V_{OUT}$  trim and on/off control
- Safety approvals pending
- Modifications and customs for OEM's

DATEL's TPB Model, 25-40 Watt, triple-output DC/DC power converters bring you efficient "on-board" power processing in a cost-effective smaller package with a standard pinout. The 2" x 3" TPB "footprint" conforms with the industry-standard pinout and pin geometries of most 3" x 3" devices (a 33% space savings) while delivering as much as 60% more power (40W vs. 25W).

Applicable to a wide range of telecom, computer and other OEM applications, TPB Model DC/DC's operate from four input voltage ranges (10-36V for "Q12" models, 18-36V for "D24" models, 18-72V for "Q48" models, and 36-72V for "D48" models). Available output voltages are +5 and ±12V or +5 and ±15V.

For improved reliability and affordability, DATEL uses contemporary, high-speed, automatic-assembly techniques to construct the TPB's traditional, field-proven, SMT-on-pcb designs. Devices employ corrosion-resistant steel cases with heavy zinc top plates (traditionally referred to as baseplates). Heat generating transformer cores and power semiconductors are mounted directly to the baseplates, which also have threaded inserts for add-on heat sinks or pcb mounting. Temperature derating information is provided for operation with and without heat sinks and forced air flow.

All devices feature input pi filters, input overvoltage shutdown, output overvoltage protection, output current limiting, and thermal shutdown. All units are temperature cycled, burned in and automatically tested prior to shipment. UL, CSA, EN and IEC compliance testing is currently under way as are full EMI/EMC characterizations.

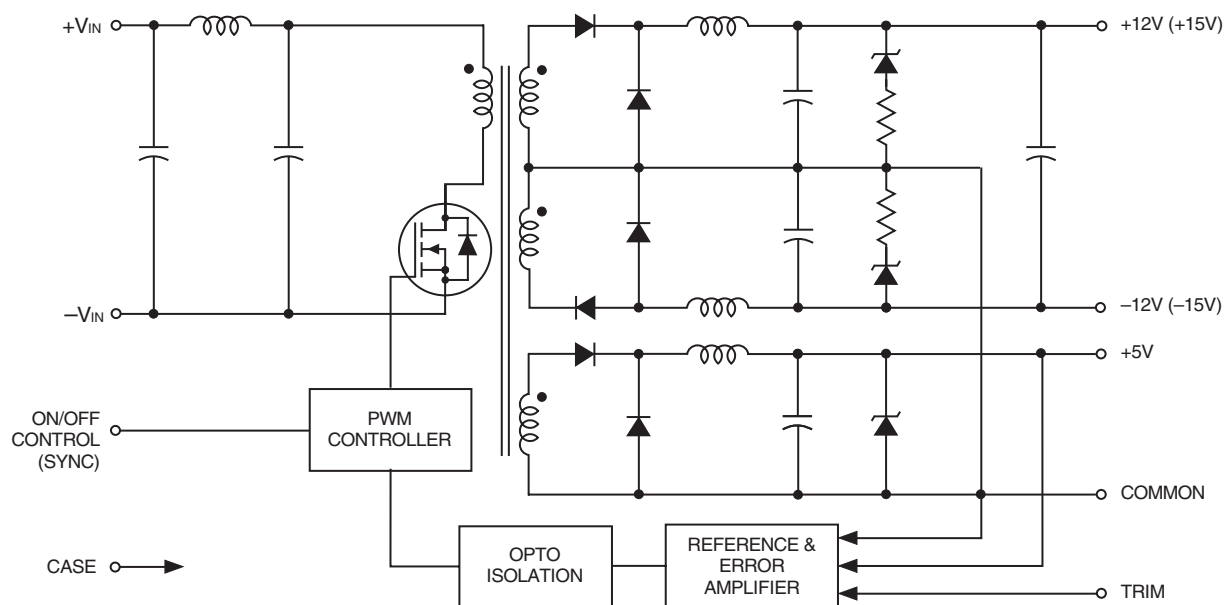


Figure 1. Simplified Schematic

**Performance Specifications and Ordering Guide** ①

Model	Output						Input			Efficiency		Package (Case, Pinout)
	V <sub>OUT</sub> (Volts)	I <sub>OUT</sub> (Amps)	R/N (mVp-p) ②		Regulation (Max.)		V <sub>IN</sub> Nom. (Volts)	Range (Volts)	I <sub>IN</sub> ④ (mA)	Min.	Typ.	
			Typ.	Max.	Line	Load ③						
TPB-5/5-12/1-Q12	+5	5	75	125	±1%	±1.5%	24	10-36	35/1240	82%	84%	C10, P16
	±12	±1	100	120	±1.5%	±8%						
TPB-5/5-12/1-D24	+5	5	75	125	±1%	±1.5%	24	18-36	35/1716	83%	85%	C10, P16
	±12	±1	100	120	±1.5%	±8%						
TPB-5/5-12/1-Q48	+5	5	75	125	±1%	±1.5%	48	18-72	20/737	82%	85%	C10, P16
	±12	±1	100	120	±1.5%	±8%						
TPB-5/5-12/1-D48	+5	5	75	125	±1%	±1.5%	48	36-72	25/967	83%	86%	C10, P16
	±12	±1	100	120	±1.5%	±8%						
TPB-5/5-15/1-Q12	+5	5	75	125	±1%	±1.5%	24	10-36	35/1238	82%	85%	C10, P16
	±15	±1	120	150	±1.5%	±8%						
TPB-5/5-15/1-D24	+5	5	75	125	±1%	±1.5%	24	18-36	35/1696	83%	86%	C10, P16
	±15	±1	120	150	±1.5%	±8%						
TPB-5/5-15/1-Q48	+5	5	75	125	±1%	±1.5%	48	18-72	20/735	82%	85%	C10, P16
	±15	±1	120	150	±1.5%	±8%						
TPB-5/5-15/1-D48	+5	5	75	125	±1%	±1.5%	48	36-72	25/981	83%	85%	C10, P16
	±15	±1	120	150	±1.5%	±8%						

① Typical at T<sub>A</sub> = +25°C under nominal line voltage and "full-load" conditions unless otherwise noted. The specific combination of primary and auxiliary currents comprising "full load" varies with part number. See Output Power Considerations and Technical Notes for more details.

② Ripple/Noise (R/N) measured over a 20MHz bandwidth.

③ 10-100% load on the primary +5V output, 20-100% balanced loads on the auxiliary outputs.

④ Nominal line voltage, no-load/full-load conditions.

**PART NUMBER STRUCTURE**

**TPB-5/5-12/1-D48**

Output Configuration:  
T = Triple

Power Package with  
Metal Baseplate

Nominal Primary Output  
Voltage (+5 Volts)

Maximum Primary Output  
Current in Amps

Input Voltage Range:

Q12 = 10-36 Volts (24V nom.)

D24 = 18-36 Volts (24V nom.)

Q48 = 18-72 Volts (48V nom.)

D48 = 36-72 Volts (48V nom.)

Maximum Auxiliary Output  
Currents in Amps from each output

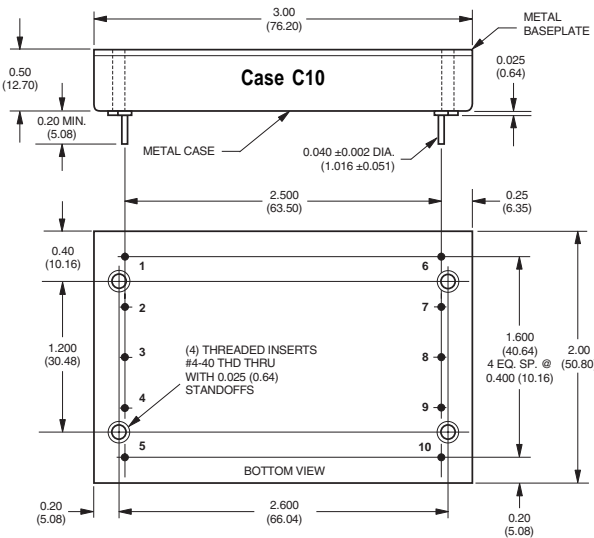
Nominal Auxiliary Output  
Voltages (±12 or ±15 Volts)

**OUTPUT POWER CONSIDERATIONS**

As shown below, TPB Model DC/DC Converters are classified by output power. For triple-output devices, the sum of the output power from the primary +5V output plus that from the two auxiliary (±12V or ±15V) outputs can not exceed the rated power. For example, "D24" models have a maximum power of 35W. Therefore, if you source the maximum primary current of 5A, the devices will only be able to provide 10W of total power from their auxiliary outputs.

Model	Maximum Output Power
Q12	25 Watts
Q48	30 Watts
D24	35 Watts
D48	40 Watts

**MECHANICAL SPECIFICATIONS**

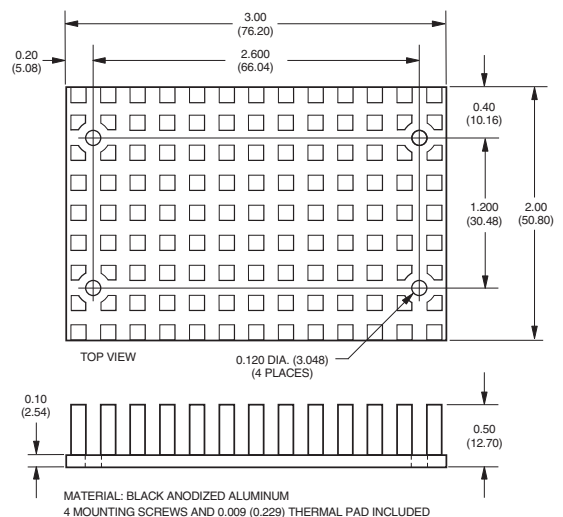


**I/O Connections**

Pin	Function P16
1	No Pin
2	-Input
3	+Input
4	Case
5	On/Off Control*
6	-12V/15V Out
7	+12V/15V Out
8	Common
9	+5V Out
10	Trim

\* See note 4 on next page.

**Optional Heat Sink (Part Number HS-23)**



**Performance/Functional Specifications**

Typical @ T<sub>A</sub> = +25°C under nominal line voltage and "full-load" conditions, unless noted. ① ②

Input	
<b>Input Voltage Range:</b>	
Q12 Models	10-36 Volts (24V nominal)
D24 Models	18-36 Volts (24V nominal)
Q48 Models	18-72 Volts (48V nominal)
D48 Models	36-72 Volts (48V nominal)
<b>Input Current</b>	See Ordering Guide
<b>Input Filter Type</b> ③	Pi
<b>Overvoltage Shutdown:</b>	
Q12 and D24 Models	40 Volts
Q48 and D48 Models	80 Volts
<b>Reverse-Polarity Protection</b>	Yes (Instantaneous, 6A maximum)
<b>On/Off Control (Pin 5)</b> ④	TTL high (or open) = on, low = off
Output	
<b>V<sub>OUT</sub> Accuracy (50% load):</b>	
+5V Output	±1%
±12V or ±15V Outputs	±3%
<b>Temperature Coefficient</b>	±0.02% per °C
<b>Ripple/Noise (20MHz BW)</b> ③	See Ordering Guide
<b>Line/Load Regulation</b>	See Ordering Guide
<b>Efficiency</b>	See Ordering Guide
<b>Isolation Voltage</b>	750Vdc, minimum
<b>Isolation Capacitance</b>	500pF
<b>Current Limiting</b>	Continuous, auto-recovery
<b>Overvoltage Protection</b>	Zener/transorb clamps, magnetic fdbk.
Dynamic Characteristics	
<b>Transient Response (50% load step)</b>	300µsec max. to ±3% of final value
<b>Switching Frequency</b>	125kHz (±10%)
Environmental	
<b>Operating Temperature (ambient):</b>	
Without Derating	-25 to +50°C (Model dependent)
With Derating	to +95°C
Maximum Baseplate Temperature	+95°C
<b>Storage Temperature</b>	-40 to +105°C
Physical	
<b>Dimensions</b>	2" x 3" x 0.5" (50.8 x 76.2 x 12.7mm)
<b>Shielding</b>	6-sided
<b>Case Connection</b>	Pin 4
<b>Case Material</b>	Bright tin-plated steel
<b>Baseplate Material</b>	Aluminum
<b>Pin Material</b>	Brass, solder coated
<b>Weight</b>	4 ounces (113 grams)

Absolute Maximum Ratings	
<b>Input Voltage:</b>	
Q12/D24 Models	44 Volts
Q48/D48 Models	88 Volts
<b>Input Reverse-Polarity Protection</b>	Current must be <6A. Brief duration only. Fusing recommended.
<b>Output Overvoltage Protection</b>	
+5V Output	6.8 Volts, limited duration
±12V Outputs	15 Volts, limited duration
±15V Outputs	18 Volts, limited duration
<b>Output Current</b>	Current limited. Max. current and short-circuit duration are model dependent.
<b>Storage Temperature</b>	-40 to +105°C
<b>Lead Temperature (soldering, 10 sec.)</b>	+300°C
These are stress ratings. Exposure of devices to any of these conditions may adversely affect long-term reliability. Proper operation under conditions other than those listed in the Performance/Functional Specifications Table is not implied.	

TECHNICAL NOTES

**Filtering and Noise Reduction**

All TPB 25-40 Watt DC/DC Converters achieve their rated ripple and noise specifications without the use of external input/output capacitors. In critical applications, input/output ripple and noise may be further reduced by installing electrolytic capacitors across the input terminals and/or low-ESR tantalum or electrolytic capacitors across the output terminals. Output capacitors should be connected between their respective output pin (pin 6, 7 or 9) and Common (pin 8). The caps should be located as close to the power converters as possible. See Figure 7. Typical values are listed in the tables below. In many applications, using values greater than those listed will yield better results.

**To Reduce Input Ripple**

Q12, D24 Models	47µF, 50V
Q48, D48 Models	10µF, 100V

**To Reduce Output Ripple**

+5V Output	47µF, 10V, Low ESR
±12/15V Outputs	22µF, 20V, Low ESR

In critical, space-sensitive applications, DATEL may be able to tailor the internal input/output filtering of these devices to meet your specific requirements. Contact our Applications Engineering Group for additional details.

**Input Fusing**

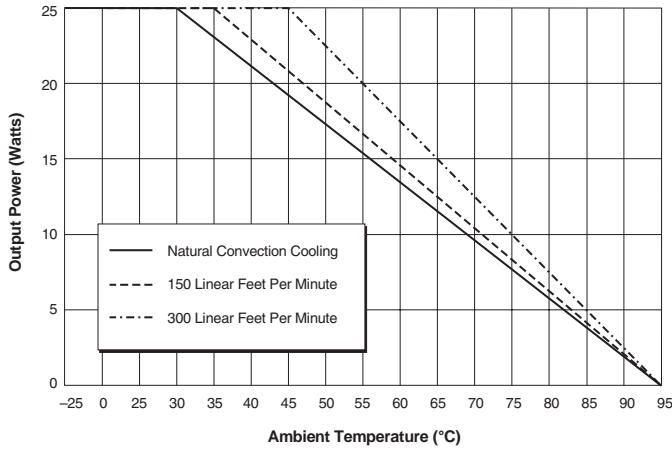
Certain applications and/or safety agencies may require the installation of fuses at the inputs of power conversion components. For DATEL TPB DC/DC Converters, you should use slow-blow type fuses with values no greater than the following:

V <sub>IN</sub> Range	Fuse Value
Q12	4A
D24	4A
Q48	3A
D48	2A

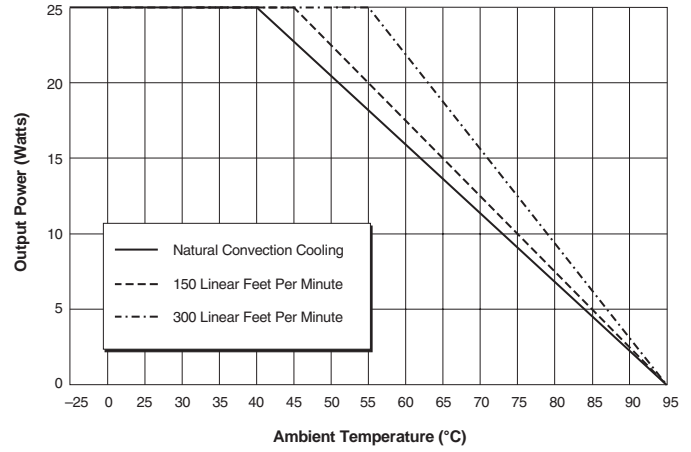
- ① These converters require a minimum 10% loading on their primary output and 20% loading on each auxiliary output to maintain specified regulation. Operation under no-load conditions will not damage these devices; however they may not meet all listed specifications.
- ② "Full load" varies by part number and is determined by the input voltage range as indicated by the part number suffix. See Technical Notes and Output Power Considerations.
- ③ Application-specific input/output filtering can be recommended or perhaps added internally upon request. Contact DATEL Applications Engineering for details.
- ④ Applying a voltage to the On/Off Control pin when no input power is applied to the converter can cause permanent damage to the converter. If desired, the On/Off Control function can be replaced with a Sync function. See page 6 of this data sheet for more details.

**Temperature Derating and Electrical Performance Curves**

**Q12 Models (25 Watts)**

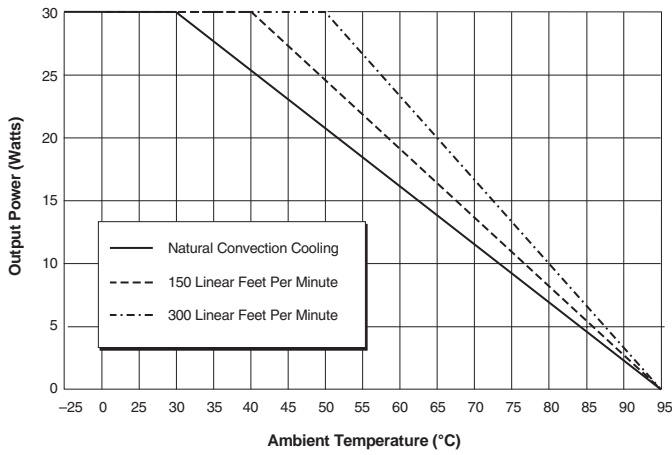


**Figure 2a. Temperature Derating Without Heat Sink**

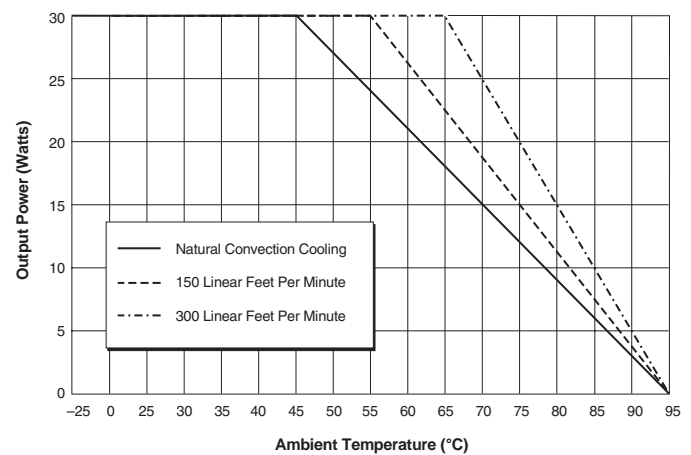


**Figure 2b. Temperature Derating With Heat Sink**

**Q48 Models (30 Watts)**

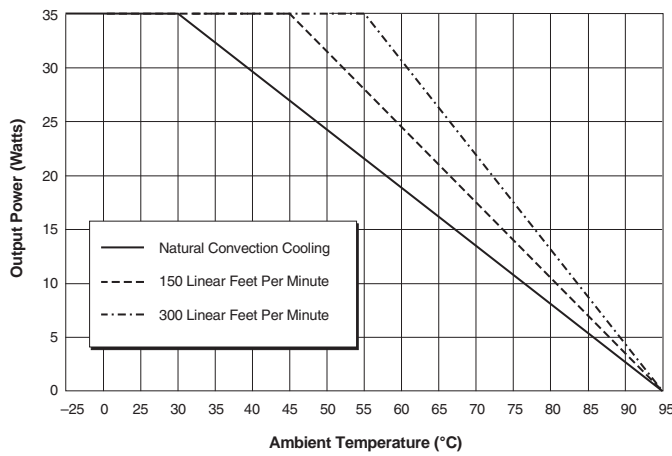


**Figure 3a. Temperature Derating Without Heat Sink**

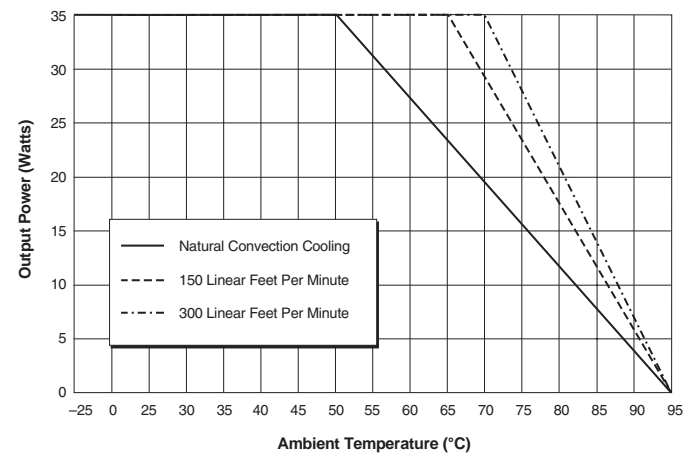


**Figure 3b. Temperature Derating With Heat Sink**

**D24 Models (35 Watts)**



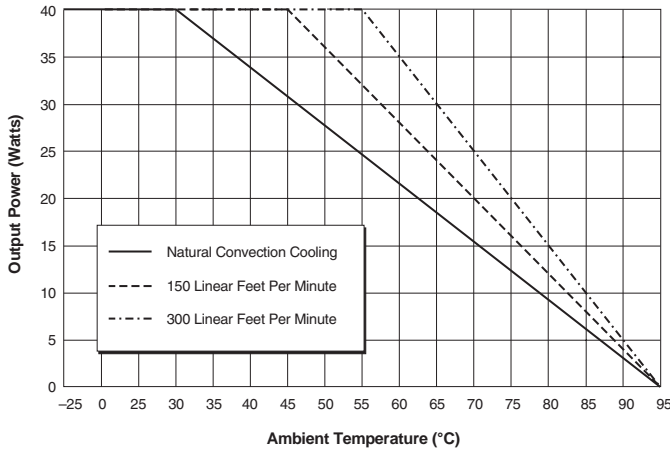
**Figure 4a. Temperature Derating Without Heat Sink**



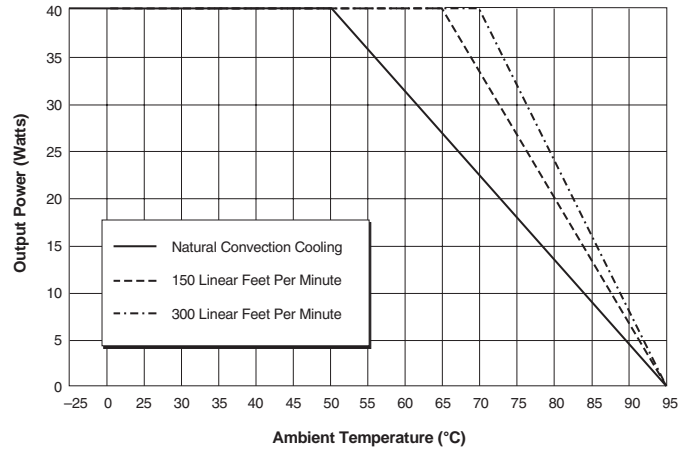
**Figure 4b. Temperature Derating With Heat Sink**

**Temperature Derating and Electrical Performance Curves**

**D48 Models (40 Watts)**



**Figure 5a. Temperature Derating Without Heat Sink**



**Figure 5b. Temperature Derating With Heat Sink**

**Output Power**

TPB Model, triple-output DC/DC converters incorporate a design tradeoff between total available output power and input voltage range. The total available power is a function of both the nominal input voltage and the "width" of the input voltage range. For a given nominal input (24V or 48V), narrower ranges (2:1 vs. 4:1) have more available power. For a given "width" of input range (2:1 or 4:1), higher nominal inputs (48V vs. 24V) have more available power. Each device, as indicated by its part-number suffix (Q12, Q48, D24, D48), has a total output power limitation of 25, 30, 35 or 40 Watts, respectively. Observing these power limitations is the user's responsibility.

As indicated by its Part Number Structure, each TPB device is capable of sourcing up to 5 Amps of +5V current as well as ±1 Amp of auxiliary (±12V

or ±15V) currents. Users have the flexibility of loading any output up to these limits; however, you must be extremely careful not to exceed the total output power rating of any given device. If, for example, a device with a 30W power rating is sourcing 4A from its +5V output (representing 20W of primary output power), that device can only supply an additional 10W from its auxiliary outputs (±333mA from ±15V outputs or ±417mA from ±12V outputs).

As a consequence of this "power-allocation" flexibility, the definition of "full load," as the condition under which performance specifications are tested and listed, is ambiguous. The following table lists the primary and auxiliary output currents that DATEL uses to define each device's "full load."

Model Number	Voltage Range	Output Power	Definition of "Full Load" for Specification Purposes		
			+5V Current	±12V Currents	±15V Currents
TPB-5/5-12/1-Q12	10-36V	25 Watts	2.6A (13W)	±500mA (12W)	–
TPB-5/5-12/1-Q48	18-72V	30 Watts	3A (15W)	±625mA (15W)	–
TPB-5/5-12/1-D24	18-36V	35 Watts	4A (20W)	±625mA (15W)	–
TPB-5/5-12/1-D48	36-72V	40 Watts	4A (20W)	±833mA (20W)	–
TPB-5/5-15/1-Q12	10-36V	25 Watts	2.5A (12.5W)	–	±417mA (12.5W)
TPB-5/5-15/1-Q48	18-72V	30 Watts	3A (15W)	–	±500mA (15W)
TPB-5/5-15/1-D24	18-36V	35 Watts	4A (20W)	–	±500mA (15W)
TPB-5/5-15/1-D48	36-72V	40 Watts	4A (20W)	–	±667mA (20W)

**Table 1. Output Currents Comprising "Full Load"**

**On/Off Control (Standard)**

The On/Off Control pin (pin 5) may be used for remote on/off operation. As shown in Figure 6, the control pin has an internal 10kΩ pull-up resistor to approximately 10V. The converter is designed so that it is enabled when the control pin is left open (normal mode) and disabled when the control pin is pulled low (to less than +0.8V relative to -Input, pin 2).

Dynamic control of the on/off function is best accomplished with a mechanical relay or an open-collector/open-drain drive circuit (optically isolated if appropriate). The drive circuit should obviously be able to sink approximately 1mA when activated and withstand more than 10 Volts when deactivated.

Applying an external voltage to pin 5 when no input power is applied to the converter can cause permanent damage to the converter. The on/off control function, however, is designed such that the converter can be disabled (pin 5 pulled low) while input power is ramping up and then "released" once the input has stabilized. Under these circumstances, it takes approximately 30ms for the output of the fully loaded DC/DC to ramp up and settle to within ±1% of its final value after the converter has been turned on.

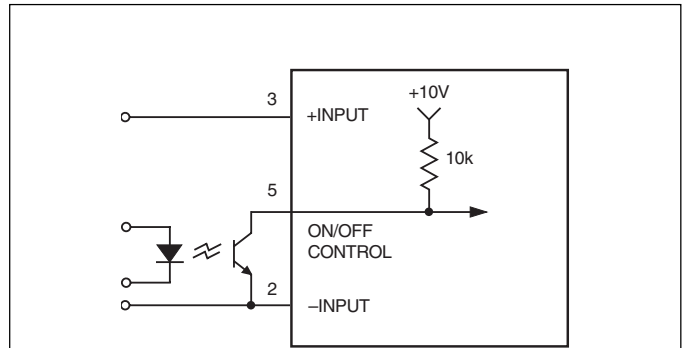
**Synchronization (Optional)**

In critical applications employing multiple switching DC/DC converters, it may be desirable to intentionally synchronize the switching of selected converters (so the system noise can be reduced with notch filtering) or to purposely desynchronize the converters (to lessen the current-carrying requirements on intermediate dc buses). TPB DC/DC Converters have been designed so that the On/Off Control function on pin 5 can be replaced with a Sync function. This change has to be implemented by DATEL during the product assembly process. Contact our Applications Engineering Group for additional details.

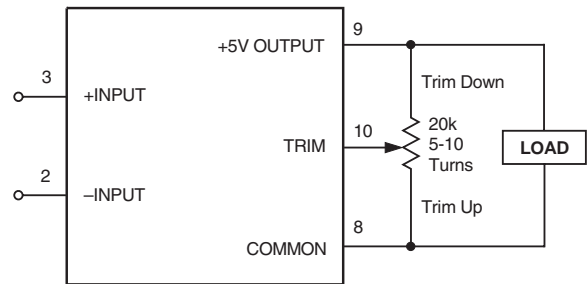
To synchronize the switching of multiple TPB converters configured with the Sync function, an external clock can be applied to pin 5 of each converter. The clock should be a TTL square wave referenced to -Input (logic high = +2 to +5 Volts, 250µA max.; logic low = 0 to +0.8 Volts, 70µA max.) with a maximum 1µsec "high" duration. The frequency of the synchronizing clock should be higher than that of any individual converter. Therefore, it should be 145kHz ±5kHz.

**Output Trimming**

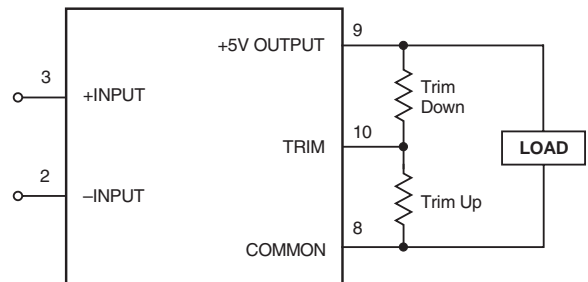
The +5V output may be trimmed ±5% via a single external trimpot or fixed resistor. The trimpot should be connected as shown in Figure 7 with its wiper connected to pin 10 (Trim). A trimpot can also be used to determine the value of a single fixed resistor which should be connected as shown in Figure 8. Connect the resistor between pin 10 (Trim) and pin 9 (+5V Output) to trim "down" the output voltage. Connect the resistor between pins 10 and 8 (Common) to trim "up" the output voltage. Fixed resistors should be metal-film types with absolute TCR's less than 100ppm/°C to ensure stability.



**Figure 6. Driving the On/Off Control Pin**



**Figure 7. Trim Connections Using a Trimpot**



**Figure 8. Trim Connections Using Fixed Resistors**

**Case Connection**

Unlike most other DC/DC converters, TPB DC/DC's do not have their metal case connected to one of their input pins. The "uncommitted" case is connected to pin 4 which, depending on your system configuration, should be connected to either +Input (pin 3) or -Input (pin 2).



ISO-9001 REGISTERED

DS-0408A 4/01

DATEL, Inc. 11 Cabot Boulevard, Mansfield, MA 02048-1151  
 Tel: (508) 339-3000 (800) 233-2765 Fax: (508) 339-6356  
 Internet: www.datel.com Email: sales@datel.com  
 Data Sheet Fax Back: (508) 261-2857

DATEL (UK) LTD. Tadley, England Tel: (01256)-880444  
 DATEL S.A.R.L. Montigny Le Bretonneux, France Tel: 01-34-60-01-01  
 DATEL GmbH München, Germany Tel: 89-544334-0  
 DATEL KK Tokyo, Japan Tel: 3-3779-1031, Osaka Tel: 6-6354-2025

DATEL makes no representation that the use of its products in the circuits described herein, or the use of other technical information contained herein, will not infringe upon existing or future patent rights. The descriptions contained herein do not imply the granting of licenses to make, use, or sell equipment constructed in accordance therewith. Specifications are subject to change without notice. The DATEL logo is a registered DATEL, Inc. trademark.