

TTL-INTERFACED, GATED DELAY LINE OSCILLATOR (SERIES DLO32F)

**data
delay
devices, inc.**



FEATURES

- Continuous or keyable wave train
- Synchronizes with arbitrary gating signal
- Fits standard 14-pin DIP socket
- Low profile
- Auto-insertable
- Input & outputs fully TTL interfaced & buffered
- Available in frequencies from 2MHz to 40MHz

PACKAGES

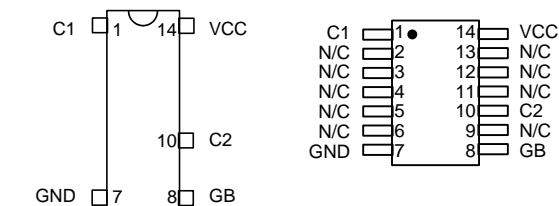

DLO32F-xx	DIP	Military SMD
DLO32F-xxA2	Gull-Wing	DLO32F-xxMD1
DLO32F-xxB2	J-Lead	DLO32F-xxMD4
DLO32F-xxM	Military DIP	

FUNCTIONAL DESCRIPTION

The DLO32F-series device is a gated delay line oscillator. The device produces a stable square wave which is synchronized with the falling edge of the Gate Input (GB). The frequency of oscillation is given by the device dash number (See Table). The two outputs (C1,C2) are in complementary during oscillation, but both return to logic low when the device is disabled.

PIN DESCRIPTIONS

GB	Gate Input
C1	Clock Output 1
C2	Clock Output 2
VCC	+5 Volts
GND	Ground

SERIES SPECIFICATIONS

- **Frequency accuracy:** 2%
- **Inherent delay (T_{EO}):** 3ns typical
- **Output skew:** 2.5ns typical
- **Output rise/fall time:** 2ns typical
- **Supply voltage:** 5VDC \pm 5%
- **Supply current:** 40ma typical (7ma when disabled)
- **Operating temperature:** 0° to 70° C
- **Temperature coefficient:** 100 PPM/°C (See text)

DASH NUMBER SPECIFICATIONS

Part Number	Frequency (MHz)
DLO32F-2	2.0 \pm 0.04
DLO32F-2.5	2.5 \pm 0.05
DLO32F-3	3.0 \pm 0.06
DLO32F-3.5	3.5 \pm 0.07
DLO32F-4	4.0 \pm 0.08
DLO32F-4.5	4.5 \pm 0.09
DLO32F-5	5.0 \pm 0.10
DLO32F-5.5	5.5 \pm 0.11
DLO32F-6	6.0 \pm 0.12
DLO32F-7	7.0 \pm 0.14
DLO32F-8	8.0 \pm 0.16
DLO32F-9	9.0 \pm 0.18
DLO32F-10	10 \pm 0.20
DLO32F-12	12 \pm 0.24
DLO32F-14	14 \pm 0.28
DLO32F-15	15 \pm 0.30
DLO32F-20	20 \pm 0.40
DLO32F-25	25 \pm 0.50
DLO32F-30	30 \pm 0.60
DLO32F-35	35 \pm 0.70
DLO32F-40	40 \pm 0.80

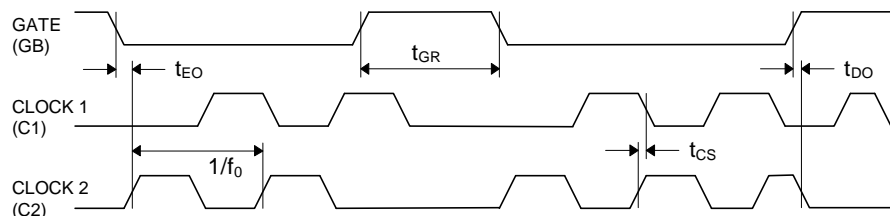

Figure 1: Timing Diagram

NOTE: Any dash number between 2 and 40 not shown is also available.

APPLICATION NOTES

THERMAL STABILITY

The delay line used internally to develop the clock signals in the DLO32F has a thermal coefficient of 100ppm/C. For low frequency units, this is also the thermal coefficient of the output frequency. For higher frequency units, however, other internal effects must be considered, and the actual thermal coefficient may be somewhat higher.

POWER SUPPLY BYPASSING

The DLO32F relies on a stable power supply to produce a repeatable frequency within the stated tolerances. A 0.1uf capacitor from VCC to GND, located as close as possible to the VCC pin, is recommended. A wide VCC trace and a clean ground plane should be used.

DEVICE SPECIFICATIONS

TABLE 1: ABSOLUTE MAXIMUM RATINGS

PARAMETER	SYMBOL	MIN	MAX	UNITS	NOTES
DC Supply Voltage	V _{CC}	-0.3	7.0	V	
Input Pin Voltage	V _{IN}	-0.3	V _{DD} +0.3	V	
Storage Temperature	T _{STRG}	-55	150	C	
Lead Temperature	T _{LEAD}		300	C	10 sec

TABLE 2: DC ELECTRICAL CHARACTERISTICS

(0C to 70C, 4.75V to 5.25V)

PARAMETER	SYMBOL	MIN	TYP	MAX	UNITS	NOTES
High Level Output Voltage	V _{OH}	2.5	3.4		V	V _{CC} = MIN, I _{OH} = MAX V _{IH} = MIN, V _{IL} = MAX
Low Level Output Voltage	V _{OL}		0.35	0.5	V	V _{CC} = MIN, I _{OL} = MAX V _{IH} = MIN, V _{IL} = MAX
High Level Output Current	I _{OH}			-1.0	mA	
Low Level Output Current	I _{OL}			20.0	mA	
High Level Input Voltage	V _{IH}	2.0			V	
Low Level Input Voltage	V _{IL}			0.8	V	
Input Clamp Voltage	V _{IK}			-1.2	V	V _{CC} = MIN, I _I = I _{IK}
Input Current at Maximum Input Voltage	I _{IHH}			0.1	mA	V _{CC} = MAX, V _I = 7.0V
High Level Input Current	I _{IH}			20	μA	V _{CC} = MAX, V _I = 2.7V
Low Level Input Current	I _{IL}			-0.6	mA	V _{CC} = MAX, V _I = 0.5V
Short-circuit Output Current	I _{OS}	-60		-150	mA	V _{CC} = MAX
Output High Fan-out				25	Unit	
Output Low Fan-out				12.5	Load	

TABLE 3: AC ELECTRICAL CHARACTERISTICS

(0C to 70C, 4.75V to 5.25V)

PARAMETER	SYMBOL	MIN	TYP	MAX	UNITS
Enable to Clock On (Inherent Delay)	t _{EO}	1.5	3.0	4.5	ns
Disable to Clock Off	t _{DO}	1.5	2.5	3.5	ns
Clock Skew	t _{CS}	1.5	2.5	3.5	ns
Gate Recovery Time	t _{GR}	50			% of Clock Period

PACKAGE DIMENSIONS

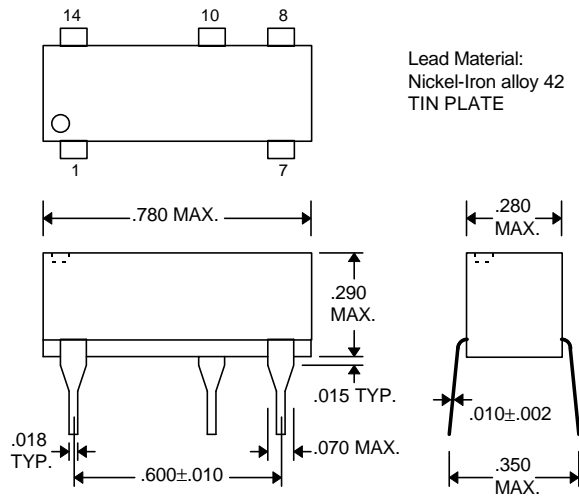

DLO32F-xx (Commercial DIP)

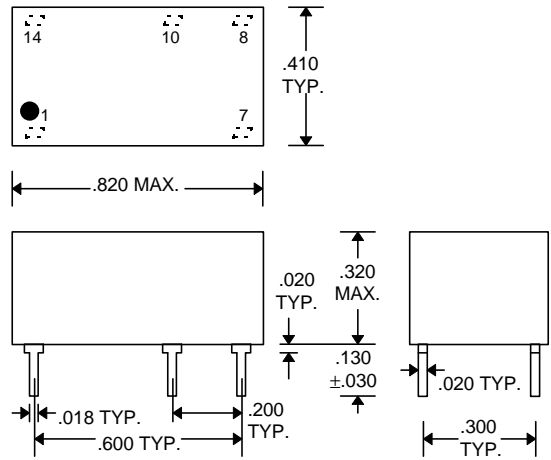

DLO32F-xxM (Military DIP)

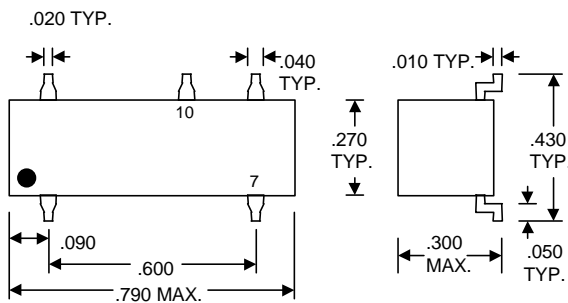

DLO32F-xxA2 (Commercial Gull-Wing)

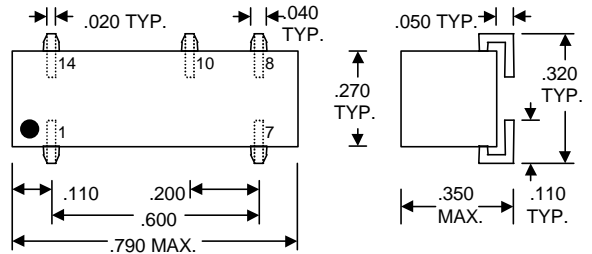

DLO32F-xxB2 (Commercial J-Lead)

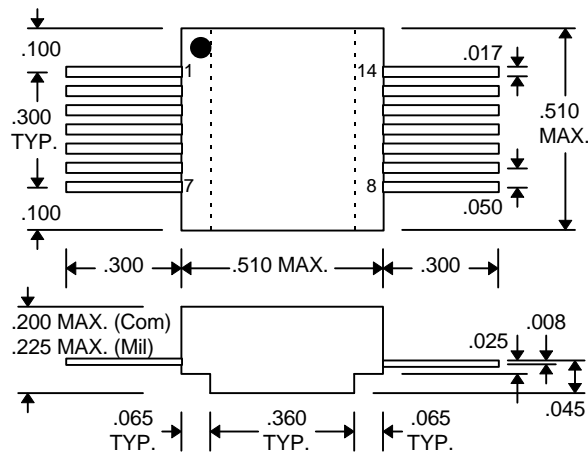

DLO32F-xxD1 (Commercial SMD)
DLO32F-xxMD1 (Military SMD)

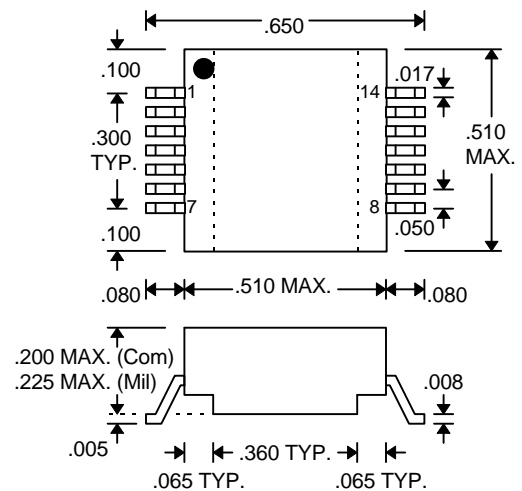

DLO32F-xxD4 (Commercial SMD)
DLO32F-xxMD4 (Military SMD)

DELAY LINE AUTOMATED TESTING

TEST CONDITIONS

INPUT:

Ambient Temperature: $25^{\circ}\text{C} \pm 3^{\circ}\text{C}$
Supply Voltage (Vcc): $5.0\text{V} \pm 0.1\text{V}$
Input Pulse: High = $3.0\text{V} \pm 0.1\text{V}$
 Low = $0.0\text{V} \pm 0.1\text{V}$
Source Impedance: 50Ω Max.
Rise/Fall Time: 3.0 ns Max. (measured between 0.6V and 2.4V)
Pulse Width Low: $\text{PW}_{\text{IN}} = 10 \times \text{Clock Period}$
Period: $\text{PER}_{\text{IN}} = 20 \times \text{Clock Period}$

OUTPUT:

Load: 1 FAST-TTL Gate
C_{load}: $5\text{pf} \pm 10\%$
Threshold: 1.5V (Rising & Falling)

NOTE: The above conditions are for test only and do not in any way restrict the operation of the device.

