

Digital PC to TV Encoder

Features

- Pin and function compatible with CH7003
- Universal digital interface accepts YCrCb (CCIR601 or 656) or RGB (15, 16 or 24-bit) video data in both non-interlaced and interlaced formats
- True Scale™ rendering engine supports undescan operations for various graphics resolutions † ‡
- Enhanced text sharpness and adaptive flicker removal with up to 5-lines of filtering †
- Enhanced dot crawl control and area reduction
- Fully programmable through serial port
- Supports NTSC, NTSC-EIA (Japan), and PAL (B, D, G, H, I, M and N) TV formats
- Provides Composite, S-Video and SCART outputs
- Auto-detection of TV presence
- Supports VBI pass-through
- Programmable power management
- 9-bit video DAC outputs
- Complete Windows and DOS driver software
- Offered in 44-pin PLCC, 44-pin TQFP

General Description

Chrontel's CH7013A digital PC to TV encoder is a stand-alone integrated circuit which provides a PC 99 compliant solution for TV output. It provides a universal digital input port to accept a pixel data stream from a compatible VGA controller (or equivalent) and converts this directly into NTSC or PAL TV format.

This circuit integrates a digital NTSC/PAL encoder with 9-bit DAC interface, and new adaptive flicker filter, and high accuracy low-jitter phase locked loop to create outstanding quality video. Through its TrueScale™ scaling and deflickering engine, the CH7013A supports full vertical and horizontal undescan capability and operates in 5 different resolutions including 640x480 and 800x600.

A new universal digital interface along with full programmability make the CH7013A ideal for system-level PC solutions. All features are software programmable through a serial port, to enable a complete PC solution using a TV as the primary display.

† Patent number 5,781,241

‡ Patent number 5,914,753

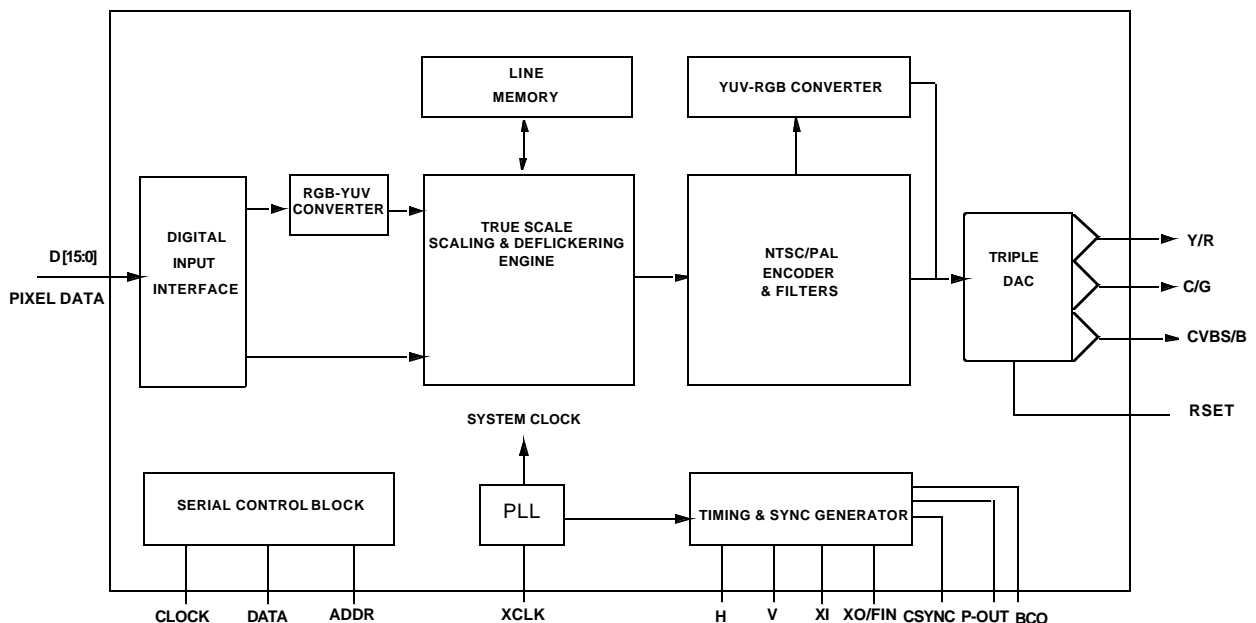

Figure 1: Functional Block Diagram

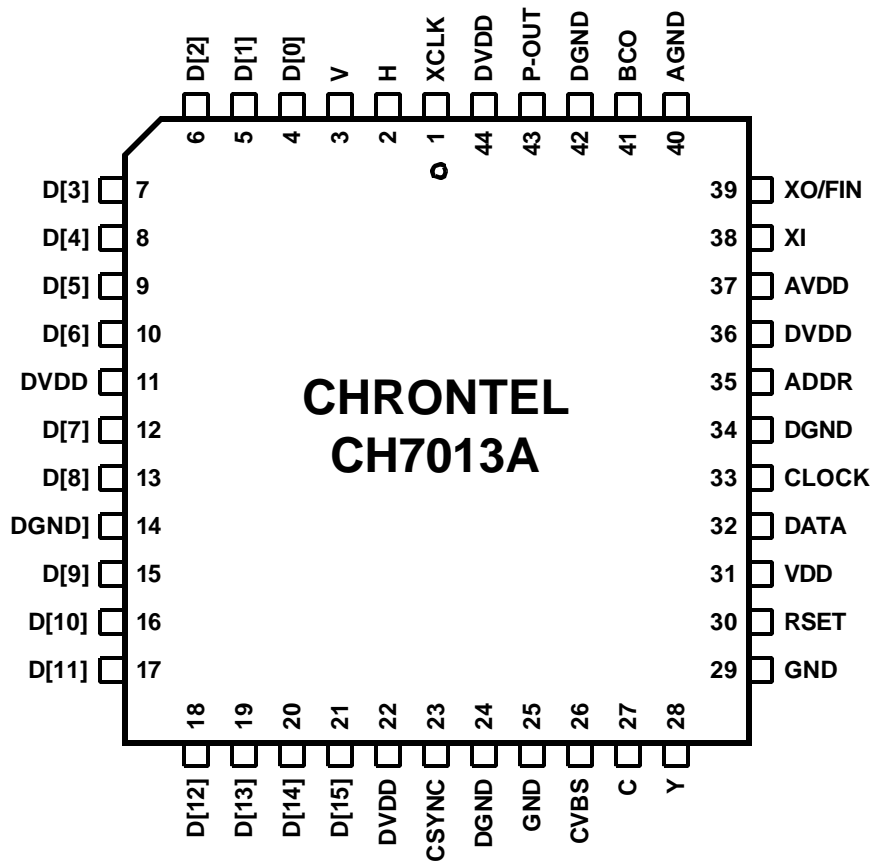

Figure 2: 44-Pin PLCC

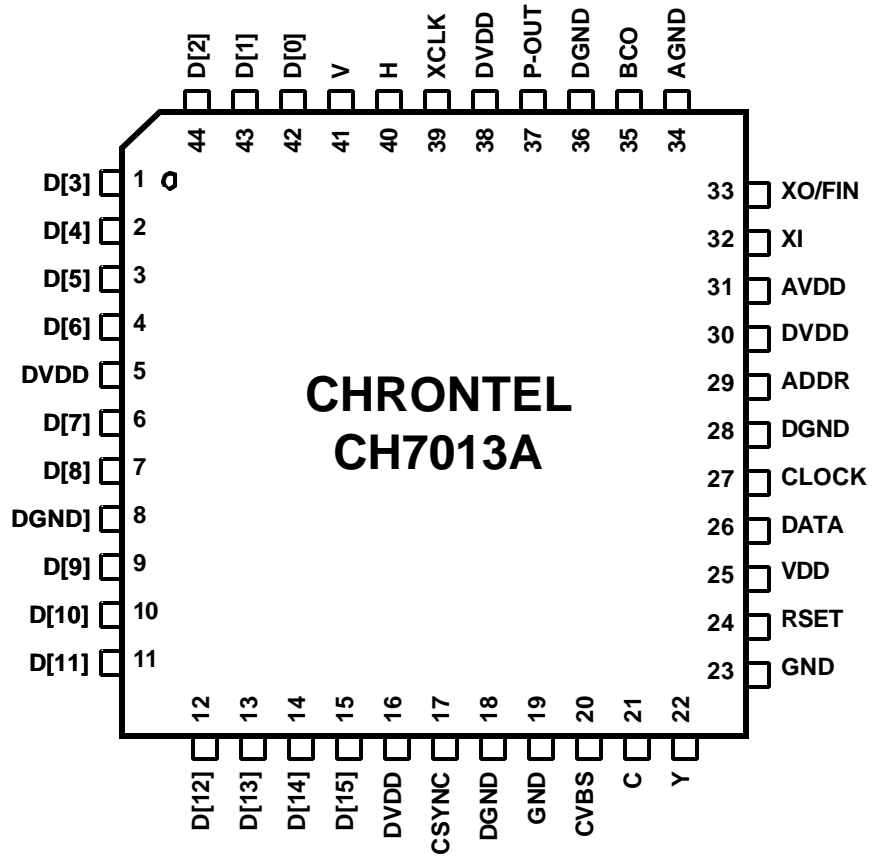

Figure 3: 44-PIN TQFP

Table 1. Pin Descriptions

44-Pin PLCC	44Pin TQFP	Type	Symbol	Description
21-15 13-12, 10-4	15,14, 13,12, 11,10, 9,7,6, 4,3, 2,1, 44,43,42	In	D15-D0	Digital Pixel Inputs These pins accept digital pixel data streams with either 8, 12, or 16-bit multiplexed or 16-bit non-multiplexed formats, determined by the input mode setting (see <i>Registers and Programming</i> section). Inputs D0 - D7 are used when operating in 8-bit multiplexed mode. Inputs D0 - D11 are used when operating in 12-bit mode. Inputs D0 - D15 are used when operating in 16-bit mode. The data structure and timing sequence for each mode is described in the section on Digital Input Port.
43	37	Out	P-OUT	Pixel Clock Output The CH7013A, operating in master mode, provides a pixel data clocking signal to the VGA controller. This pin provides the pixel clock output signal (adjustable as X, 2X or 3X) to the VGA controller (see the section on <i>Digital Video Interface and Registers and Programming</i> for more details). The capacitive loading on this pin should be kept to a minimum.
1	39	In	XCLK	Pixel Clock Input To operate in a pure master mode, the P-OUT signal should be connected to the XCLK input pin. To operate in a pseudo-master mode, the P-OUT clock is used as a reference frequency, and a signal locked to this output (at 1X, 1/2X, or 1/3X the P-OUT frequency) is input to the XCLK pin. To operate in slave mode, the CH7013A accepts an external pixel clock input at this pin. The capacitive loading on this pin should be kept to a minimum.
3	41	In/Out	V	Vertical Sync Input/Output This pin accepts the vertical sync signal from the VGA controller, or outputs a vertical sync to the VGA controller. The capacitive loading on this pin should be kept to a minimum.
2	40	In/Out	H	Horizontal Sync Input/Output This pin accepts the horizontal sync from the VGA controller, or outputs a horizontal sync to the VGA controller. The capacitive loading on this pin should be kept to a minimum.
41	35	Out	BCO	Buffered Clock Output This pin provides a buffered output of the 14.31818 MHz crystal input frequency for other devices and remains active at all times (including power-down). The output can also be selected to be other frequencies (see <i>Registers and Programming</i>).
38	32	In	XI	Crystal Input A parallel resonance 14.31818 MHz (± 50 ppm) crystal should be attached between XI and XO/FIN. However, if an external CMOS clock is attached to XO/FIN, XI should be connected to ground.
39	33	In	XO/FIN	Crystal Output or External Fref A 14.31818 MHz (± 50 ppm) crystal may be attached between XO/FIN and XI. An external CMOS compatible clock can be connected to XO/FIN as an alternative.

Table 1. Pin Descriptions

44-Pin PLCC	44Pin TQFP	Type	Symbol	Description						
30	24	In	RSET	Reference Resistor A 360 Ω resistor with short and wide traces should be attached between RSET and ground. No other connections should be made to this pin.						
28	22	Out	Y/R	Luminance Output A 75 Ω termination resistor with short traces should be attached between Y and ground for optimum performance. In normal operating modes other than SCART, this pin outputs the luma video signal. In SCART mode, this pin outputs the red signal.						
27	21	Out	C/G	Chrominance Output A 75 Ω termination resistor with short traces should be attached between C and ground for optimum performance. In normal operating modes other than SCART, this pin outputs the chroma video signal. In SCART mode, this pin outputs the green signal.						
26	20	Out	CVBS/B	Composite Video Output A 75 Ω termination resistor with short traces should be attached between CVBS and ground for optimum performance. In normal operating modes other than SCART, this pin outputs the composite video signal. In SCART mode, this pin outputs the blue signal.						
23	17	Out	CSYNC	Composite Sync Output A 75 Ω termination resistor with short traces should be attached between CSYNC and ground for optimum performance. In SCART mode, this pin outputs the composite sync signal.						
32	26	In/Out	DATA	Serial Data (External pull-up required) This pin functions as the serial data pin of the serial interface port (see the <i>serial Port Operation</i> section for details).						
33	27	In	CLOCK	Serial Clock (Internal pull-up) This pin functions as the serial clock pin of the serial interface port (see the <i>serial Port Operation</i> section for details).						
35	29	In	ADDR	Serial Address Select (Internal pull-up) This pin is the serial Address Select, which corresponds to bits 1 and 0 of the serial device address (see the <i>serial Port Operation</i> section for details), creating an address selection as follows: <table style="margin-left: 40px; border: none;"> <tr> <td>ADDR</td> <td>Serial Address Selected</td> </tr> <tr> <td>1</td> <td>1110101 = 75H = 117</td> </tr> <tr> <td>0</td> <td>1110110 = 76H = 118</td> </tr> </table>	ADDR	Serial Address Selected	1	1110101 = 75H = 117	0	1110110 = 76H = 118
ADDR	Serial Address Selected									
1	1110101 = 75H = 117									
0	1110110 = 76H = 118									
40	34	Power	AGND	Analog ground These pins provide the ground reference for the analog section of the CH7013A, and MUST be connected to the system ground, to prevent latchup. Refer to the <i>Application Information</i> section for information on proper supply de-coupling.						
37	31	Power	AVDD	Analog Supply Voltage These pins supply the 5V power to the analog section of the CH7013A.						

Table 1. Pin Descriptions

44-Pin PLCC	44Pin TQFP	Type	Symbol	Description
31	25	Power	VDD	DAC Power Supply These pins supply the 5V power to CH7013A's internal DAC's.
29, 25	19,23	Power	GND	DAC Ground These pins provide the ground reference for CH7013A's internal DACs. For information on proper supply de-coupling, please refer to the Application Information section.
44, 36, 22, 11	5,16, 30,38	Power	DVDD	Digital Supply Voltage These pins supply the 3.3V power to the digital section of CH7013A.
42, 34, 24, 14	8,18, 28,36	Power	DGND	Digital Ground These pins provide the ground reference for the digital section of CH7013A, and MUST be connected to the system ground to prevent latchup.

Digital Video Interface

The CH7013A digital video interface provides a flexible digital interface between a computer graphics controller and the TV encoder IC, forming the ideal quality/cost configuration for performing the TV-output function. This digital interface consists of up to 16 data signals and 4 control signals, all of which are subject to programmable control through the CH7013A register set. This interface can be configured as 8, 12 or 16-bit inputs operating in either multiplexed mode or 16-bit input operation in de-multiplexed mode. It will also accept either YCrCb or RGB (15, 16 or 24-bit) data formats and will accept both non-interlaced and interlaced data formats. A summary of the input data format modes is as follows:

Table 2. Input Data Formats

Bus Width	Transfer Mode	Color Space and Depth	Format Reference
16-bit	Non-multiplexed	RGB 16-bit	5-6-5 each word
15-bit	Non-multiplexed	RGB 15-bit	5-5-5 each word
16-bit	Non-multiplexed	YCrCb (24-bit)	CbY0,CrY1...(CCIR656 style)
8-bit	2X-multiplexed	RGB 15-bit	5-5-5 over two bytes
8-bit	2X-multiplexed	RGB 16-bit	5-6-5 over two bytes
8-bit	3X-multiplexed	RGB 24-bit	8-8-8 over three bytes
8-bit	2X-multiplexed	YCrCb (24-bit)	Cb,Y0,Cr,Y1,(CCIR656 style)
12-bit	2X-multiplexed	RGB 24	8-8-8 over two words - 'C' version
12-bit	2X-multiplexed	RGB 24	8-8-8 over two words - 'I' version
16-bit	2X-multiplexed	RGB 24 (32)	8-8,8X over two words

The clock and timing signals used to latch and process the incoming pixel data is dependent upon the clock mode. The CH7013A can operate in either master (the CH7013A generates a pixel frequency which is either returned as a phase-aligned pixel clock or used directly to latch data), or slave mode (the graphics chip generates the pixel clock). The pixel clock frequency will change depending upon the active image size (e.g., 640x480 or 800x600), the desired output format (NTSC or PAL), and the amount of scaling desired. The pixel clock may be requested to be 1X, 2X, or 3X the pixel data rate (subject to a 100MHz frequency limitation). In the case of a 1X pixel clock the CH7013A will automatically use both clock edges, if a multiplexed data format is selected.

Sync Signals: Horizontal and vertical sync signals will normally be supplied by the VGA controller, but may be selected to be generated by the CH7013A. In the case of CCIR656 style input (IDF = 1 or 9), embedded sync may also be used. (In each case, the period of the horizontal sync should be equal to the duration of the pixel clock, times the first value of the (Total Pixels/Line x Total Lines/Frame) column of the **Table 17** on page 32 (display Mode Register OOH description). The leading edge of the horizontal sync is used to determine the start of each line. The Vertical sync signal must be able to be set to the second value in the: (Total Pixels/Line x Total Lines/Frame) column of **Table 17** on page 32).

Master Clock Mode: The CH7013A generates a clock signal (output at the P-OUT pin) which will be used by the VGA controller as a frequency reference. The VGA controller will then generate a clock signal which will be input via the XCLK input. This incoming signal will be used to latch (and de-multiplex, if required) incoming data. The XCLK input clock rate must match the input data rate, and the P-OUT clock can be requested to be 1X, 2X or 3X the pixel data rate. As an alternative, the P-OUT clock signal can also be used as the input clock signal (connected directly to the XCLK input) to latch the incoming data. If this mode is used, the incoming data must meet setup and hold times with respect to the XCLK input (with the only internal adjustment being XCLK polarity).

Slave Clock Mode: The VGA controller will generate a clock which will be input to the XCLK pin (no clock signal will be output on the P-OUT pin). This signal must match the input data rate, must occur at 1X, 2X or 3X the pixel data rate, and will be used to latch (and de-multiplex if required) incoming data. Also, the graphics IC transmits back to the TV encoder the horizontal and vertical timing signals, and pixel data, each of which must meet the specified setup and hold times with respect to the pixel clock.

Pixel Data: Active pixel data will be expected after a programmable number of pixels times the multiplex rate after the leading edge of Horizontal Sync. In other words, specifying the horizontal back porch value (as a pixel count), plus horizontal sync width, will determine when the chip will begin to sample pixels.

Non-multiplexed Mode

In the 15/16-bit mode shown in **Figure 4** the pixel data bus represents a 15/16-bit non-multiplexed data stream, which contains either RGB or YCrCb formatted data. When operating in RGB mode, each 15/16-bit Pn value will contain a complete pixel encoded in either 5-6-5 or 5-5-5 format. When operating in YCrCb mode, each 16-bit Pn word will contain an 8-bit Y (luminance) value on the upper 8 bits, and an 8-bit C (color difference) value on the lower 8 bits. The color difference will be transmitted at half the data rate of the luminance data, with the sequence-being set as Cb followed by Cr. The Cb and Cr data will be co-sited with the Y value transmitted with the Cb value, with the data sequence described in **Table 3**. The first active pixel is SAV pixels after the trailing edge of horizontal sync, where SAV is a bus-controlled register.

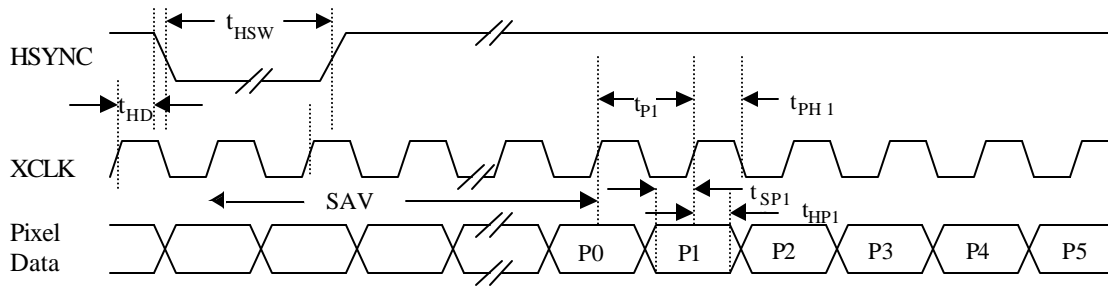

Figure 4: Non-multiplexed Data Transfers

Table 3. 15/16-bit Non-multiplexed Data Formats

IDF# Format		0 RGB 5-6-5		3 RGB 5-5-5		1 YCrCb (16-bit)			
Pixel#		P0	P1	P0	P1	P0	P1	P2	P3
Bus Data	D[15]	R0[4]	R1[4]	x	x	Y0[7]	Y1[7]	Y2[7]	Y3[7]
	D[14]	R0[3]	R1[3]	R2[4]	R3[4]	Y0[6]	Y1[6]	Y2[6]	Y3[6]
	D[13]	R0[2]	R1[2]	R2[3]	R3[3]	Y0[5]	Y1[5]	Y2[5]	Y3[5]
	D[12]	R0[1]	R1[1]	R2[2]	R3[2]	Y0[4]	Y1[4]	Y2[4]	Y3[4]
	D[11]	R0[0]	R1[0]	R2[1]	R3[1]	Y0[3]	Y1[3]	Y2[3]	Y3[3]
	D[10]	G0[5]	G1[5]	R2[0]	R3[0]	Y0[2]	Y1[2]	Y2[2]	Y3[2]
	D[9]	G0[4]	G1[4]	G2[4]	G3[4]	Y0[1]	Y1[1]	Y2[1]	Y3[1]
	D[8]	G0[3]	G1[3]	G2[3]	G3[3]	Y0[0]	Y1[0]	Y2[0]	Y3[0]
	D[7]	G0[2]	G1[2]	G2[2]	G3[2]	Cb0[7]	Cr0[7]	Cb2[7]	Cr2[7]
	D[6]	G0[1]	G1[1]	G2[1]	G3[1]	Cb0[6]	Cr0[6]	Cb2[6]	Cr2[6]
	D[5]	G0[0]	G1[0]	G2[0]	G3[0]	Cb0[5]	Cr0[5]	Cb2[5]	Cr2[5]
	D[4]	B0[4]	B1[4]	B2[4]	B3[4]	Cb0[4]	Cr0[4]	Cb2[4]	Cr2[4]
	D[3]	B0[3]	B1[3]	B2[3]	B3[3]	Cb0[3]	Cr0[3]	Cb2[3]	Cr2[3]
	D[2]	B0[2]	B1[2]	B2[2]	B3[2]	Cb0[2]	Cr0[2]	Cb2[2]	Cr2[2]
	D[1]	B0[1]	B1[1]	B2[1]	B3[1]	Cb0[1]	Cr0[1]	Cb2[1]	Cr2[1]
	D[0]	B0[0]	B1[0]	B2[0]	B3[0]	Cb0[0]	Cr0[0]	Cb2[0]	Cr2[0]

Digital Video Interface (continued)

When IDF = 1, (YCrCb 16-bit mode), H and V sync signals can be embedded into the data stream. In this mode, the embedded sync will be similar to the CCIR656 convention (not identical, since that convention is for 8-bit data streams), and the first byte of the ‘video timing reference code’ will be assumed to occur when a Cb sample would occur – if the video stream was continuous. This is delineated in **Table 4** below.

Table 4. YCrCb Non-multiplexed Mode with Embedded Syncs

IDF# Format		1 YCrCb 16-bit							
Pixel#		P0	P1	P2	P3	P4	P5	P6	P7
Bus Data	D[15]	0	S[7]	Y0[7]	Y1[7]	Y2[7]	Y3[7]	Y4[7]	Y5[7]
	D[14]	0	S[6]	Y0[6]	Y1[6]	Y2[6]	Y3[6]	Y4[6]	Y5[6]
	D[13]	0	S[5]	Y0[5]	Y1[5]	Y2[5]	Y3[5]	Y4[5]	Y5[5]
	D[12]	0	S[4]	Y0[4]	Y1[4]	Y2[4]	Y3[4]	Y4[4]	Y5[4]
	D[11]	0	S[3]	Y0[3]	Y1[3]	Y2[3]	Y3[3]	Y4[3]	Y5[3]
	D[10]	0	S[2]	Y0[2]	Y1[2]	Y2[2]	Y3[2]	Y4[2]	Y5[2]
	D[9]	0	S[1]	Y0[1]	Y1[1]	Y2[1]	Y3[1]	Y4[1]	Y5[1]
	D[8]	0	S[0]	Y0[0]	Y1[0]	Y2[0]	Y3[0]	Y4[0]	Y5[0]
	D[7]	1	0	Cb0[7]	Cr0[7]	Cb2[7]	Cr2[7]	Cb4[7]	Cr4[7]
	D[6]	1	0	Cb0[6]	Cr0[6]	Cb2[6]	Cr2[6]	Cb4[6]	Cr4[6]
	D[5]	1	0	Cb0[5]	Cr0[5]	Cb2[5]	Cr2[5]	Cb4[5]	Cr4[5]
	D[4]	1	0	Cb0[4]	Cr0[4]	Cb2[4]	Cr2[4]	Cb4[4]	Cr4[4]
	D[3]	1	0	Cb0[3]	Cr0[3]	Cb2[3]	Cr2[3]	Cb4[3]	Cr4[3]
	D[2]	1	0	Cb0[2]	Cr0[2]	Cb2[2]	Cr2[2]	Cb4[2]	Cr4[2]
	D[1]	1	0	Cb0[1]	Cr0[1]	Cb2[1]	Cr2[1]	Cb4[1]	Cr4[1]
	D[0]	1	0	Cb0[0]	Cr0[0]	Cb2[0]	Cr2[0]	Cb4[0]	Cr4[0]

In this mode, the S[7-0] byte contains the following data:

- S[6] = F = 1 during field 2, 0 during field 1
- S[5] = V = 1 during field blanking, 0 elsewhere
- S[4] = H = 1 during EAV (the synchronization reference at the end of active video)
0 during SAV (the synchronization reference at the start of active video)

Bits S[7] and S[3..0] are ignored.

Multiplexed Mode

Each rising edge (or each rising and falling edge) of the XCLK signal will latch data from the graphics chip. The multiplexed input data formats are shown in **Figures 5** and **6**. The Pixel Data bus represents an 8, 12, or 16-bit multiplexed data stream, which contains either RGB or YCrCb formatted data. In IDF settings of 2, 4, 5, 7, 8, and 9, the input data rate is 2X PCLK, and each pair of Pn values (e.g., P0a and P0b) will contain a complete pixel, encoded as shown in the tables below. When IDF = 6, the input data rate is 3X PCLK, and each triplet of Pn values (e.g., P0a, P0b and P0c) will contain a complete pixel, encoded as shown in the tables below. When the input is YCrCb, the color-difference data will be transmitted at half the data rate of the luminance data, with the sequence being set as Cb, Y, Cr, Y where Cb0,Y0,Cr0 refers to co-sited luminance and color-difference samples — and the following Y1 byte refers to the next luminance sample, per CCIR656 standards. However, the clock frequency is dependent upon the current mode, (not 27MHz, as specified in CCIR656).

Digital Video Interface (continued)

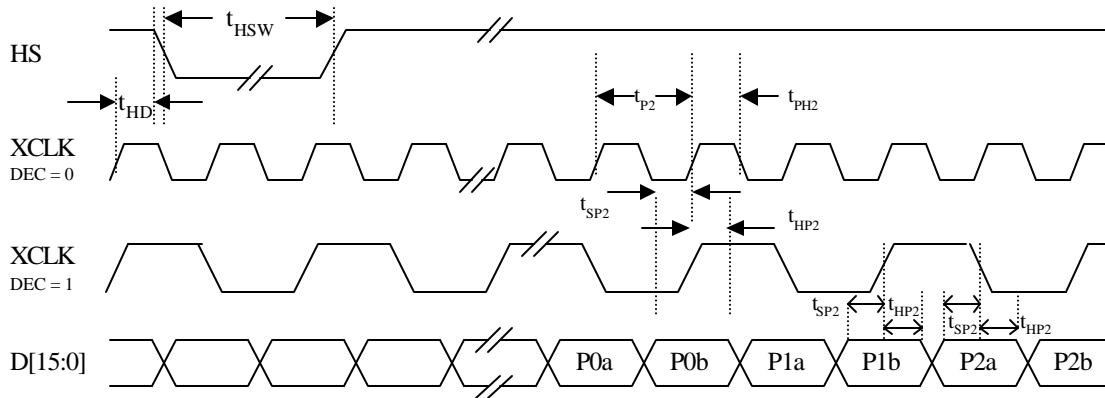

Figure 5: Multiplexed Pixel Data Transfer Mode

Table 5. RGB 8-bit Multiplexed Mode

IDF# Format		7 RGB 5-6-5				8 RGB 5-5-5			
Pixel#		P0a	P0b	P1a	P1b	P0a	P0b	P1a	P1b
Bus Data	D[7]	G0[2]	R0[4]	G1[2]	R1[4]	G0[2]	x	G1[2]	x
	D[6]	G0[1]	R0[3]	G1[1]	R1[3]	G0[1]	R0[4]	G1[1]	R1[4]
	D[5]	G0[0]	R0[2]	G1[0]	R1[2]	G0[0]	R0[3]	G1[0]	R1[3]
	D[4]	B0[4]	R0[1]	B1[4]	R1[1]	B0[4]	R0[2]	B1[4]	R1[2]
	D[3]	B0[3]	R0[0]	B1[3]	R1[0]	B0[3]	R0[1]	B1[3]	R1[1]
	D[2]	B0[2]	G0[5]	B1[2]	G1[5]	B0[2]	R0[0]	B1[2]	R1[0]
	D[1]	B0[1]	G0[4]	B1[1]	G1[4]	B0[1]	G0[4]	B1[1]	G1[4]
	D[0]	B0[0]	G0[3]	B1[0]	G1[3]	B0[0]	G0[3]	B1[0]	G1[3]

Table 6. RGB 12-bit Multiplexed Mode

IDF# Format		4 12-bit RGB (12-12)				5 12-bit RGB (12-12)			
Pixel#		P0a	P0b	P1a	P1b	P0a	P0b	P1a	P1b
Bus Data	D[11]	G0[3]	R0[7]	G1[3]	R1[7]	G0[4]	R0[7]	G1[4]	R1[7]
	D[10]	G0[2]	R0[6]	G1[2]	R1[6]	G0[3]	R0[6]	G1[3]	R1[6]
	D[9]	G0[1]	R0[5]	G1[1]	R1[5]	G0[2]	R0[5]	G1[2]	R1[5]
	D[8]	G0[0]	R0[4]	G1[0]	R1[4]	B0[7]	R0[4]	B1[7]	R1[4]
	D[7]	B0[7]	R0[3]	B1[7]	R1[3]	B0[6]	R0[3]	B1[6]	R1[3]
	D[6]	B0[6]	R0[2]	B1[6]	R1[2]	B0[5]	G0[7]	B1[5]	G1[7]
	D[5]	B0[5]	R0[1]	B1[5]	R1[1]	B0[4]	G0[6]	B1[4]	G1[6]
	D[4]	B0[4]	R0[0]	B1[4]	R1[0]	B0[3]	G0[5]	B1[3]	G1[5]
	D[3]	B0[3]	G0[7]	B1[3]	G1[7]	G0[0]	R0[2]	G1[0]	R1[2]
	D[2]	B0[2]	G0[6]	B1[2]	G1[6]	B0[2]	R0[1]	B1[2]	R1[1]
	D[1]	B0[1]	G0[5]	B1[1]	G1[5]	B0[1]	R0[0]	B1[1]	R1[0]
	D[0]	B0[0]	G0[4]	B1[0]	G1[4]	B0[0]	G0[1]	B1[0]	G1[1]

Digital Video Interface (continued)

Table 7. RGB 16-bit Muxed Mode

IDF# Format		2 16-bit RGB (16-8)			
Pixel#		P0a	P0b	P1a	P1b
Bus Data	D[15]	G0[7]	A0[7]	G1[7]	A1[7]
	D[14]	G0[6]	A0[6]	G1[6]	A1[6]
	D[13]	G0[5]	A0[5]	G1[5]	A1[5]
	D[12]	G0[4]	A0[4]	G1[4]	A1[4]
	D[11]	G0[3]	A0[3]	G1[3]	A1[3]
	D[10]	G0[2]	A0[2]	G1[2]	A1[2]
	D[9]	G0[1]	A0[1]	G1[1]	A1[1]
	D[8]	G0[0]	A0[0]	G1[0]	A1[0]
	D[7]	B0[7]	R0[7]	B1[7]	R1[7]
	D[6]	B0[6]	R0[6]	B1[6]	R1[6]
	D[5]	B0[5]	R0[5]	B1[5]	R1[5]
	D[4]	B0[4]	R0[4]	B1[4]	R1[4]
	D[3]	B0[3]	R0[3]	B1[3]	R1[3]
	D[2]	B0[2]	R0[2]	B1[2]	R1[2]
	D[1]	B0[1]	R0[1]	B0[1]	R1[1]
	D[0]	B0[0]	R0[0]	B0[0]	R1[0]

Note: The AX[7:0] data is ignored.

Table 8. YCrCb Muxed Mode

IDF# Format		9 YCrCb 8-bit							
Pixel#		P0a	P0b	P1a	P1b	P2a	P2b	P3a	P3b
Bus Data	D[7]	Cb0[7]	Y0[7]	Cr0[7]	Y1[7]	Cb2[7]	Y2[7]	Cr2[7]	Y3[7]
	D[6]	Cb0[6]	Y0[6]	Cr0[6]	Y1[6]	Cb2[6]	Y2[6]	Cr2[6]	Y3[6]
	D[5]	Cb0[5]	Y0[5]	Cr0[5]	Y1[5]	Cb2[5]	Y2[5]	Cr2[5]	Y3[5]
	D[4]	Cb0[4]	Y0[4]	Cr0[4]	Y1[4]	Cb2[4]	Y2[4]	Cr2[4]	Y3[4]
	D[3]	Cb0[3]	Y0[3]	Cr0[3]	Y1[3]	Cb2[3]	Y2[3]	Cr2[3]	Y3[3]
	D[2]	Cb0[2]	Y0[2]	Cr0[2]	Y1[2]	Cb2[2]	Y2[2]	Cr2[2]	Y3[2]
	D[1]	Cb0[1]	Y0[1]	Cr0[1]	Y1[1]	Cb2[1]	Y2[1]	Cr2[1]	Y3[1]
	D[0]	Cb0[0]	Y0[0]	Cr0[0]	Y1[0]	Cb2[0]	Y2[0]	Cr2[0]	Y3[0]

When IDF = 9 (YCrCb 8-bit mode), H and V sync signals can be embedded into the data stream. In this mode, the embedded sync will follow the CCIR656 convention, and the first byte of the “video timing reference code” will be assumed to occur when a Cb sample would occur if the video stream was continuous. This is delineated in Table 9 shown below.

Digital Video Interface (continued)

Table 9. YCrCb Multiplexed Mode with Embedded Syncs

IDF# Format		9 YCrCb 8-bit							
Pixel#		P0a	P0b	P1a	P1b	P2a	P2b	P3a	P3b
Bus Data	D[7]	1	0	0	S[7]	Cb2[7]	Y2[7]	Cr2[7]	Y3[7]
	D[6]	1	0	0	S[6]	Cb2[6]	Y2[6]	Cr2[6]	Y3[6]
	D[5]	1	0	0	S[5]	Cb2[5]	Y2[5]	Cr2[5]	Y3[5]
	D[4]	1	0	0	S[4]	Cb2[4]	Y2[4]	Cr2[4]	Y3[4]
	D[3]	1	0	0	S[3]	Cb2[3]	Y2[3]	Cr2[3]	Y3[3]
	D[2]	1	0	0	S[2]	Cb2[2]	Y2[2]	Cr2[2]	Y3[2]
	D[1]	1	0	0	S[1]	Cb2[1]	Y2[1]	Cr2[1]	Y3[1]
	D[0]	1	0	0	S[0]	Cb2[0]	Y2[0]	Cr2[0]	Y3[0]

In this mode the S[7:0] contains the following data:

- S[6] = F = 1 during field 2, 0 during field 1
- S[5] = V = 1 during field blanking, 0 elsewhere
- S[4] = H = 1 during EAV (the synchronization reference at the end of active video)
0 during SAV (the synchronization reference at the start of active video)

Bits S[7] and S[3..0] are ignored.

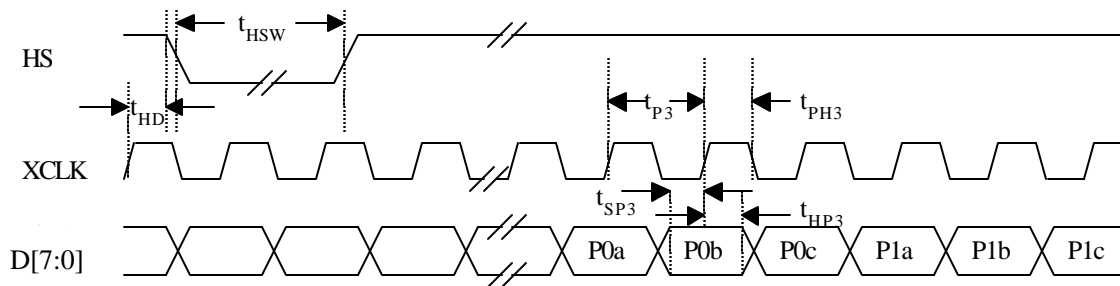

Figure 6: Multiplexed Pixel Data Transfer Mode (IDF = 6)

Table 10. RGB 8-bit Multiplexed Mode (24-bit Color)

IDF# Format		6 RGB 8-bit								
Pixel#		P0a	P0b	P0c	P1a	P1b	P1c	P2a	P2b	P2c
Bus Data	D[7]	B0[7]	G0[7]	R0[7]	B1[7]	G1[7]	R1[7]	B2[7]	G2[7]	R2[7]
	D[6]	B0[6]	G0[6]	R0[6]	B1[6]	G1[6]	R1[6]	B2[6]	G2[6]	R2[6]
	D[5]	B0[5]	G0[5]	R0[5]	B1[5]	G1[5]	R1[5]	B2[5]	G2[5]	R2[5]
	D[4]	B0[4]	G0[4]	R0[4]	B1[4]	G1[4]	R1[4]	B2[4]	G2[4]	R2[4]
	D[3]	B0[3]	G0[3]	R0[3]	B1[3]	G1[3]	R1[3]	B2[3]	G2[3]	R2[3]
	D[2]	B0[2]	G0[2]	R0[2]	B1[2]	G1[2]	R1[2]	B2[2]	G2[2]	R2[2]
	D[1]	B0[1]	G0[1]	R0[1]	B1[1]	G1[1]	R1[1]	B2[1]	G2[1]	R2[1]
	D[0]	B0[0]	G0[0]	R0[0]	B1[0]	G1[0]	R1[0]	B2[0]	G2[0]	R2[0]

Functional Description

The CH7013A is a TV-output companion chip to graphics controllers providing digital output in either YUV or RGB format. This solution involves both hardware and software elements which work together to produce an optimum TV screen image based on the original computer generated pixel data. All essential circuitry for this conversion are integrated on-chip. On-chip circuitry includes memory, memory control, scaling, PLL, DAC, filters, and NTSC/PAL encoder. All internal signal processing, including NTSC/PAL encoding, is performed using digital techniques to ensure that the high-quality video signals are not affected by drift issues associated with analog components. No additional adjustment is required during manufacturing.

CH7013A is ideal for PC motherboards, web browsers, or VGA add-in boards where a minimum of discrete support components (passive components, parallel resonance 14.31818 MHz crystal) are required for full operation.

Architectural Overview

The CH7013A is a complete TV output subsystem which uses both hardware and software elements to produce an image on TV which is virtually identical to the image that would be displayed on a monitor. Simply creating a compatible TV output from a VGA input involves a relatively straightforward process. This process includes a standard conversion from RGB to YUV color space, converting from a non-interlaced to an interlaced frame sequence, and encoding the pixel stream into NTSC or PAL compliant format. However, creating an optimum computer-generated image on a TV screen involves a highly sophisticated process of scaling, deflickering, and filtering. This results in a compatible TV output that displays a sharp and subtle image, of the right size, with minimal artifacts from the conversion process.

As a key part of the overall system solution, the CH7013A software establishes the correct framework for the VGA input signal to enable this process. Once the display is set to a supported resolution (either 640x480 or 800x600), the CH7013A software may be invoked to establish the appropriate TV output display. The software then programs the various timing parameters of the VGA controller to create an output signal that will be compatible with the chosen resolution, operating mode, and TV format. Adjustments performed in software include pixel clock rates, total pixels per line, and total lines per frame. By performing these adjustments in software, the CH7013A can render a superior TV image without the added cost of a full frame buffer memory – normally used to implement features such as scaling and full synchronization.

The CH7013A hardware accepts digital RGB or YCrCb inputs, which are latched in synchronization with the pixel clock. These inputs are then color-space converted into YUV in 4-2-2 format and stored in a line buffer memory. The stored pixels are fed into a block where scan-rate conversion, underscan scaling and 2-line, 3-line, 4-line and 5-line vertical flicker filtering are performed. The scan-rate converter transforms the VGA horizontal scan-rate to either NTSC or PAL scan rates; the vertical flicker filter eliminates flicker at the output while the underscan scaling reduces the size of the displayed image to fit onto a TV screen. The resulting YUV signals are filtered through digital filters to minimize aliasing problems. The digital encoder receives the filtered signals and transforms them to composite and S-Video outputs, which are converted by the three 9-bit DACs into analog outputs.

Color Burst Generation*

The CH7013A allows the sub-carrier frequency to be accurately generated from a 14.31818 MHz crystal oscillator, leaving the sub-carrier frequency independent of the sampling rate. As a result, the CH7013A may be used with any VGA chip (with an appropriate digital interface) since the CH7013A sub-carrier frequency can be generated without being dependent on the precise pixel rates of VGA controllers. This feature is a significant benefit, since even a $\pm 0.01\%$ sub-carrier frequency variation may be enough to cause some television monitors to lose color lock.

In addition, the CH7013A has the capability to genlock the color burst signal to the VGA horizontal sync frequency, which enables a fully synchronous system between the graphics controller and the television. When genlocked, the CH7013A can also stop “dot crawl” motion (for composite mode operation in NTSC modes) to eliminate the annoyance of moving borders. Both of these features are under programmable control through the register set.

Display Modes

The CH7013A display mode is controlled by three independent factors: input resolution, TV format, and scale factor, which are programmed via the display mode register. It is designed to accept input resolutions of 640x480, 800x600, 640x400 (including 320x200 scan-doubled output), 720x400, and 512x384. It is designed to support

Display Modes (continued)

output to either NTSC or PAL television formats. The CH7013A provides interpolated scaling with selectable factors of 5:4, 1:1, 7:8, 5:6, 3:4 and 7:10 in order to support adjustable overscan or underscan operation when displayed on a TV. This combination of factors results in a matrix of useful operating modes which are listed in detail in **Table 11**.

Table 11. CH7013A Display Modes

TV Format Standard	Input (active) Resolution	Scale Factor	Active TV Lines	Percent (1) Overscan	Pixel Clock	Horizontal Total	Vertical Total
NTSC	640x480	1:1	480	10%	24.671	784	525
NTSC	640x480	7:8	420	(3%)	28.196	784	600
NTSC	640x480	5:6	400	(8%)	30.210	800	630
NTSC	800x600	5:6	500	16%	39.273	1040	630
NTSC	800x600	3:4	450	4%	43.636	1040	700
NTSC	800x600	7:10	420	(3%)	47.832	1064	750
NTSC	640x400	5:4	500	16%	21.147	840	420
NTSC	640x400	1:1	400	(8%)	26.434	840	525
NTSC	640x400	7:8	350	(19%)	30.210	840	600
NTSC	720x400	5:4	500	16%	23.790	945	420
NTSC	720x400	1:1	400	(8%)	29.455	936	525
NTSC	512x384	5:4	480	10%	20.140	800	420
NTSC	512x384	1:1	384	(11%)	24.671	784	525
PAL	640x480	5:4	600	14%	21.000	840	500
PAL	640x480	1:1	480	(8%)	26.250	840	625
PAL	640x480	5:6	400	(29%)	31.500	840	750
PAL	800x600	1:1	600	14%	29.500	944	625
PAL	800x600	5:6	500	(4%)	36.000	960	750
PAL	800x600	3:4	450	(15%)	39.000	936	836
PAL	640x400	5:4	500	(4%)	25.000	1000	500
PAL	640x400	1:1	400	(29%)	31.500	1008	625
PAL	720x400	5:4	500	(4%)	28.125	1125	500
PAL	720x400	1:1	400	(29%)	34.875	1116	625
PAL	512x384	5:4	480	(8%)	21.000	840	500
PAL	512x384	1:1	384	(35%)	26.250	840	625

(1) **Note:**Percent underscan is a calculated value based on average viewable lines on each TV format, assuming an average TV overscan of 10%. (Negative values) indicate modes which are operating in underscan.
 For NTSC: 480 active lines - 10% (overscan) = 432 viewable lines (average)
 For PAL: 576 active lines - 10% (overscan) = 518 viewable lines (average)

The inclusion of multiple levels of scaling for each resolution have been created to enable optimal use of the CH7013A for different application needs. In general, underscan (modes where percent overscan is negative) provides an image that is viewable in its entirety on screen; it should be used as the default for most applications (e.g., viewing text screens, operating games, running productivity applications and working within Windows). Overscanning provides an image that extends past the edges of the TV screen, exactly like normal television programs and movies appear on TV, and is only recommended for viewing movies or video clips coming from the computer. In addition to the above mode table, the CH7013A also support interlaced input modes, both in CCIR 656 and proprietary formats (see Display Mode Register section.)

Flicker Filter and Text Enhancement

The CH7013A integrates an advanced 2-line, 3-line, 4-line and 5-line (depending on mode) vertical deflickering filter circuit to help eliminate the flicker associated with interlaced displays. This flicker circuit provides an adaptive filter algorithm for implementing flicker reduction with selections of high, medium or low flicker content for both luma and chroma channels (see register descriptions). In addition, a special text enhancement circuit incorporates

Display Modes (continued)

proprietary Algorithms for enhancing the readability of text. These modes are fully programmable via the serial port under the flicker filter register.

Internal Voltage Reference

An on-chip bandgap circuit is used in the DAC to generate a reference voltage which, in conjunction with a reference resistor at pin RSET, and register controlled divider, sets the output ranges of the DACs. The CH7013A bandgap reference voltage is 1.235 volts nominal for NTSC or PAL-M, or 1.317 volts nominal (for PAL or NTSC-J), which is determined by IDF register bit 6 (DACG bit). The recommended value for the reference resistor RSET is 360 ohms (though this may be adjusted in order to achieve a different output level). The gain setting for DAC output is 1/48th. Therefore, for each DAC, the current output per LSB step is determined by the following equation:

$$I_{LSB} = V(RSET)/RSET \text{ reference resistor} * 1/GAIN$$

For DACG=0, this is: $I_{LSB} = 1.235/360 * 1/48 = 71.4 \mu A$ (nominal)
 For DACG=1, this is: $I_{LSB} = 1.317/360 * 1/48 = 76.2 \mu A$ (nominal)

Power Management

The CH7013A supports five operating states including Normal [On], Power Down, Full Power Down, S-Video Off, and Composite Off to provide optimal power consumption for the application involved. Using the programmable power down modes accessed over the serial port, the CH7013A may be placed in either Normal state, or any of the four power managed states, as listed below (see “Power Management Register” under the *Register Descriptions* section for programming information). To support power management, a TV sensing function (see “Connection Detect Register” under the *Register Descriptions* section) is provided, which identifies whether a TV is connected to either S-Video or composite. This sensing function can then be used to enter into the appropriate operating state (e.g., if TV is sensed only on composite, the S-Video Off mode could be set by software).

Table 12. Power Management

Operating State	Functional Description
Normal (On):	In the normal operating state, all functions and pins are active
Power Down:	In the power-down state, most pins and circuitry are disabled. The BCO pin will continue to provide either the VCO divided by K3, or 14.318 MHz out, and the P-OUT pin will continue to output a clock reference.
S-Video Off:	Power is shut off to the unused DACs associated with S-Video outputs.
Composite Off:	In Composite-off state, power is shut off to the unused DAC associated with CVBS output.
Full Power Down:	In this power-down state, all but the I ² C circuits are disabled. This places the CH7013A in its lowest power consumption mode.

Luminance and Chrominance Filter Options

The CH7013A contains a set of luminance filters to provide a controllable bandwidth output on both CVBS and S-Video outputs. All values are completely programmable via the Video Bandwidth Register. For all graphs shown, the horizontal axis is frequency in MHz, and the vertical axis is attenuation in dBs. The composite luminance and chrominance video bandwidth output is shown in **Table 13**.

VBI Pass-Through Support

The CH7013A provides the ability to pass-through data with minimal filtering, on vertical blanking lines 10-21 for Intercast or close captioned applications (see register descriptions).

Table 13. Video Bandwidth

Mode	Chrominance				Luminance Bandwidth with Sin(X) / X (MHz)							
	Bandwidth (MHz)				CVBS		S-Video			S-Video		
	CBW[1:0]				YCV		YSV[1:0], YPEAK = 0			YSV[1:0], YPEAK = 1		
	00	01	10	11	0	1	00	01	1X	00	01	1X
0	0.62	0.68	0.80	0.95	2.26	3.37	2.26	3.37	5.23	2.57	4.44	5.23
1	0.78	0.85	1.00	1.18	2.82	4.21	2.82	4.21	6.53	3.21	5.56	6.53
2	0.53	0.58	0.68	0.81	1.93	2.87	1.93	2.87	4.46	2.19	3.79	4.46
3	0.65	0.71	0.83	0.99	2.36	3.52	2.36	3.52	5.46	2.68	4.64	5.46
4	0.83	0.91	1.07	1.27	3.03	4.51	3.03	4.51	7.00	3.44	5.95	7.00
5	1.03	1.13	1.32	1.57	3.75	5.59	3.75	5.59	8.68	4.27	7.38	8.68
6	0.70	0.77	0.90	1.07	2.56	3.81	2.56	3.81	5.92	2.91	5.04	5.92
7	0.87	0.95	1.12	1.33	3.17	4.72	3.17	4.72	7.33	3.60	6.23	7.33
8	0.74	0.81	0.95	1.13	2.69	4.01	2.69	4.01	6.22	3.06	5.29	6.22
9	0.93	1.02	1.20	1.42	3.39	5.05	3.39	5.05	7.84	3.85	6.67	7.84
10	0.63	0.68	0.80	0.95	2.28	3.39	2.28	3.39	5.26	2.59	4.48	5.26
11	0.78	0.86	1.00	1.19	2.84	4.24	2.84	4.24	6.58	3.23	5.59	6.58
12	0.89	0.98	1.15	1.36	3.25	4.84	3.25	4.84	7.52	3.70	6.39	7.52
13	0.62	0.68	0.80	0.95	2.26	3.37	2.26	3.37	5.23	2.57	4.44	5.23
14	0.78	0.85	1.00	1.18	2.82	4.21	2.82	4.21	6.53	3.21	5.56	6.53
15	0.93	1.02	1.20	1.42	3.39	5.05	3.39	5.05	7.84	3.85	6.67	7.84
16	0.64	0.71	0.83	0.98	2.35	3.50	2.35	3.50	5.43	2.67	4.62	5.43
17	0.74	0.81	0.95	1.13	2.70	4.02	2.70	4.02	6.24	3.07	5.30	6.24
18	0.79	0.87	1.02	1.21	2.89	4.31	2.89	4.31	6.68	3.29	5.68	6.68
19	0.77	0.85	1.00	1.18	2.82	4.20	2.82	4.20	6.53	3.21	5.55	6.53
20	0.95	1.03	1.22	1.44	3.44	5.13	3.44	5.13	7.97	3.92	6.77	7.97
21	1.02	1.12	1.32	1.56	3.73	5.56	3.73	5.56	8.63	4.24	7.34	8.63
22	0.77	0.85	0.99	1.18	2.82	4.20	2.82	4.20	6.52	3.20	5.54	6.52
23	0.86	0.94	1.11	1.31	3.13	4.66	3.13	4.66	7.24	3.56	6.16	7.24
24	0.94	1.03	1.21	1.44	3.43	5.11	3.43	5.11	7.94	3.90	6.75	7.94
25	0.71	0.78	0.91	1.08	2.58	3.85	2.58	3.85	5.97	2.94	5.08	5.97
26	0.71	0.78	0.91	1.08	2.58	3.85	2.58	3.85	5.97	2.94	5.08	5.97
27	0.47	0.51	0.60	0.71	1.70	2.53	1.70	2.53	3.92	1.93	3.34	3.92
28	0.38	0.41	0.48	0.57	1.37	2.04	1.37	2.04	3.17	1.56	2.69	3.17

The composite luminance and chrominance frequency response is depicted in **Figure 7** through **9**.

Luminance and Chrominance Filter Options (continued)

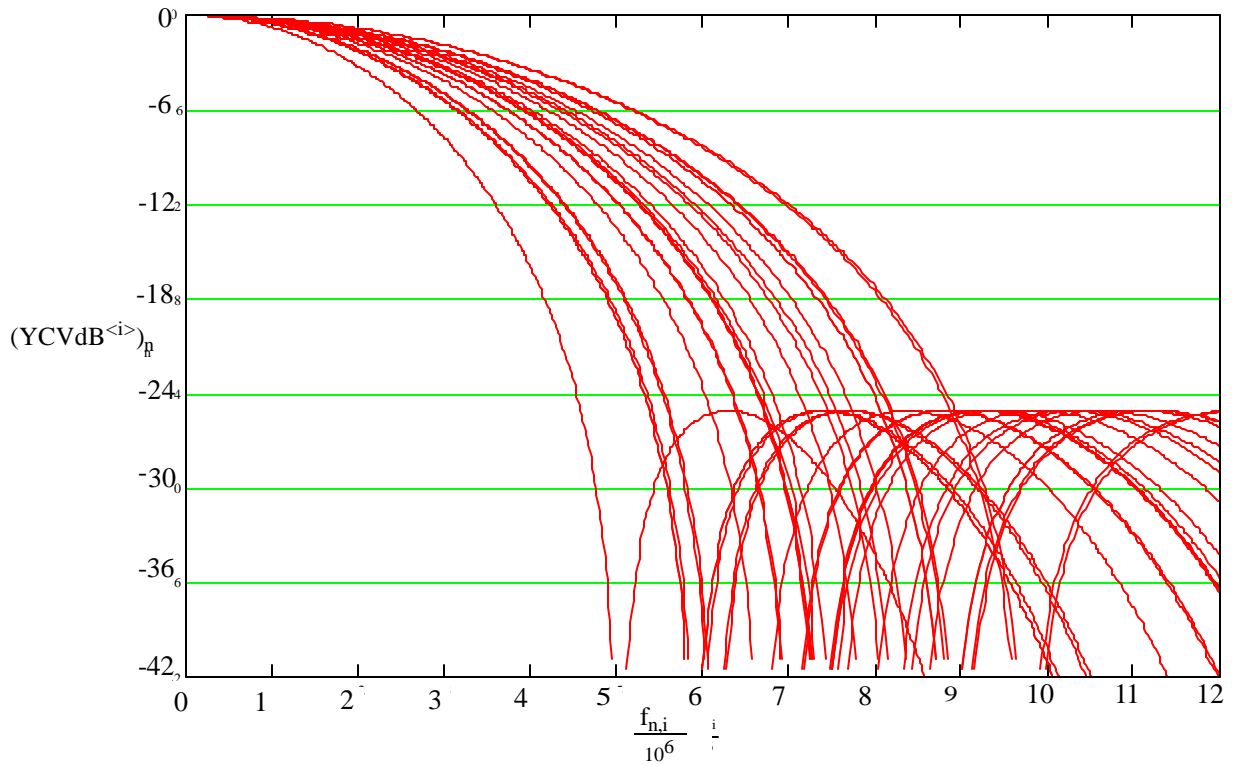

Figure 7: Composite Luminance Frequency Response (YCV = 0)

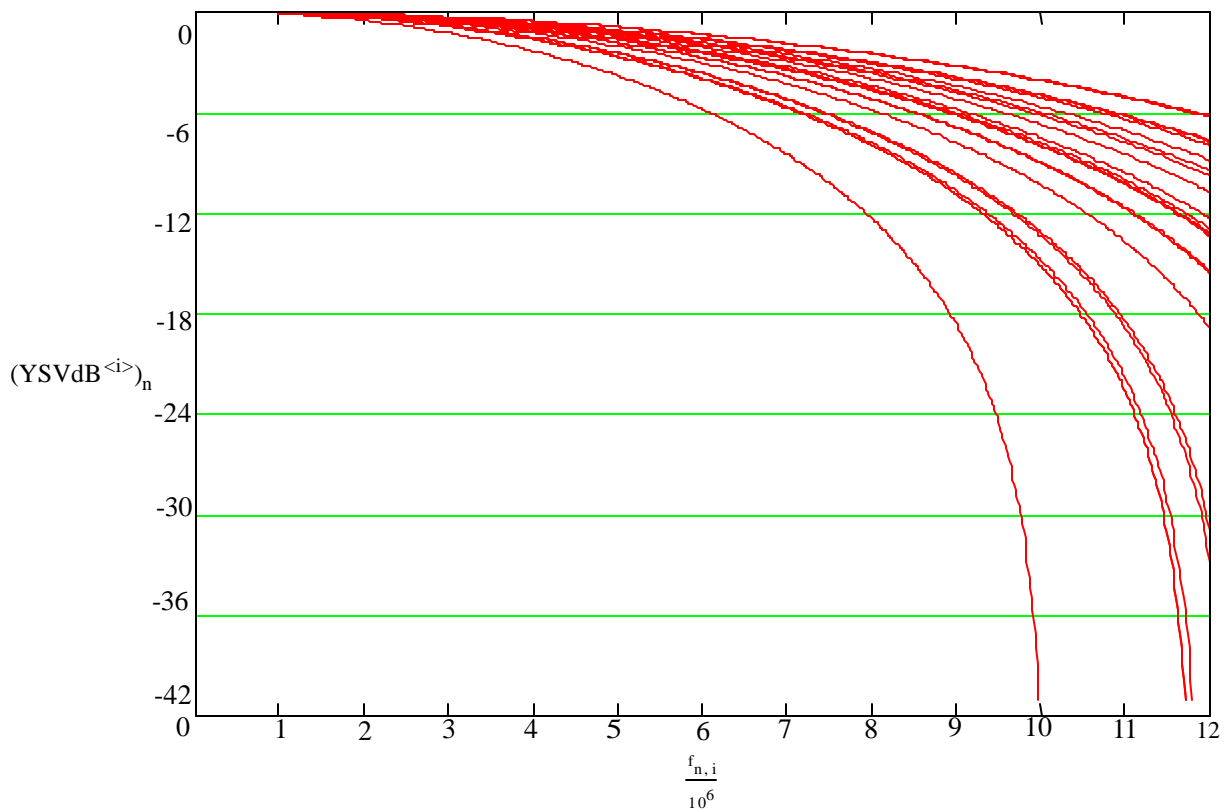

Figure 8: S-Video Luminance Frequency Response (YSV = 1X, YPEAK = 0)

Luminance and Chrominance Filter Options (*continued*)

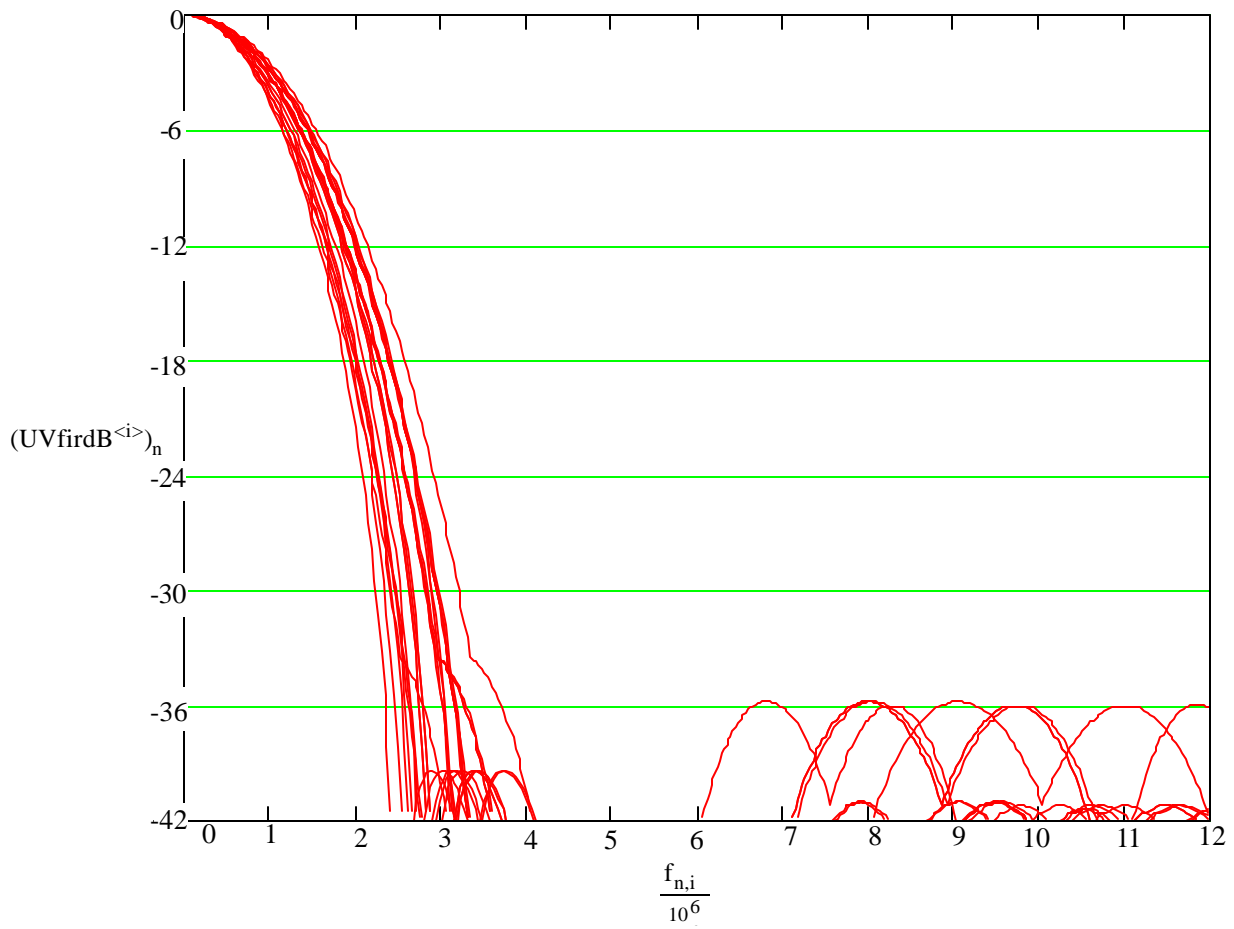

Figure 9: Chrominance Frequency Response

NTSC and PAL Operation

Composite and S-Video outputs are supported in either NTSC or PAL format. The general parameters used to characterize these outputs are listed in **Table14** and shown in **Figure10**. (See **Figure13** through **18** for illustrations of composite and S-Video output waveforms.)

CCIR624-3 Compliance

The CH7013A is predominantly compliant with the recommendations called out in CCIR624-3. The following are the only exceptions to this compliance:

- The frequencies of Fsc, Fh, and Fv can only be guaranteed in master or pseudo-master modes, not in slave mode when the graphics device generates these frequencies.
- It is assumed that gamma correction, if required, is performed in the graphics device which establishes the color reference signals.
- All modes provide the exact number of lines called out for NTSC and PAL modes respectively, except mode 21, which outputs 800x600 resolution, scaled by 3:4, to PAL format with a total of 627 lines (vs. 625).
- Chroma signal frequency response will fall within 10% of the exact recommended value.
- Pulse widths and rise/fall times for sync pulses, front/back porches, and equalizing pulses are designed to approximate CCIR624-3 requirements, but will fall into a range of values due to the variety of clock frequencies used to support multiple operating modes

Table 14. NTSC/PAL Composite Output Timing Parameters (in μ S)

Symbol	Description	Level (mV)		Duration (μ S)	
		NTSC	PAL	NTSC	PAL
A	Front Porch	287	300	1.49 - 1.51	1.48 - 1.51
B	Horizontal Sync	0	0	4.69 - 4.72	4.69 - 4.71
C	Breezeway	287	300	0.59 - 0.61	0.88 - 0.92
D	Color Burst	287	300	2.50 - 2.53	2.24 - 2.26
E	Back Porch	287	300	1.55 - 1.61	2.62 - 2.71
F	Black	340	300	0.00 - 7.50	0.00 - 8.67
G	Active Video	340	300	37.66 - 52.67	34.68 - 52.01
H	Black	340	300	0.00 - 7.50	0.00 - 8.67

For this table and all subsequent figures, key values are:

- Note:**
1. RSET = 360 ohms; V(RSET) = 1.235V; 75 ohms doubly terminated load.
 2. Durations vary slightly in different modes due to the different clock frequencies used.
 3. Active video and black (F, G, H) times vary greatly due to different scaling ratios used in different modes.
 4. Black times (F and H) vary with position controls.

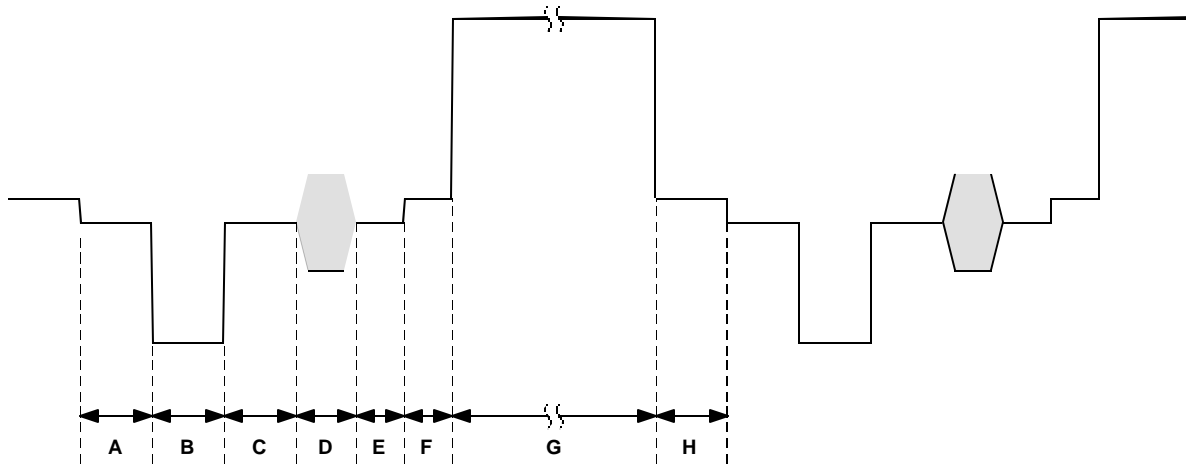

Figure 10: NTSC / PAL Composite Output

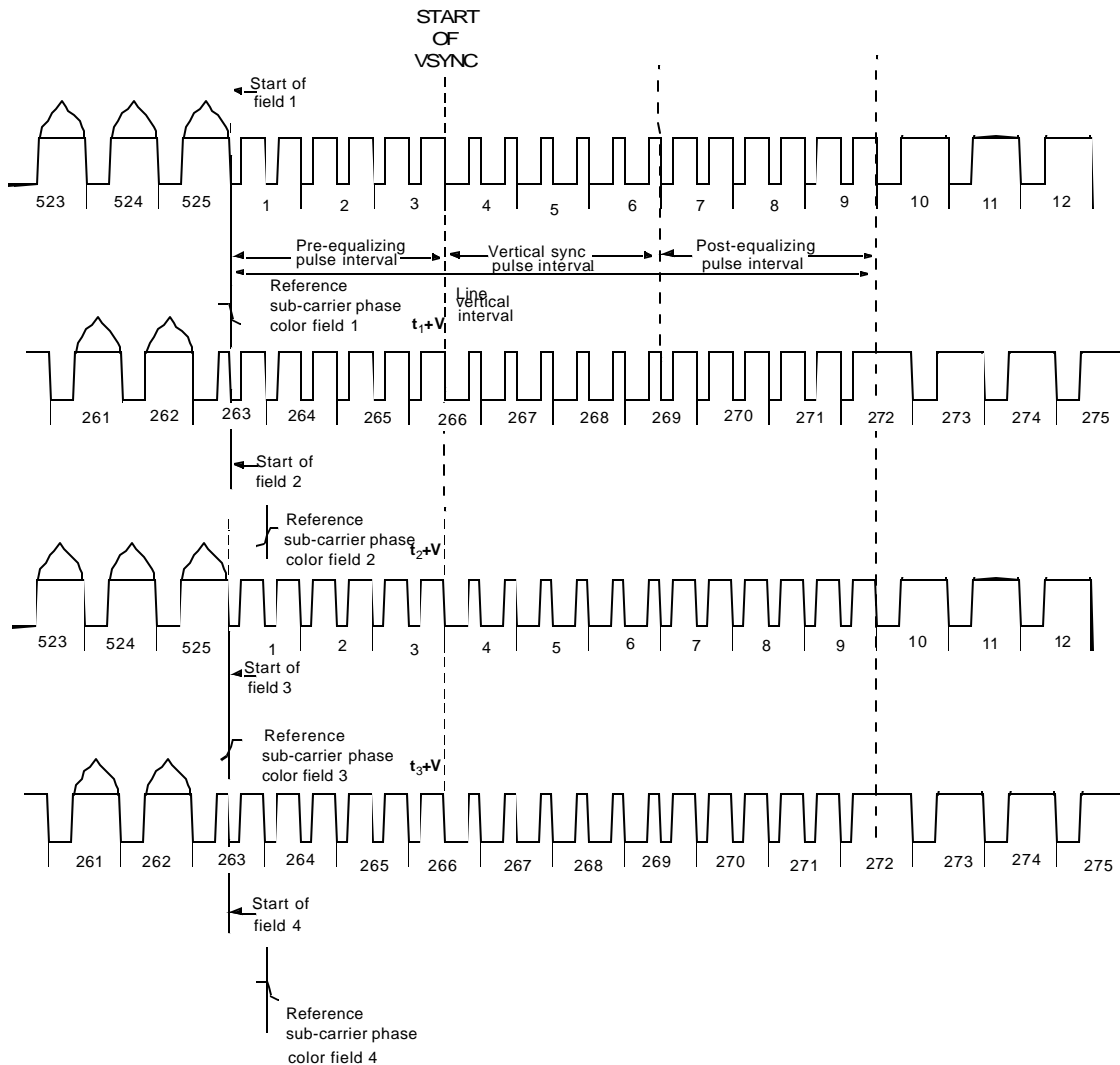

Figure 11: Interlaced NTSC Video Timing

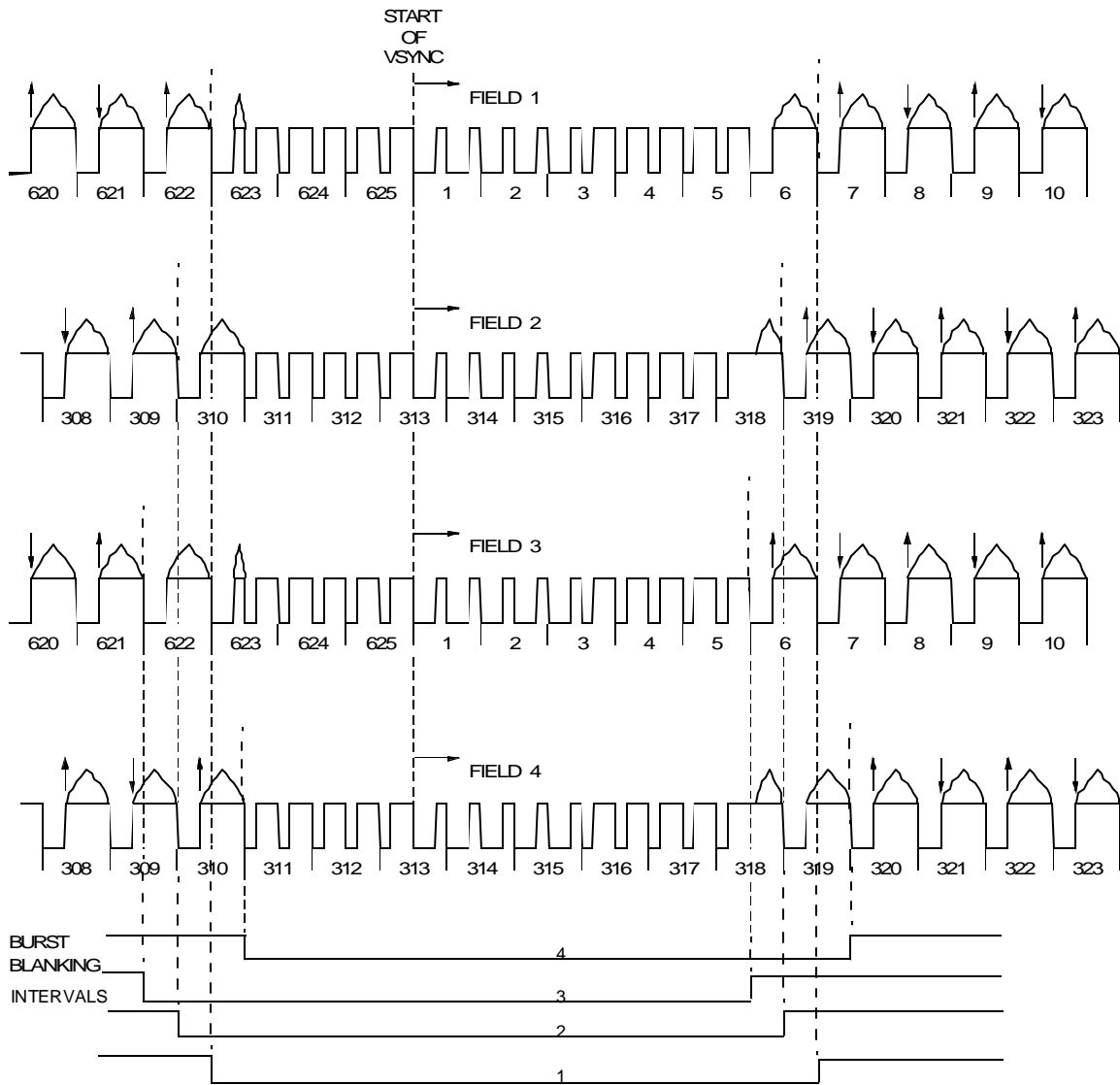

Figure 12: Interlaced PAL Video Timing

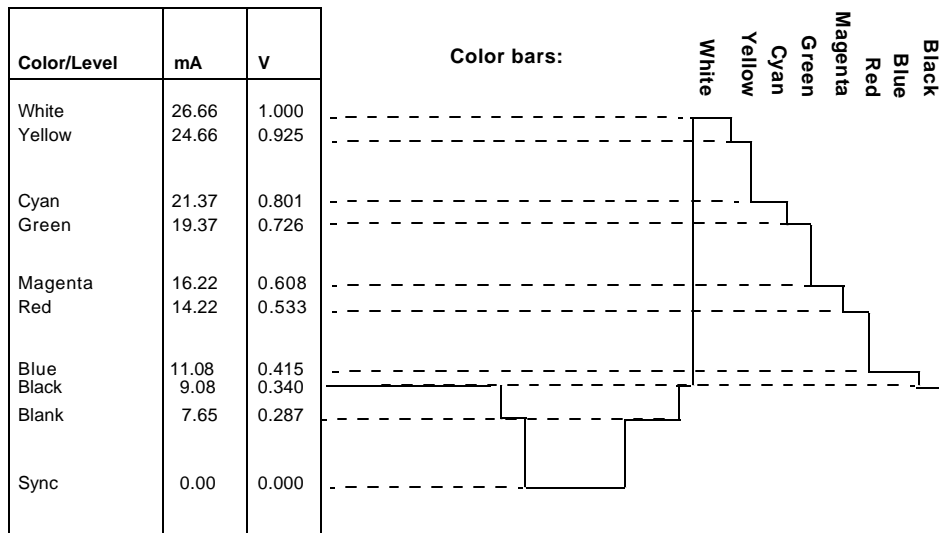

Figure 13: NTSC Y (Luminance) Output Waveform (DACG = 0)

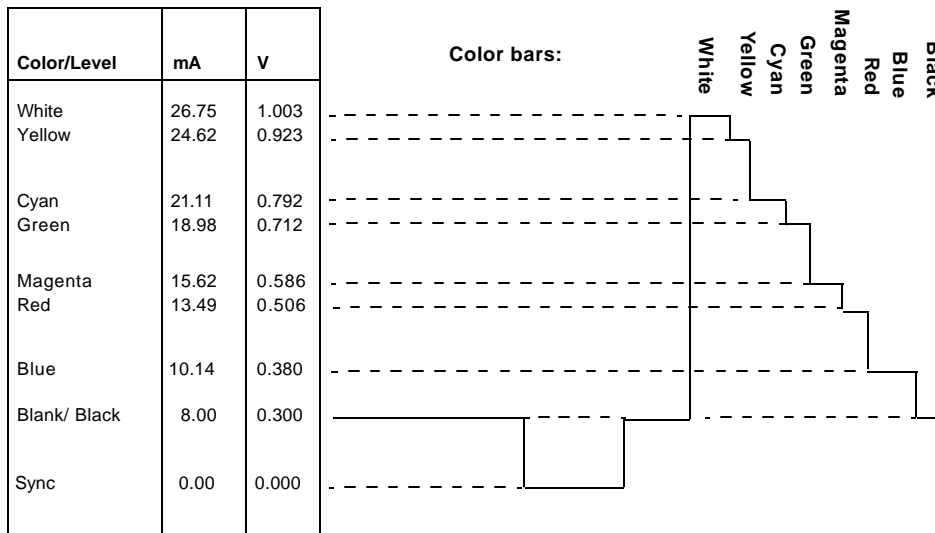

Figure 14: PAL Y (Luminance) Video Output Waveform (DACG = 1)

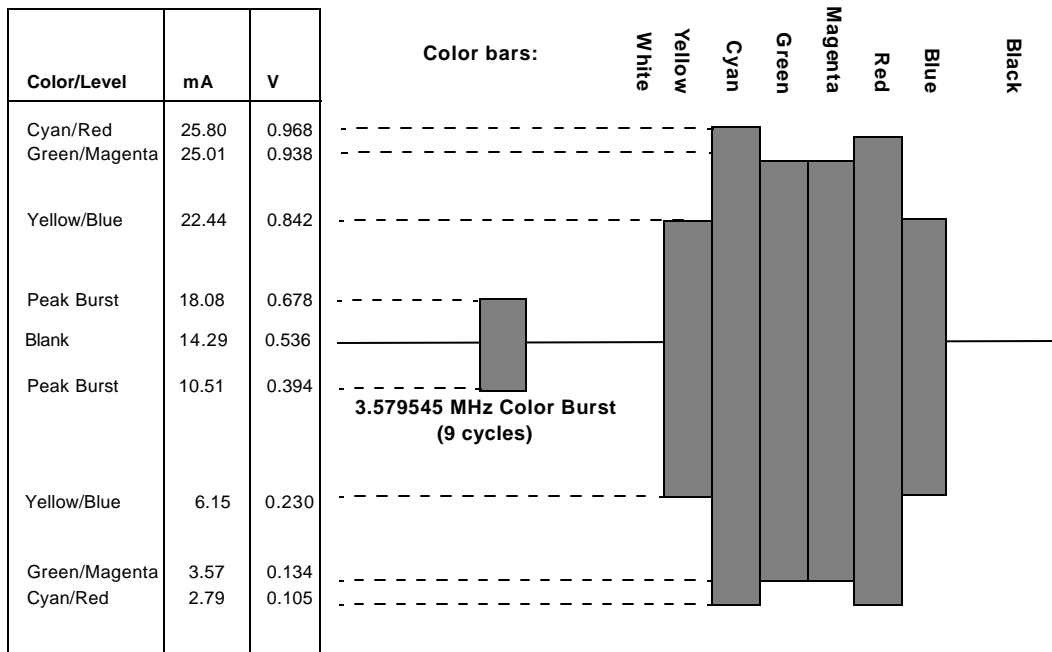

Figure 15: NTSC C (Chrominance) Video Output Waveform (DACG = 0)

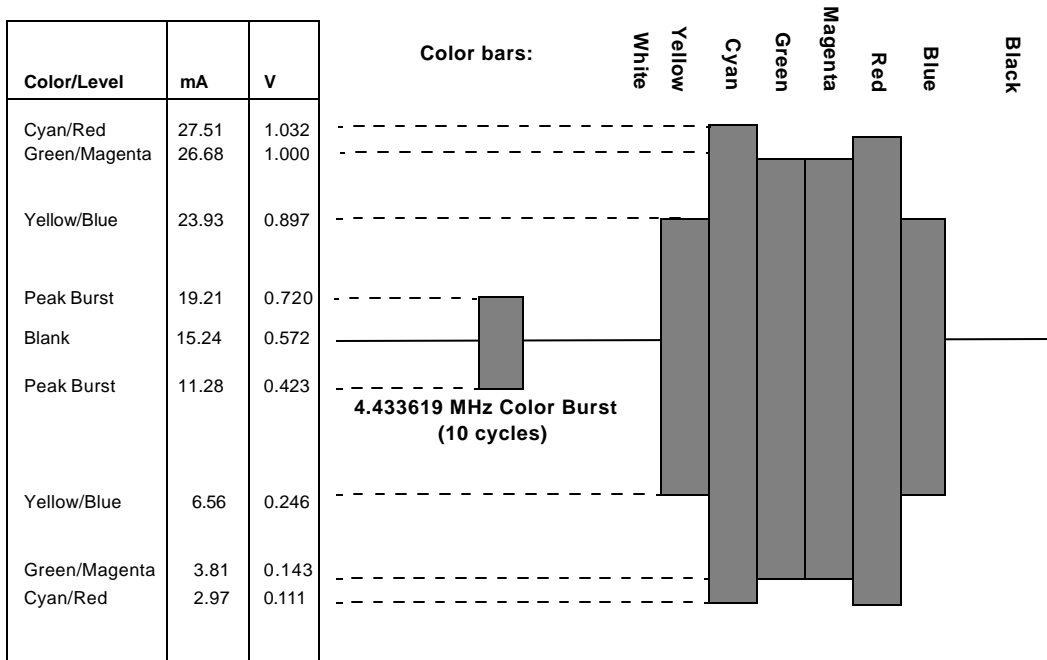

Figure 16: PAL C (Chrominance) Video Output Waveform (DACG = 1)

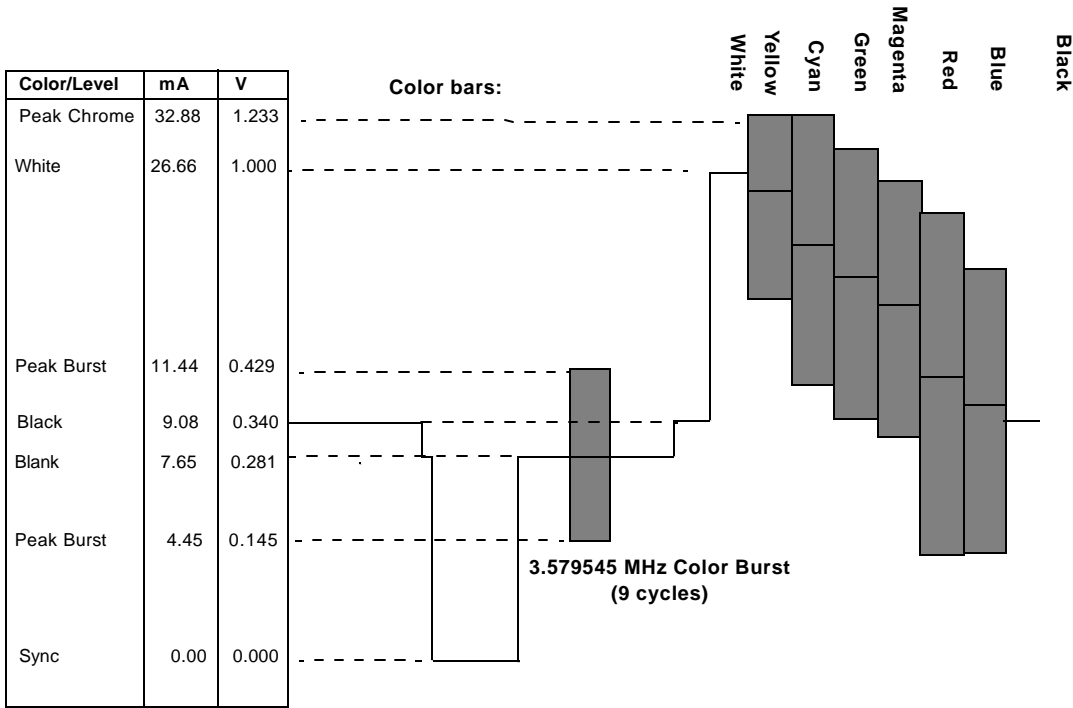

Figure 17: Composite NTSC Video Output Waveform (DACG = 0)

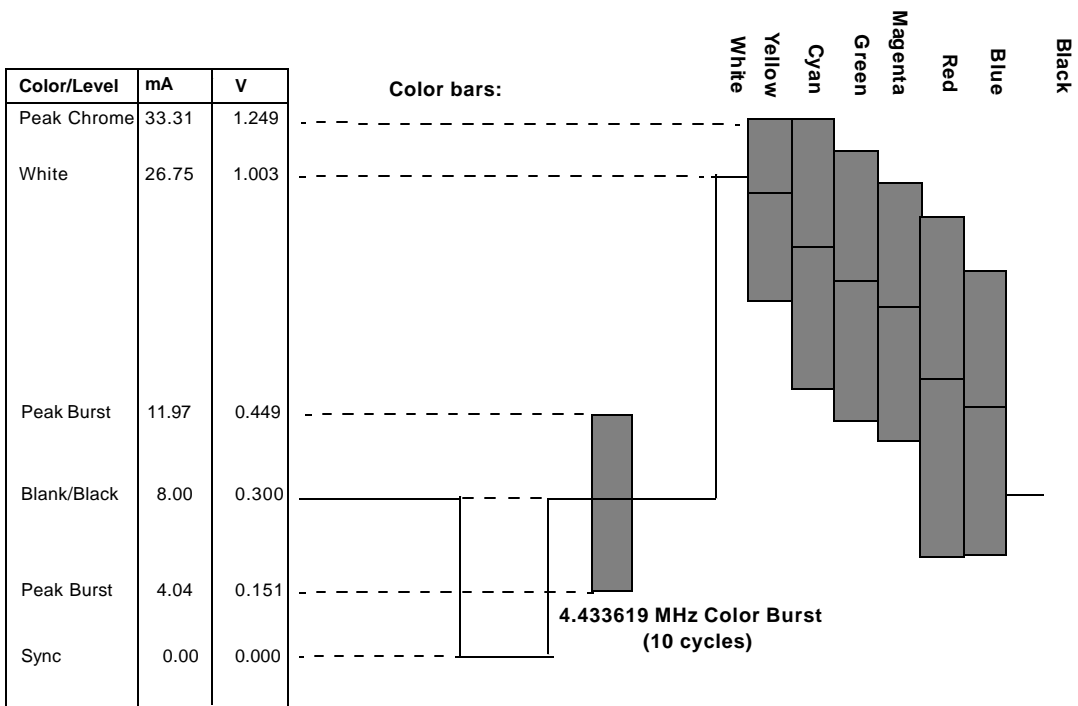

Figure 18: Composite PAL Video Output Waveform (DACG = 1)

Registers and Programming

The CH7013A is a fully programmable device, providing for full functional control through a set of registers accessed from the serial port. The CH7013A contains a total of 37 registers, which are listed in **Table 15** and described in detail under *Register Descriptions*. Detailed descriptions of operating modes and their effects are contained in the previous section, *Functional Description*. An addition (+) sign in the Bits column below signifies that the parameter contains more than 8 bits, and the remaining bits are located in another register.

Table 15. Register Map

Register	Symbol	Address	Bits	Functional Summary
Display Mode	DMR	00H	8	Display mode selection
Flicker Filter	FFR	01H	6	Flicker filter mode selection
Video Bandwidth	VBW	03H	7	Luma and chroma filter bandwidth selection
Input Data Format	IDF	04H	7	Data format and bit-width selections
Clock Mode	CM	06H	8	Sets the clock mode to be used
Start Active Video	SAV	07H	8+	Active video delay setting
Position Overflow	PO	08H	3	MSB bits of position values
Black Level	BLR	09H	8	Black level adjustment input latch clock edge select
Horizontal Position	HPR	0AH	8+	Enables horizontal movement of displayed image on TV
Vertical Position	VPR	0BH	8+	Enables vertical movement of displayed image on TV
Sync Polarity	SPR	0DH	4	Determines the horizontal and vertical sync polarity
Power Management	PMR	0EH	5	Enables power saving modes
Connection Detect	CDR	10H	4	Detection of TV presence
Contrast Enhancement	CE	11H	3	Contrast enhancement setting
PLL M and N extra bits	MNE	13H	5	Contains the MSB bits for the M and N PLL values
PLL-M Value	PLLM	14H	8+	Sets the PLL M value - bits (7:0)
PLL-N Value	PLLN	15H	8+	Sets the PLL N value - bits (7:0)
Buffered Clock	BCO	17H	6	Determines the clock output at pin 41
Subcarrier Frequency Adjust	FSCI	18H -1FH	4 or 8 each	Determines the subcarrier frequency
PLL and Memory Control	PLLC	20H	6	Controls for the PLL and memory sections
CIV Control	CIVC	21H	5	Control of CIV value
Calculated Fsc Increment Value	CIV	22H - 24H	8 each	Readable register containing the calculated subcarrier increment value
Version ID	VID	25H	8	Device version number
Test	TR	26H - 29H	30	Reserved for test (details not included herein)
Address	AR	3FH	6	Current register being addressed

Register Descriptions (continued)

Table 16. Alternate Register Map (Note: Macrovision™ controls available only by special arrangement)

Register	Bit 7	Bit 6	Bit 5	Bit 4	Bit 3	Bit 2	Bit 1	Bit 0
00H	IR2	IR1	IRO	VOS1	VOS0	SR2	SR1	SR0
01H			FC1	FC0	FY1	FY0	FT1	FT0
02H								
03H	FLFF	CVBW	CBW1	CBW0	YPEAK	YSV1	YSV0	YCV
04H		DACG	RGBBP		IDF3	IDF2	IDF1	IDF0
05H								
06H	CFRB	M/S*	Reserved	MCP	XCM1	XCM0	PCM1	PCM0
07H	SAV7	SAV6	SAV5	SAV4	SAV3	SAV2	SAV1	SAV0
08H						SAV8	HP8	VP8
09H	BL7	BL6	BL5	BL4	BL3	BL2	BL1	BL0
0AH	HP7	HP6	HP5	HP4	HP3	HP2	HP1	HP0
0BH	VP7	VP6	VP5	VP4	VP3	VP2	VP1	VP0
0CH								
0DH					DES	SYO	VSP	HSP
0EH				SCART	Reset*	PD2	PD1	PD0
0FH								
10H					YT	CT	CVBST	SENSE
11H						CE2	CE1	CE0
12H								
13H				Reserved	Reserved	N9	N8	M8
14H	M7	M6	M5	M4	M3	M2	M1	M0
15H	N7	N6	N5	N4	N3	N2	N1	N0
16H								
17H			SHF2	SHF1	SHF0	SCO2	SCO1	SCO0
18H					FSCI31	FSCI30	FSCI29	FSCI28
19H					FSCI27	FSCI26	FSCI25	FSCI24
1AH					FSCI23	FSCI22	FSCI21	FSCI20
1BH	GPIOIN3	GPIOIN2	GPIOIN1	GPIOIN0	FSCI19	FSCI18	FSCI17	FSCI16
1CH	GOENB3	GOENB2	GOENB1	GOENB0	FSCI15	FSCI14	FSCI13	FSCI12
1DH					FSCI11	FSCI10	FSCI9	FSCI8
1EH					FSCI7	FSCI6	FSCI5	FSCI4
1FH					FSCI3	FSCI2	FSCI1	FSCI0
20H			PLLCPI	PLLCAP	PLLS	PLL5VD	PLL5VA	MEM5V
21H				CIV25	CIV24	CIVH1	CIVH0	ACIV
22H	CIV23	CIV22	CIV21	CIV20	CIV19	CIV18	CIV17	CIV16
23H	CIV15	CIV14	CIV13	CIV12	CIV11	CIV10	CIV9	CIV8
24H	CIV7	CIV6	CIV5	CIV4	CIV3	CIV2	CIV1	CIVO
25H	VID7	VID6	VID5	VID4	VID3	VID2	VID1	VID0
26H	TS3	TS2	TS1	TS0	RSA	BST	NST	TE
27H			MS2	MS1	MS0	MTD	YLM8	CLM8
28H	YLM7	YLM6	YLM5	YLM4	YLM3	YLM2	YLM1	YLM0
29H	CLM7	CLM6	CLM5	CLM4	CLM3	CLM2	CLM1	CLM0
3FH	Reserved	Reserved	AR5	AR4	AR3	AR2	AR1	AR0

Register Descriptions (continued)

Display Mode Register

Symbol: DMR
Address: 00H
Bits: 8

Bit:	7	6	5	4	3	2	1	0
Symbol:	IR2	IR1	IR0	VOS1	VOS0	SR2	SR1	SR0
Type:	R/W	R/W	R/W	R/W	R/W	R/W	R/W	R/W
Default:	0	1	1	0	1	0	1	0

This register provides programmable control of the CH7013A display mode, including input resolution (IR[2:0]), output TV standard (VOS[1:0]), and scaling ratio (SR[2:0]). The mode of operation is determined according to the table below (default is 640x480 input, NTSC output, 7/8's scaling).

Table 17. Display Modes

Mode	IR[2:0]	VOS [1:0]	SR [2:0]	Input Data Format (Active Video)	Total Pixels/Line x Total Lines/Frame	Output Format	Scaling	Pixel Clock (MHz)
0	000	00	000	512x384	840x500	PAL	5/4	21.000000
1	000	00	001	512x384	840x625	PAL	1/1	26.250000
2	000	01	000	512x384	800x420	NTSC	5/4	20.139860
3	000	01	001	512x384	784x525	NTSC	1/1	24.671329
4	001	00	000	720X400	1125X500	PAL	5/4	28.125000
5	001	00	001	720x400	1116x625	PAL	1/1	34.875000
6	001	01	000	720x400	945x420	NTSC	5/4	23.790210
7	001	01	001	720x400	936x525	NTSC	1/1	29.454545
8	010	00	010	640x400	1000x500	PAL	5/4	25.000000
9	010	00	001	640x400	1008x625	PAL	1/1	31.5000000
10	010	01	000	640x400	840x420	NTSC	5/4	21.146853
11	010	01	001	640x400	840x525	NTSC	1/1	26.433566
12	010	01	010	640x400	840x600	NTSC	7/8	30.209790
13	011	00	000	640x480	840x500	PAL	5/4	21.000000
14	011	00	001	640x480	840x625	PAL	1/1	26.250000
15	011	00	011	640x480	840x750	PAL	5/6	31.5000000
16	011	01	001	640x480	784x525	NTSC	1/1	24.671329
17	011	01	010	640x480	784x600	NTSC	7/8	28.195804
18	011	01	011	640x480	800x630	NTSC	5/6	30.209790
19	100	00	001	800x600	944x625	PAL	1/1	29.500000
20	100	00	011	800x600	960x750	PAL	5/6	36.0000000
21	100	00	100	800x600	936x836	PAL	3/4	39.000000
22	100	01	011	800x600	1040x630	NTSC	5/6	39.272727
23	100	01	100	800x600	1040x700	NTSC	3/4	43.636364
24	100	01	101	800x600	1064x750	NTSC	7/10	47.832168
25*	101	00	001	720x576	864x625	PAL	1/1	13.500000
26*	101	01	001	720x480	858x525	NTSC	1/1	13.500000
27*	110	00	001	800x500	1135x625	PAL	1/1	17.734375
28*	110	01	001	640X400	910X525	NTSC	1/1	14.318182

* Interlaced modes of operation. (For those modes, some functions will be bypassed. For details, please contact the application department.)

Register Descriptions (continued)

VOS[1:0]	00	01	10	11
Output Format	PAL	NTSC	PAL-M	NTSC-J

Flicker Filter Register

Symbol: FFR
Address: 01H
Bits: 6

Bit:	7	6	5	4	3	2	1	0
Symbol:			FC1	FC0	FY1	FY0	FT1	FT0
Type:			R/W	R/W	R/W	R/W	R/W	R/W
Default:			1	1	0	0	1	0

The flicker filter register provides for adjusting the operation of the various filters used in rendering the on-screen image. Adjusting settings between minimal and maximal values enables optimization between sharpness and flicker content. The FC[1:0] bits determine the settings for the chroma channel. The FT[1:0] bits determine the settings for the text enhancement circuit. The FY[1:0] bits determine the settings for the luma channel. In addition, the Chroma channel filtering includes a setting to enable the chroma dot crawl reduction circuit.

Note: When writing to register 01H, FY[1:0] is bits 3:2. FT[1:0] is bits 1:0. When reading from the register 01H, FY [1:0] is bits 1:0 and FT[1:0] is bits 3:2.

Table 18. Flicker Filter Settings

FY[1:0]	Settings for Luma Channel
00	Minimal Flicker Filtering
01	Slight Flicker Filtering
10	Maximum Flicker Filtering
11	Invalid
FT[1:0]	Settings for Text Enhancement Circuit
00	Maximum Text Enhancement
01	Slight Text Enhancement
10	Minimum Text Enhancement
11	Invalid
FC[1:0]	Settings for Chroma Channel
00	Minimal Flicker Filtering
01	Slight Flicker Filtering
10	Maximum Flicker Filtering
11	Enable Chroma DotCrawl Reduction

Register Descriptions (*continued*)

Video Bandwidth Register

Symbol: VBW
 Address: 03H
 Bits: 8

Bit:	7	6	5	4	3	2	1	0
Symbol:	FLFF	CVBW	CBW1	CBW0	YPEAK	YSV1	YSV0	YCV
Type:	R/W	R/W	R/W	R/W	R/W	R/W	R/W	R/W
Default:	0	0	0	0	0	0	0	0

This register enables the selection of alternative filters for use in the luma and chroma channels. There are currently four filter options defined for the chroma channel, 4 filter options in the S-Video luma channel and two filter options in the composite luma channel. The **Table 19** and **Table 20** below show the various settings.

Table 19. Luma Filter Bandwidth

YCV	Luma Composite Video Filter Adjust
0	Low bandwidth
1	High bandwidth
YSV[1:0]	Luma S-Video Filter Adjust
00	Low bandwidth
01	Medium bandwidth
10	High bandwidth
11	Reserved (decode this and handle the same as 10)
YPEAK	Disables the Y-peaking circuit
0	Disables the peaking filter in luma S-Video channel
1	Enables the peaking filter in luma S-Video channel

Table 20. Chroma Filter Bandwidth

CBW[1:0]	Luma Composite Video Filter Adjust
0 0	Low bandwidth
0 1	Medium bandwidth
1 0	Med-high bandwidth
1 1	High bandwidth

Bit 6 (CVBW) outputs the S-Video luma signal on both the S-Video luma output and the CVBS output. A "1" in this location enables the output of a black and white image on composite, thereby eliminating the degrading effects of the color signal (such as dot crawl or false colors), which is useful for viewing text with high accuracy.

Bit 7 (FLFF) controls the flicker filter used in the 7/10's scaling modes. In these scaling modes, setting FLFF to 1 causes a five line flicker filter to be used. The default setting of 0 uses a four line flicker filter.

Register Descriptions (*continued*)

Input Data Format Register

Symbol: IDF
Address: 04H
Bits: 6

Bit:	7	6	5	4	3	2	1	0
Symbol:		DACG	RGBBP		IDF3	IDF2	IDF1	IDF0
Type:		R/W	R/W		R/W	R/W	R/W	R/W
Default:		0	0		0	0	0	0

This register sets the variables required to define the incoming pixel data stream.

Table 21. Input Data Format

IDF[3:0]	Description
0000	16-bit non-multiplexed RGB (16-bit color, 565) input
0001	16-bit non-multiplexed YCrCb (24-bit color) input (Y non-multiplexed, CrCb multiplexed)
0010	16-bit multiplexed RGB (24-bit color) input
0011	15-bit non-multiplexed RGB (15-bit color, 555) input
0100	12-bit multiplexed RGB (24-bit color) input ("C" multiplex scheme)
0101	12-bit multiplexed RGB2 (24-bit color) input ("I" multiplex scheme)
0110	8-bit multiplexed RGB (24-bit color, 888) input
0111	8-bit multiplexed RGB (16-bit color, 565) input
1000	8-bit multiplexed RGB (15-bit color, 555) input
1001-1111	8-bit multiplexed YCrCb (24-bit color) input (Y, Cr and Cb are multiplexed)

RGBBP (bit 5): Setting this bit enables the RGB pass-through mode. Setting this bit to a 1 causes the input RGB signal to be directly output at the DACs (subject to a pipeline delay). If RGBBP=0, the bypass mode is disabled.

DACG (bit 6): This bit controls the gain of the D/A converters. When DACG=0, the nominal DAC current is 71 μ A, which provides the correct levels for NTSC and PAL-M. When DACG=1, the nominal DAC current is 76 μ A, which provides the correct levels for PAL and NTSC-J.

Clock Mode Register

Symbol: CM
Address: 06H
Bits: 8

Bit:	7	6	5	4	3	2	1	0
Symbol:	CFRB	M/S*	Reserved	MCP	XCM1	XCM0	PCM1	PCM0
Type:	R/W	R/W	R/W	R/W	R/W	R/W	R/W	R/W
Default:	0	0	0	1	0	0	0	0

The setting of the clock mode bits determines the clocking mechanism used in the CH7013A. The clock modes are shown in the table below. PCM controls the frequency of the pixel clock, and XCM identifies the frequency of the XCLK input clock.

Register Descriptions (continued)

Note: For what was formerly defined as the master mode, the user must now externally connect the P-OUT clock to the XCLK input pin. Although it is possible to set the XCM [1:0] and PCM[1:0] values independent of the input data format, there are only certain combinations of input data format, XCM and PCM, that will result in valid data being demultiplexed at the input of the device. Refer to the “Input Data Format Register” for these combinations.

Note: Display modes 25 and 26 must use a 2X multiplexed input data format and a 2X XCLK. Display modes 27 and 28 must use a 1X XCLK input data format.

Table 22. Input Data Format Register

XCM[1:0]	PCM[1:0]	XCLK	P-OUT	Input Data Modes Supported
00	00	1X	1X	0, 1, 2, 3, 4, 5, 7, 8, 9
00	01	1X	2X	0, 1, 2, 3, 4, 5, 7, 8, 9
00	1X	1X	3X	0, 1, 2, 3, 4, 5, 7, 8, 9
01	00	2X	1X	2, 4, 5, 7, 8, 9
01	01	2X	2X	2, 4, 5, 7, 8, 9
01	1X	2X	3X	2, 4, 5, 7, 8, 9
1X	00	3X	1X	6
1X	01	3X	2X	6
1X	1X	3X	3X	6

The Clock Mode Register also contains the following bits:

- MCP (bit 4) determines which edge of the pixel clock output will be used to latch input data. Zero selects the negative edge, one selects the positive edge.
- M/S* (bit 6) determines whether the device operates in master or slave clock mode. In master mode (1), the 14.31818MHz clock is used as a frequency reference to the PLL. In slave mode (0) the XCLK input is used as a reference to the PLL, and is divided by the value specified by XCM[1:0]. The divide by N and M are forced to one.
- CFRB (bit 7) sets whether the chroma subcarrier free-runs, or is locked to the video signal. One causes the subcarrier to lock to the TV vertical rate, and should be used when the ACIV bit is set to zero. Zero causes the subcarrier to free-run, and should be used when the ACIV bit is set to one.

Start Active Video Register

Symbol: SAV
Address: 07H
Bits: 8

Bit:	7	6	5	4	3	2	1	0
Symbol:	SAV7	SAV6	SAV5	SAV4	SAV3	SAV2	SAV1	SAV0
Type:	R/W	R/W	R/W	R/W	R/W	R/W	R/W	R/W
Default:	0	0	0	0	0	0	0	0

This register sets the delay, in pixel increments, from leading edge of horizontal sync to start of active video. The entire bit field SAV[8:0] is comprised of this register SAV[7:0], plus the MSB value contained in the position overflow register, bit SAV8. This is decoded as a whole number of pixels, which can be set anywhere between 0 and 511 pixels. Therefore, in any 2X clock mode, the number of 2X clocks from the leading edge of sync to the first active data must be a multiple of two clocks. In any 3X clock mode, the number of 3X clocks from the leading edge of sync to the first active data must be a multiple of three clocks.

Register Descriptions (continued)

Position Overflow Register

Symbol: PO
Address: 08H
Bits: 3

Bit:	7	6	5	4	3	2	1	0
Symbol:						SAV8	HP8	VP8
Type:						R/W	R/W	R/W
Default:						0	0	0

This position overflow register contains the MSB values for the SAV, HP, and VP values, as follows:

- VP8 (bit 0) is the MSB of the vertical position value (see explanation under “Vertical Position Register”).
- HP8 (bit 1) is the MSB of the horizontal position value (see explanation under “Horizontal Position Register”).
- SAV8 (bit 2) is the MSB of the start of active video value (see explanation under “Start Active Video Register”).

Black Level Register

Symbol: BLR
Address: 09H
Bits: 8

Bit:	7	6	5	4	3	2	1	0
Symbol:	BL7	BL6	BL5	BL4	BL3	BL2	BL1	BL0
Type:	R/W	R/W	R/W	R/W	R/W	R/W	R/W	R/W
Default:	0	1	1	1	1	1	1	1

This register sets the black level. The luminance data is added to this black level, which must be set between 90 and 208, with the default value being 127. Recommended values for NTSC and PAL-M are 127, 105 for PAL and 100 for NTSC-J. This value must be set to zero when in SCART mode.

Horizontal Position Register

Symbol: HPR
Address: 0AH
Bits: 8

Bit:	7	6	5	4	3	2	1	0
Symbol:	HP7	HP6	HP5	HP4	HP3	HP2	HP1	HP0
Type:	R/W	R/W	R/W	R/W	R/W	R/W	R/W	R/W
Default:	0	0	0	0	0	0	0	0

The horizontal position register is used to shift the displayed TV image in a horizontal direction (left or right) to achieve a horizontally centered image on screen. The entire bit field, HP[8:0] is comprised of this register HP[7:0] plus the MSB value contained in the position overflow register, bit HP8. Increasing this value moves the displayed image position RIGHT; decreasing this value moves the displayed image position LEFT. Each increment moves the image position by 4 input pixels.

Register Descriptions (continued)

Vertical Position Register

Symbol: VPR
Address: 0BH
Bits: 8

Bit:	7	6	5	4	3	2	1	0
Symbol:	VP7	VP6	VP5	VP4	VP3	VP2	VP1	VP0
Type:	R/W	R/W	R/W	R/W	R/W	R/W	R/W	R/W
Default:	0	0	0	0	0	0	0	0

This register is used to shift the displayed TV image in a vertical direction (up or down) to achieve a vertically centered image on screen. This bit field, VP[8:0] represents the TV line number (relative to the VGA vertical sync) used to initiate the generation and insertion of the TV vertical interval (i.e., the first sequence of equalizing pulses). Increasing values delay the output of the TV vertical sync, causing the image position to move UP on the TV screen. Decreasing values, therefore, move the image position DOWN. Each increment moves the image position by one TV lines (approximately 4 input lines). The maximum value that should be programmed into the VP[8:0] value is the number of TV lines minus one, divided by two (262, 312 or 313). When panning the image up, the number should be increased until (TVLPF-1) /2 is reached; the next step should be to reset the register to zero. When panning the image down the screen, the VP[8:0] value should be decremented until the value zero is reached. The next step should set the register to (TVLPF-1) /2, and then decrementing can continue. If this value is programmed to a number greater than (TV lines per frame-1) /2, a TV vertical SYNC will not be generated.

Sync Polarity Register

Symbol: SPR
Address: 0DH
Bits: 4

Bit:	7	6	5	4	3	2	1	0
Symbol:					DES	SYO	VSP	HSP
Type:					R/W	R/W	R/W	R/W
Default:					0	0	0	0

This register provides selection of the synchronization signal input to, or output from, the CH7013A.

- HSP (bit 0) is Horizontal Sync Polarity - an HSP value of zero means the horizontal sync is active low, and a value of one means the horizontal sync is active high.
- VSP (bit 1) is Vertical Sync Polarity - a VSP value of zero means the vertical sync is active low, and a value of one means the vertical sync is active high.
- SYO (bit 2) is Sync Direction - a SYO value of zero means that H and V sync are input to the CH7013A. A value of one means that H and V sync are output from the CH7013A.
- DES (bit 3) is Detect Embedded Sync - a DES value of zero means that H and V sync will be obtained from the direct pin inputs. A DES value of one means that H and V sync will be detected from the embedded codes on the pixel input stream. Note that this will only be valid for the YCrCb input modes.

Note: When sync direction is set to be an output, horizontal sync will use a fixed pulse width of 64 pixels and vertical sync will use a fixed pulse width of 2 lines.

Register Descriptions (*continued*)

Power Management Register

Symbol: PMR

Address: 0EH

Bits: 5

Bit:	7	6	5	4	3	2	1	0
Symbol:				SCART	Reset*	PD2	PD1	PD0
Type:				R/W	R/W	R/W	R/W	R/W
Default:				0	1	0	1	1

This register provides control of the power management functions, a software reset (Reset*) and the SCART output enable. The CH7013A provides programmable control of its operating states, as described in the table below.

Table 23. Power Management

PD[2:0]	Operating State	Functional Description
000	Composite Off	CVBS DAC is powered down
001	Power Down	Most pins and circuitry are disabled (except for the buffered clock outputs which are limited to the 14MHz output and VCO divided outputs).
010	S-Video Off	S-Video DACs are powered down
011	Normal (On)	All circuits and pins are active.
1XX	Full Power Down	All circuitry is powered down, except serial port

Reset* (bit 3) is soft reset. Setting this bit will reset all circuitry requiring a power on reset, except for this bit itself and the serial port.

SCART (bit 4) is the SCART enable. Setting SCART = 0 means the CH7013A will operate normally, outputting Y/C and CVBS from the three DACs. SCART=1 enables SCART output, which will cause R, G and B to be output from the DACs and composite sync from the CSYNC pin.

Note: For complete details regarding the operation of these modes, see the *Power Management* in *Functional Description* sections.

Connection Detect Register

Symbol: CDR

Address: 10H

Bits: 4

Bit:	7	6	5	4	3	2	1	0
Symbol:					YT	CT	CVBST	SENSE
Type:					R	R	R	W
Default:					0	0	0	0

The Connection Detect Register provides a means to sense the connection of a TV to either S-Video or Composite video outputs. The status bits, YT, CT, and CVBST correspond to the DAC outputs for S-Video (Y and C outputs) and Composite video (CVBS), respectively. However, the values contained in these status bits are NOT VALID until a sensing procedure is performed. Use of this register requires a sequence of events to enable the sensing of outputs, then reading out the applicable status bits. The detection sequence works as follows:

1. Ensure the power management register Bits 2-0 are set to 011 (normal mode).

Register Descriptions (continued)

2. Set the SENSE bit to a 1. This forces a constant current output onto the Y, C, and CVBS outputs. Note that during SENSE = 1, these 3 analog outputs are at steady state and no TV synchronization pulses are asserted.
3. Reset the SENSE bit to 0. This triggers a comparison between the voltage sensed on these analog outputs and the reference value expected ($V_{\text{threshold}} = 1.235\text{V}$). If the measured voltage is below this threshold value, it is considered connected, if it is above this voltage it is considered unconnected. During this step, each of the three status bits corresponding to individual analog outputs will be set if they are NOT connected.
4. Read the status bits. The status bits, Y, C, and CVBST (corresponding to S-Video Y and C outputs and composite video) now contain valid information which can be read to determine which outputs are connected to a TV. Again, a “0” indicates a valid connection, a “1” indicates an unconnected output.

Contrast Enhancement Register

Symbol: CE
Address: 11H
Bits: 3

Bit:	7	6	5	4	3	2	1	0
Symbol:						CE2	CE1	CE0
Type:						R/W	R/W	R/W
Default:						0	1	1

This register provides control of the contrast enhancement feature of the CH7013A, according to the table below. At a setting of 000, the video signal will be pulled towards the maximum black level. As the value of CE[2:0] is increased, the amount that the signal is pulled towards black is decreased until unity gain is reached at a setting of 011. From this point on, the video signal is pulled towards the white direction, with the effect increasing with increasing settings of CE[2:0].

Table 24. Contrast Enhancement Function

CE[2:0]	Description (all gains limited to 0-255)
000	Contrast enhancement gain 3 $Y_{\text{out}} = (5/4)*(Y_{\text{in}}-102) = \text{Enhances Black}$
001	Contrast enhancement gain 2 $Y_{\text{out}} = (9/8)*(Y_{\text{in}}-57)$
010	Contrast enhancement gain 1 $Y_{\text{out}} = (17/16)*(Y_{\text{in}}-30)$
011	Normal mode $Y_{\text{out}} = (1/1)*(Y_{\text{in}}-0) = \text{Normal Contrast}$
100	Contrast enhancement gain 1 $Y_{\text{out}} = (17/16)*(Y_{\text{in}}-0)$
101	Contrast enhancement gain 2 $Y_{\text{out}} = (9/8)*(Y_{\text{in}}-0)$
110	Contrast enhancement gain 3 $Y_{\text{out}} = (5/4)*(Y_{\text{in}}-0)$
111	Contrast enhancement gain 4 $Y_{\text{out}} = (3/2)*(Y_{\text{in}}-0) = \text{Enhances White}$

Register Descriptions (*continued*)

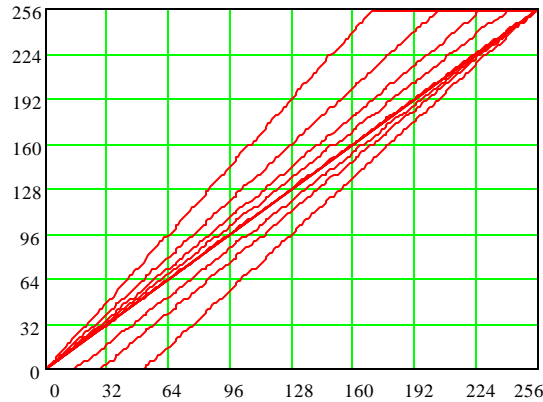

Figure 19: Luma Transfer Function at different contrast enhancement settings

PLL Overflow Register

Symbol: MNE
Address: 13H
Bits: 5

Bit:	7	6	5	4	3	2	1	0
Symbol:				Reserved	Reserved	N9	N8	M8
Type:				R/W	R/W	R/W	R/W	R/W
Default:				0	0	0	0	0

The PLL Overflow Register contains the MSB bits for the ‘M’ and ‘N’ vlaues, which will be described in the PLL-M and PLL-N registers, respectively. The reserved bits should not be written to.

PLL M Value Register

Symbol: PLLM
Address: 14H
Bits: 8

Bit:	7	6	5	4	3	2	1	0
Symbol:	M7	M6	M5	M4	M3	M2	M1	M0
Type:	R/W	R/W	R/W	R/W	R/W	R/W	R/W	R/W
Default:	0	1	0	0	0	0	0	1

The PLL M value register determines the division factor applied to the frequency reference clock before it is input to the PLL phase detector when the CH7013A is operating in master or pseudo-master clock mode. In slave mode, an external pixel clock is used instead of the frequency reference, and the division factor is determined by the XCM[3:0] value. This register contains the lower 8 bits of the complete 9-bit M value.

Register Descriptions (continued)

PLL N Value Register

Symbol: PLLN

Address: 15H

Bits: 8

Bit:	7	6	5	4	3	2	1	0
Symbol:	N7	N6	N5	N4	N3	N2	N1	N0
Type:	R/W	R/W	R/W	R/W	R/W	R/W	R/W	R/W
Default:	1	0	0	0	0	0	0	0

The PLL N value register determines the division factor applied to the VCO output before being applied to the PLL phase detector, when the CH7013A is operating in master or pseudo-master mode. In slave mode, the value of ‘N’ is always 1. This register contains the lower 8 bits of the complete 10-bit N value. The pixel clock generated in a master and pseudo-master modes is calculated according to the equation below:

$$F_{\text{pixel}} = F_{\text{ref}} * [(N+2) / (M+2)]$$

When using a 14.318 MHz frequency reference, the required M and N values for each mode are shown in the table below.

Table 25. M and N Values for Each Mode

Mode	VGA Resolution, TV Standard, Scaling Ratio	N 10-bits	M 9-bits	Mode	VGA Resolution, TV Standard, Scaling Ratio	N 10-bits	M 9-bits
0	512x384, PAL, 5:4	20	13	15	640X480, PAL, 5:6	9	3
1	512x384, PAL, 1:1	9	4	16	640X480, NTSC, 1:1	110	63
2	512X384, NTSC, 5:4	126	89	17	640X480, NTSC, 7:8	126	63
3	512X384, NTSC, 1:1	110	63	18	640X480, NTSC, 5:6	190	89
4	720X400, PAL, 5:4	53	26	19	800X600, PAL, 1:1	647	313
5	720X400, PAL, 1:1	339	138	20	800X600, PAL, 5:6	86	33
6	720X400, NTSC, 5:4	106	63	21	800X600, PAL, 3:4	284	103
7	720X400, NTSC, 1:1	70	33	22	800X600, NTSC, 5:6	94	33
8	640X400, PAL, 5:4	108	61	23	800X600, NTSC, 3:4	62	19
9	640X400, PAL, 1:1	9	3	24	800X600, NTSC, 7:10	302	89
10	640X400, NTSC, 5:4	94	63	25	720X576, PAL, 1:1	31	33
11	640x400, NTSC, 1:1	22	11	26	720X480, NTSC, 1:1	31	33
12	640X400, NTSC, 7:8	190	89	27	800X500, PAL, 1:1	242	197
13	640X480, PAL, 5:4	20	13	28	640X400, NTSC, 1:1	2	2
14	640X480, PAL, 1:1	9	4				

Buffered Clock Output Register

Symbol: BCO

Address: 17H

Bits: 6

Bit:	7	6	5	4	3	2	1	0
Symbol:			SHF2	SHF1	SHF0	SCO2	SCO1	SCO0
Type:			R/W	R/W	R/W	R/W	R/W	R/W
Default:			0	0	0	0	0	0

The buffered clock output register determines which clock is selected to be output at the buffered clock output pin, and what frequency value should be output if a VCO derived signal is output. The tables below show the possible outputs signals.

Register Descriptions (continued)

Table 26. Clock Output Selection

SCO[2:0]	Buffered Clock Output
000	14MHz crystal
001	(for test use only)
010	VCO divided by K3 (see Table27)
011	Field ID signal
100	(for test use only)
101	(for test use only)
110	TV horizontal sync (for test use only)
111	TV vertical sync (for test use only)

Table 27. K3 Selection

SHF[2:0]	K3
000	2.5
001	3
010	3.5
011	4
100	4.5
101	5
110	6
111	7

Sub-carrier Value Registers

Symbol: FSCI
Address: 18H - 1FH
Bits: 4 or 8 each

Bit:	7	6	5	4	3	2	1	0
Symbol:					FSCI#	FSCI#	FSCI#	FSCI#
Type:					R/W	R/W	R/W	R/W
Default:								

The lower four bits of registers 18H through 1FH contain a 32-bit value which is used as an increment value for the ROM address generation circuitry. The bit locations are specified as the following:

<u>Register</u>	<u>Contents</u>
18H	FSCI[31:28]
19H	FSCI[27:24]
1AH	FSCI[23:20]
1BH	FSCI[19:16]
1CH	FSCI[15:12]
1DH	FSCI[11:8]
1EH	FSCI[7:4]
1FH	FSCI[3:0]

Register Descriptions (continued)

When the CH7013A is operating in the master clock mode, the tables below should be used to set the FSCI registers. When using these values, the ACIV bit in register 21H should be set to “0”, and the CFRB bit in register 06H should be set to “1”.

Table 28. FSCI Values (525-Line Modes)

Mode	NTSC “Normal Dot Crawl”	NTSC “No Dot Crawl”	PAL-M “Normal Dot Crawl”
2	763,363,328	763,366,524	762,524,467
3	623,153,737	623,156,346	622,468,953
6	574,429,782	574,432,187	573,798,541
7	463,962,517	463,964,459	463,452,668
10	646,233,505	646,236,211	645,523,358
11	516,986,804	516,988,968	516,418,687
12	452,363,454	452,365,347	451,866,351
16	623,153,737	623,156,346	622,468,953
17	545,259,520	545,261,803	544,660,334
18	508,908,885	508,911,016	508,349,645
22	521,957,831	521,960,016	521,384,251
23	469,762,048	469,764,015	469,245,826
24	428,554,851	428,556,645	428,083,911
26	569,408,543	569,410,927	568,782,819
28	1,073,741,824	1,073,746,319	1,072,561,888

Table 29. FSCI Values (625-Line Modes)

Mode	PAL “Normal Dot Crawl”	PAL-N “Normal Dot Crawl”
0	806,021,060	651,209,077
1	644,816,848	520,967,262
4	601,829,058	486,236,111
5	485,346,014	392,125,896
8	677,057,690	547,015,625
9	537,347,373	434,139,385
13	806,021,060	651,209,077
14	644,816,848	520,967,262
15	537,347,373	434,139,385
19	645,499,916	521,519,134
20	528,951,320	427,355,957
21	488,262,757*	394,482,422
25	705,268,427	569,807,942
27	1,073,747,879	867,513,766

When the CH7007 is operating in the slave clock mode, the ACIV bit in register 21H should be set to “1” and the CFRB bit in register 06H should be set to “0”.

***Note:** For reduced cross-color and cross-luminance artifacts, a value of 488,265,597 can be used with CFRB = “0” & ACIV = “0”.

Register Descriptions (continued)

PLL Control Register

Symbol: PLLC

Address: 20H

Bits: 6

Bit:	7	6	5	4	3	2	1	0
Symbol:			PLLCPI	PLLCAP	PLLS	PLL5VD	PLL5VA	MEM5V
Type:			R/W	R/W	R/W	R/W	R/W	R/W
Default:			0	0	1	0	1	0

The following PLL and memory controls are available through the PLL control register:

- MEM5V MEM5V is set to 1 when the memory supply is 5 volts. The default value of 0 is used when the memory supply is 3.3 volts.
- PLL5VA PLL5VA is set to 1 when the phase-locked loop analog supply is 5 volts (default). A value of 0 is used when the phase-locked loop analog supply is 3.3 volts.
- PLL5VD PLL5VD is set to 1 when the phase-locked loop digital supply is 5 volts. A value of 0 is used when the phase-locked loop digital supply is 3.3 volts (default).
- PLLS PLLS controls the number of stages used in the PLL. When the PLL5VA is 1 (5V analog PLL supply) PLLS should be 1, and seven stages are used. When PLL5VA is 0 (3.3V analog PLL supply) PLLS should be 0, and five stages are used.
- PLLCAP PLLCAP controls the loop filter capacitor of the PLL. A recommended listing of PLLCAP vs. Mode is shown below
- PLLCPI PLLCHI controls the charge pump current of the PLL. The default value should be used.

Register Descriptions (continued)

Table 30. PLL Capacitor Setting

Mode	PLLCAP Value
0	1
1	1
2	1
3	0
4	1
5	0
6	1
7	1
8	0
9	1
10	1
11	1
12	0
13	1
14	1
15	1
16	0
17	0
18	0
19	0
20	1
21	0
22	1
23	1
24	0
25	1
26	1
27	0
28	1

Register Descriptions (continued)

CIV Control Register

Symbol: CIVC
Address: 21H
Bits: 5

Bit:	7	6	5	4	3	2	1	0
Symbol:				CIV25	CIV24	CIVH1	CIVH0	ACIV
Type:				R	R	R/W	R/W	R/W
Default:				0	0	0	0	1

The following controls are available through the CIV control register:

- ACIV When the automatic calculated increment value is 1, the number calculated and present at the CIV registers will automatically be used as the increment value for subcarrier generation, removing the need for the user to read the CIV value and write in a new FSCI value. Whenever this bit is set to 1, the subcarrier generation must be forced to free-run mode.
- CIVH[1:0] These bits control the hysteresis circuit which is used to calculate the CIV value.
- CIV[25:24] See descriptions in the next section.

Calculated Increment Value Register

Symbol: CIV
Address: 22H - 24H
Bits: 8

Bit:	7	6	5	4	3	2	1	0
Symbol:	CIV#	CIV#	CIV#	CIV#	CIV#	CIV#	CIV#	CIV#
Type:	R	R	R	R	R	R	R	R
Default:	0	0	0	0	0	0	0	0

The CIV registers 22H through 24H contain a 26-bit value, which is the calculated increment value that should be used as the upper 26 bits of FSCI. This value is determined by a comparison of the pixel clock and the 14MHz clock. The bit locations and calculation of CIV are specified as the following:

Register	Contents
21H	CIV[25:24]
22H	CIV[23:16]
23H	CIV[15:8]
24H	CIV[7:0]

Register (Continued)

Version ID Register

Symbol: VID
Address: 25H
Bits: 8

Bit:	7	6	5	4	3	2	1	0
Symbol:	VID7	VID6	VID5	VID4	VID3	VID2	VID1	VID0
Type:	R	R	R	R	R	R	R	R
Default:	0	0	1	1	0	0	1	0

This read-only register contains a 8-bit value indicating the identification number assigned to this version of the CH7013A. The default value shown is pre-programmed into this chip and is useful for checking for the correct version of this chip, before proceeding with its programming.

Address Register

Symbol: AR
Address: 3FH
Bits: 6

Bit:	7	6	5	4	3	2	1	0
Symbol:			AR5	AR4	AR3	AR2	AR1	AR0
Type:			R/W	R/W	R/W	R/W	R/W	R/W
Default:			X	X	X	X	X	X

The Address Register points to the register currently being accessed.

Electrical Specifications

Table 31. Absolute Maximum Ratings

Symbol	Description	Min	Typ	Max	Units
	V _{DD} relative to GND	- 0.5		7.0	V
	Input voltage of all digital pins ¹	GND - 0.5		V _{DD} + 0.5	V
T _{SC}	Analog output short circuit duration		Indefinite		Sec
T _{AMB}	Ambient operating temperature	- 55		85	°C
T _{STOR}	Storage temperature	- 65		150	°C
T _J	Junction temperature			150	°C
T _{VPS}	Vapor phase soldering (one minute)			220	°C
P _{MAX}	Maximum power dissipation			1.9	W

Notes:

- 1 Stresses greater than those listed under absolute maximum ratings may cause permanent damage to the device. These are stress ratings only. Functional operation of the device at these or any other conditions above those indicated under the normal operating condition of this specification is not recommended. Exposure to absolute maximum rating conditions for extended periods may affect reliability.
- 2 The device is fabricated using high-performance CMOS technology. It should be handled as an ESD-sensitive device. Voltage on any signal pin that exceeds the power supply voltage by more than +0.5V can induce destructive latch.

Electrical Specifications (Continued)

Table 32. Recommended Operating Conditions

Symbol	Description	Min	Typ	Max	Units
V _{DD}	DAC power supply voltage	4.75	5.00	5.25	V
AVDD	Analog supply voltage	4.75	5.00	5.25	
DVDD	Digital supply voltage	3.0	3.3	3.6	
TA	Ambient operating temperature	0	25	70	°C
R _L	Output load to DAC outputs		37.5		Ω

Table 33. Electrical Characteristics (Operating Conditions: T_A = 0°C - 70°C, V_{DD} = 5V ± 5%)

Symbol	Description	Min	Typ	Max	Unit
	Video D/A resolution	9	9	9	Bits
	Full scale output current		33.89		mA
	Video level error			10	%
	VDD & AVDD current (5.V)(Simultaneous S-Video & composite outputs)		105		mA
	DVDD current (3.3V)		40		mA

Note: As applied to **Tables 32, 33 and 34**, Recommended Operating Conditions are used as test conditions unless otherwise specified. External voltage reference used with RSET = 360 Ω, VREF = 1.235V, and NTSC CCIR601 operation.

Table 34. Timing - TV Encoder

Symbol	Description	Min	Typ	Max	Unit
t _{P1}	Pixel Clock Period	20		50	nS
t _{PH1}	Pixel Clock High Time	8		25	nS
tdc1	Pixel Clock Duty Cycle (t _{PH1} /t _{P1})	40	50	60	%
t _{P2}	Pixel Clock Period	10		25	nS
t _{PH2}	Pixel Clock High Time				nS
tdc2	Pixel Clock Duty Cycle (t _{PH2} /t _{P2})	40	50	60	%
t _{P3}	Pixel Clock Period	10		17	nS
t _{PH3}	Pixel Clock High Time				nS
tdc3	Pixel Clock Duty Cycle (t _{PH3} /t _{P3})	40	50	60	%

Table 35. Digital Inputs / Outputs

Symbol	Description	Test Condition	Min	Typ	Max	Unit
V _{SPOL}	DATA Output Low Voltage	IOL = 3.2 mA			0.4	V
V _{SPIH}	DATA Input High Voltage		3.4		VDD + 0.5	V
V _{SPIL}	DATA Input Low Voltage		GND-0.5		1.4	V
V _{DATAIH}	D[0-15] Input High Voltage		2.5		DVDD+0.5	V
V _{DATAIL}	D[0-15] Input Low Voltage		GND-0.5		0.8	V
V _{P-OUTOH}	P-OUT Output High Voltage	IOL = -400 μA	2.8			V
V _{P-OUTOL}	P-OUT Output Low Voltage	IOL = 3.2 mA			0.2	V

- Note:**
1. V_{SP} - refers to serial port pins DATA and CLOCK.
 2. V_{DATA} - refers to all digital pixel and clock inputs.
 3. V_{P-OUT} - refers to pixel data output. Time - Graphics

Table 36. Timing -Graphics

Symbol	Description	Min	Typ	Max	Unit
t _{HSW}	Horizontal Sync Pulse Width	1			t _p
t _{HD}	Pixel Clock to Horizontal Leading Edge Delay	2		17	nS
t _{SP1} , t _{SP2} , t _{SP3}	Setup time from Pixel Data to Pixel Clock	2			nS
t _{PH1} , t _{HP2} , t _{PH3}	Hold time from Pixel Clock to Pixel Data	2			nS

ORDERING INFORMATION			
Part number	Package type	Number of pins	Voltage supply
CH7013A-V	PLCC	44	3V/5V
CH7013A-T	TQFP	44	3V/5V

Chrontel

2210 O'Toole Avenue
San Jose, CA 95131-1326
Tel: (408) 383-9328
Fax: (408) 383-9338
www.chrontel.com
E-mail: sales@chrontel.com

©1998 Chrontel, Inc. All Rights Reserved.

Chrontel PRODUCTS ARE NOT AUTHORIZED FOR AND SHOULD NOT BE USED WITHIN LIFE SUPPORT SYSTEMS OR NUCLEAR FACILITY APPLICATIONS WITHOUT THE SPECIFIC WRITTEN CONSENT OF Chrontel. Life support systems are those intended to support or sustain life and whose failure to perform when used as directed can reasonably expect to result in personal injury or death. Chrontel reserves the right to make changes at any time without notice to improve and supply the best possible product and is not responsible and does not assume any liability for misapplication or use outside the limits specified in this document. We provide no warranty for the use of our products and assume no liability for errors contained in this document. Printed in the U.S.A.