

FEATURES

- WIDE BAND OPERATION UP TO 2.5 GHz
- LOW VOLTAGE OPERATION: 2.7 V Minimum
- LOW POWER CONSUMPTION: 15 mW (UPC2757T)
- POWER SAVE FUNCTION
- SUPER SMALL PACKAGE
- TAPE AND REEL PACKAGING OPTION AVAILABLE

DESCRIPTION

The UPC2757T and UPC2758T are L-Band Frequency Converters manufactured using the NESAT III MMIC process. These products consist of a double balanced mixer, IF amplifier and LO buffer amplifier. The UPC2757T is designed for low power consumption while the UPC2758T is designed for low distortion. Both devices operate on a 3 volt supply voltage making them ideal for portable hand held cellular, GPS, PCN and wireless LAN applications.

NEC's stringent quality assurance and test procedures ensure the highest reliability and performance.

CONVERSION GAIN vs. LO FREQUENCY
V_{CC} = 3 V, LO Power = -5 dBm
RF Above LO

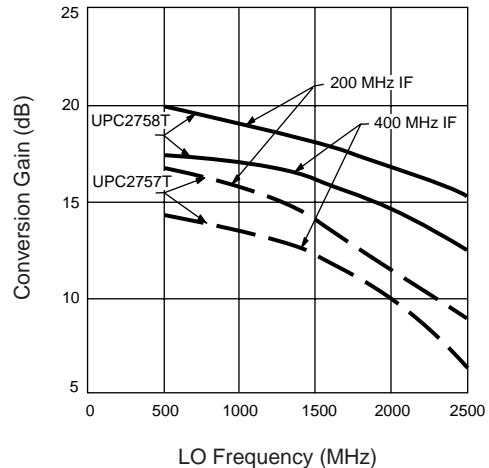

ELECTRICAL CHARACTERISTICS (T_A = 25°C, V_{CC} = 3 V, V_{PS} = 3 V, P_{LO} = -10 dBm)

PART NUMBER PACKAGE OUTLINE			UPC2757T T06			UPC2758T T06		
SYMBOLS	PARAMETERS AND CONDITIONS	UNITS	MIN	TYP	MAX	MIN	TYP	MAX
I _{CC}	Circuit Current, V _{PS} = 3 V V _{PS} = 0.5 V	mA μA	3.7	5.6 0.1	7.7	6.6	11 0.1	14.8
f _{RF}	RF Operating Frequency Range (The conversion gain at f _{RF} is not more than 3 dB down from the gain at f _{RF} = 800 MHz, f _{IF} = 130 MHz)	GHz	0.1		2.0	0.1		2.0
f _{IF}	IF Operating Frequency Range (The conversion gain at f _{IF} is not more than 3 dB down from the gain at f _{RF} = 800 MHz, f _{IF} = 130 MHz)	MHz	20		300	20		300
CG	Conversion Gain ¹ , f _{RF} = 800 MHz, f _{IF} = 130 MHz f _{RF} = 2.0 GHz, f _{IF} = 250 MHz	dB dB	12 10	15 13	18 16	16 14	19 17	22 20
NF	Noise Figure, f _{RF} = 800 MHz, f _{IF} = 130 MHz f _{RF} = 2.0 GHz, f _{IF} = 250 MHz	dB dB		10 13	13 16		9 13	12 15
PSAT	Saturated Output Power ² , f _{RF} = 800 MHz, f _{IF} = 100 MHz	dBm		-3			+1	
P _{1dB}	Output Power at 1dB compression point, f _{RF} = 800 MHz f _{IF} = 100 MHz	dBm		-8			-3.5	
OIP ₃	Output 3rd Order Intercept Point, (SSB) P _{LO} = -10 dBm f _{RF} = 0.8~2.0 GHz, f _{IF} = 100 MHz	dBm		0			5	
ISO	LO Leakage, f _{LO} = 0.8 ~2.0 GHz	at RF pin dBm at IF pin dBm		-35 -23			-30 -15	
R _{TH} (J-A)	Thermal Resistance (Junction to Ambient) Free Air Mounted on a 50 x 50 x 1.6 mm epoxy glass PWB	°C/W °C/W			620 230			620 230

Notes:

1. P_{RF} = -40 dBm.
2. P_{RF} = -10 dBm.

UPC2757T, UPC2758T

ABSOLUTE MAXIMUM RATINGS¹ (T_A = 25°C)

SYMBOLS	PARAMETERS	UNITS	RATINGS
V _{CC} , V _{PS}	Supply Voltage	V	5.5
P _T	Total Power Dissipation ²	mW	280
T _{OP}	Operating Temperature	°C	-40 to +85
T _{STG}	Storage Temperature	°C	-55 to +150

Notes:

1. Operation in excess of any one of these parameters may result in permanent damage.
2. Mounted on a 50 x 50 x 1.6 mm epoxy glass PWB (T_A = +85°C).

RECOMMENDED OPERATING CONDITIONS

SYMBOLS	PARAMETERS	UNITS	MIN	TYP	MAX
V _{CC}	Supply Voltage	V	2.7	3.0	3.3
T _{OP}	Operating Temperature	°C	-40	+25	+85
P _{LO}	LO Input Level	dBm	-15	-10	-5

TYPICAL PERFORMANCE CURVES (T_A = 25°C)

UPC2758T
CONVERSION GAIN vs. LO FREQUENCY
 V_{CC} = 3 V, LO Power = -5 dBm
 RF Above LO

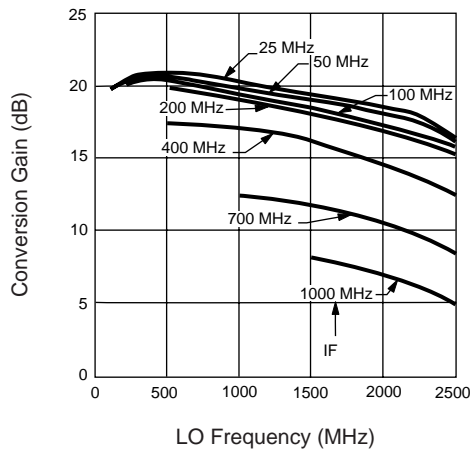

UPC2758T
OUTPUT POWER vs. IF FREQUENCY
 V_{CC} = 3 V, LO Power = -5 dBm
 RF Above LO

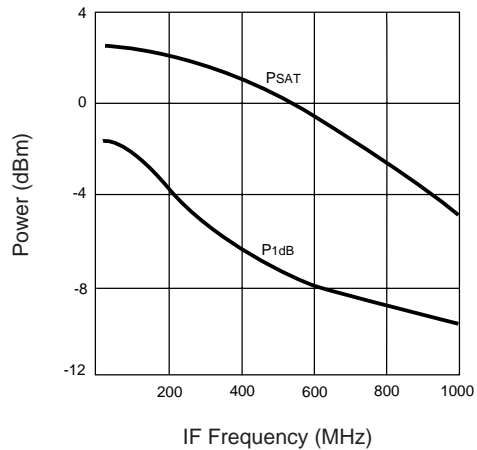

UPC2758T
LO TO IF ISOLATION vs. LO FREQUENCY
 V_{CC} = 3 V

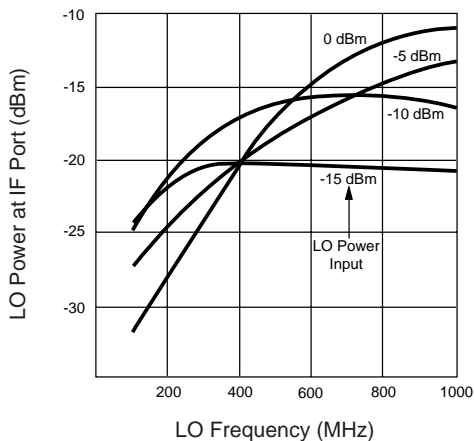

UPC2758T
UP-CONVERSION GAIN vs. LO FREQUENCY
 V_{CC} = 3 V, LO Power = -5 dBm
 Input Above LO

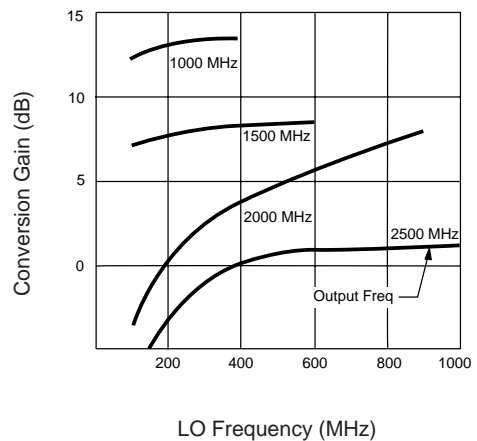

TEST CIRCUIT/BLOCK DIAGRAM

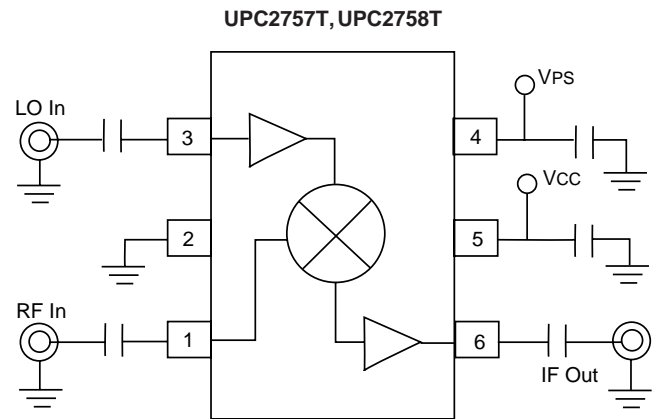

All Capacitors 0.1 μF

TYPICAL PERFORMANCE CURVES (T_A = 25°C)

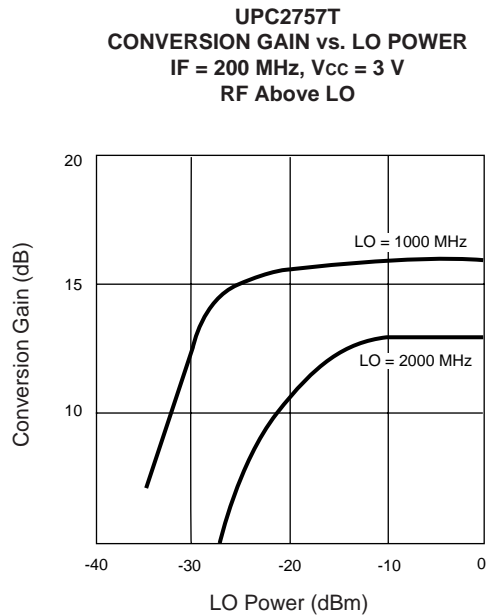
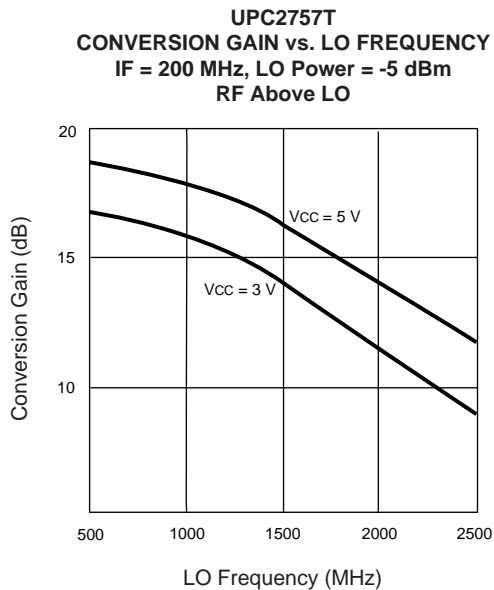
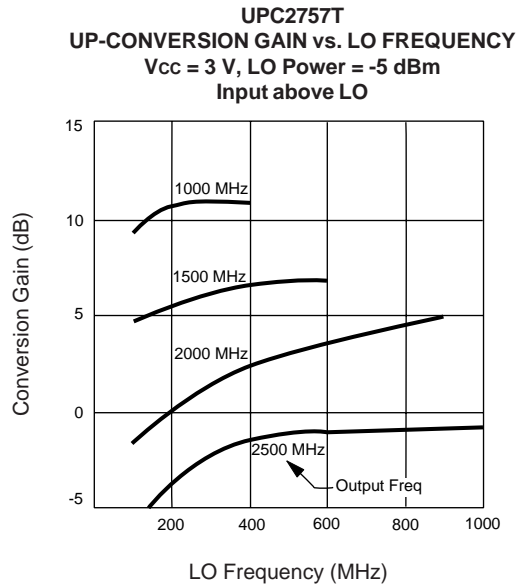
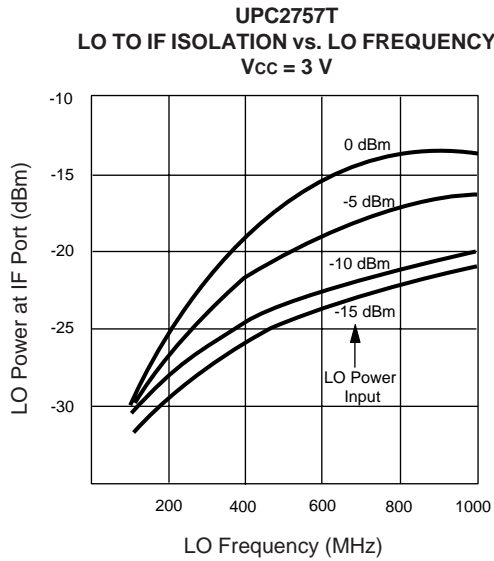
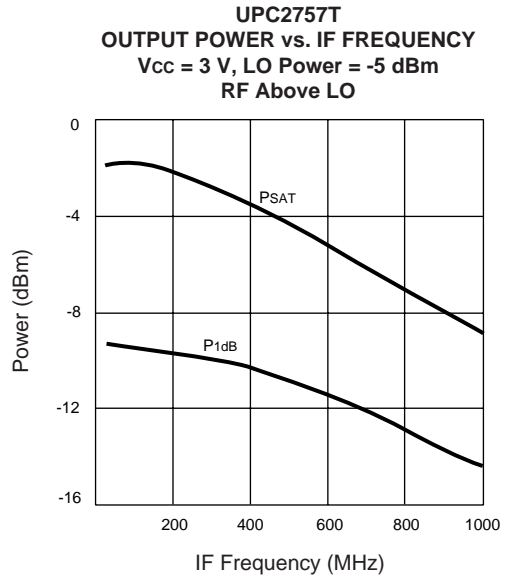
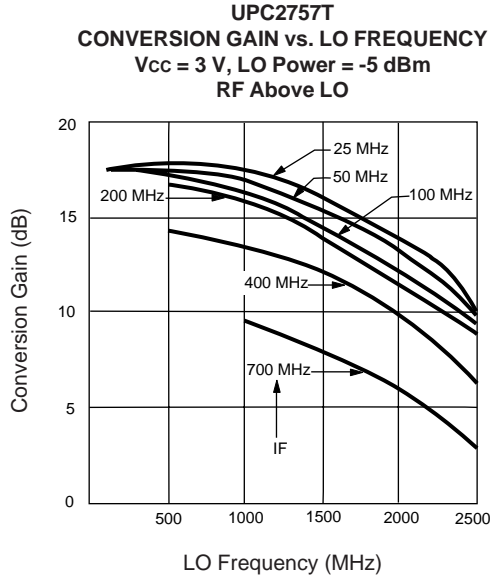

UPC2757T AND UPC2758T PORT IMPEDANCES

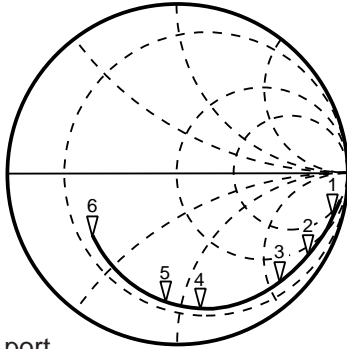

RF port and LO port
VCC = 3.0 V

1: 100 MHz	330.7 Ω - j861.6 Ω
2: 500 MHz	38.8 Ω - j194.3 Ω
3: 900 MHz	25.5 Ω - j107.6 Ω
4: 1500 MHz	20.5 Ω - j60.7 Ω
5: 1900 MHz	17.9 Ω - j44.2 Ω
6: 3000 MHz	19.5 Ω - j16.3 Ω

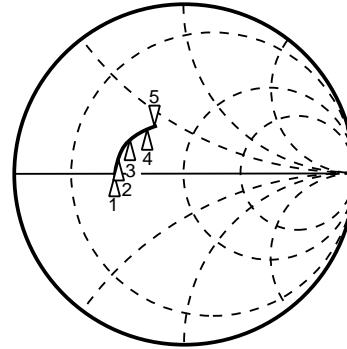

IF port
VCC = 3.0 V

1: 50 MHz	21.4 Ω + j2.4 Ω
2: 80 MHz	21.8 Ω + j5.5 Ω
3: 130 MHz	23.1 Ω + j9.4 Ω
4: 240 MHz	27.4 Ω + j16.3 Ω
5: 300 MHz	30.6 Ω + j19.1 Ω

OUTLINE DIMENSIONS (Units in mm)

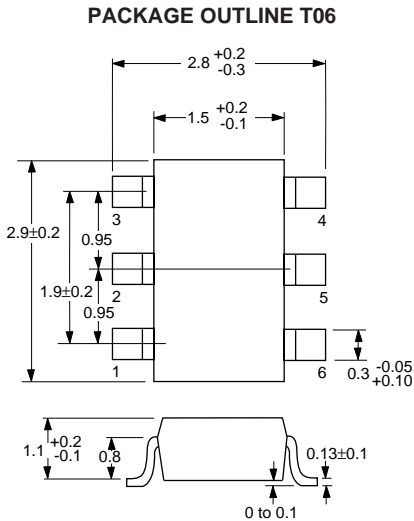

Note:
All dimensions are typical unless otherwise specified.

ORDERING INFORMATION

PART NUMBER	QTY
UPC2757T-E3	3K/Reel
UPC2758T-E3	3K/Reel

Note:
Embossed Tape, 8 mm wide,
Pins 1, 2, 3 are in tape pull-out direction.

RECOMMENDED P.C.B. LAYOUT (Units in mm)

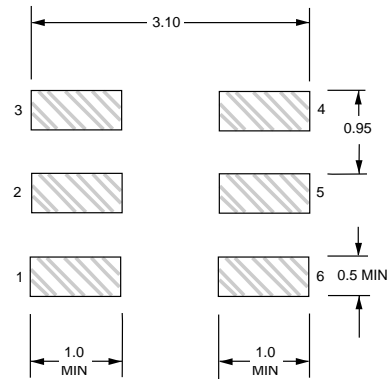

LEAD CONNECTIONS

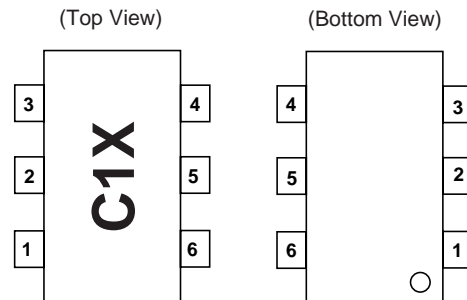

- 1. RF INPUT
- 2. GND
- 3. LO INPUT
- 4. PS
- 5. Vcc
- 6. IF OUTPUT

Note:
Package Markings:
C1X: UPC2757T
C1Y: UPC2758T