

1 550 nm CW LIGHT SOURCE
InGaAsP MQW-DFB LASER DIODE MODULE
WITH WAVELENGTH MONITOR**DESCRIPTION**

The NX8570 Series is a 1 550 nm Multiple Quantum Well (MQW) structured Distributed Feed-Back (DFB) laser diode module with wavelength monitor function. This device is temperature tunable over 4×50 GHz channels. Available at both C-band (1530.334 to 1565.087 nm) and L-band (1565.496 to 1608.760 nm) ITU-T grid wavelengths.

This device is designed as CW light source and ideal for transmission systems in which external modulators are used.

FEATURES

- Wavelength monitor function (Etalon Filter, Wavelength monitor PD)
- Optical output power: $P_r = 20$ mW MIN.
- Available for DWDM wavelengths based on ITU-T recommendations (50 GHz grid)
- 4-channel wavelength tunable capability for 50 GHz-spacing (NX8570S××××D)
- Internal thermo-electric cooler and isolator
- Hermetically sealed 14-pin butterfly package
- Polarization maintain fiber pigtail

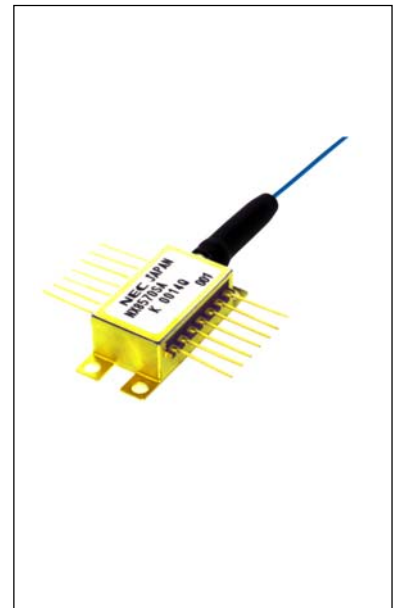

The information in this document is subject to change without notice. Before using this document, please confirm that this is the latest version.

★ PACKAGE DIMENSIONS (UNIT: mm)

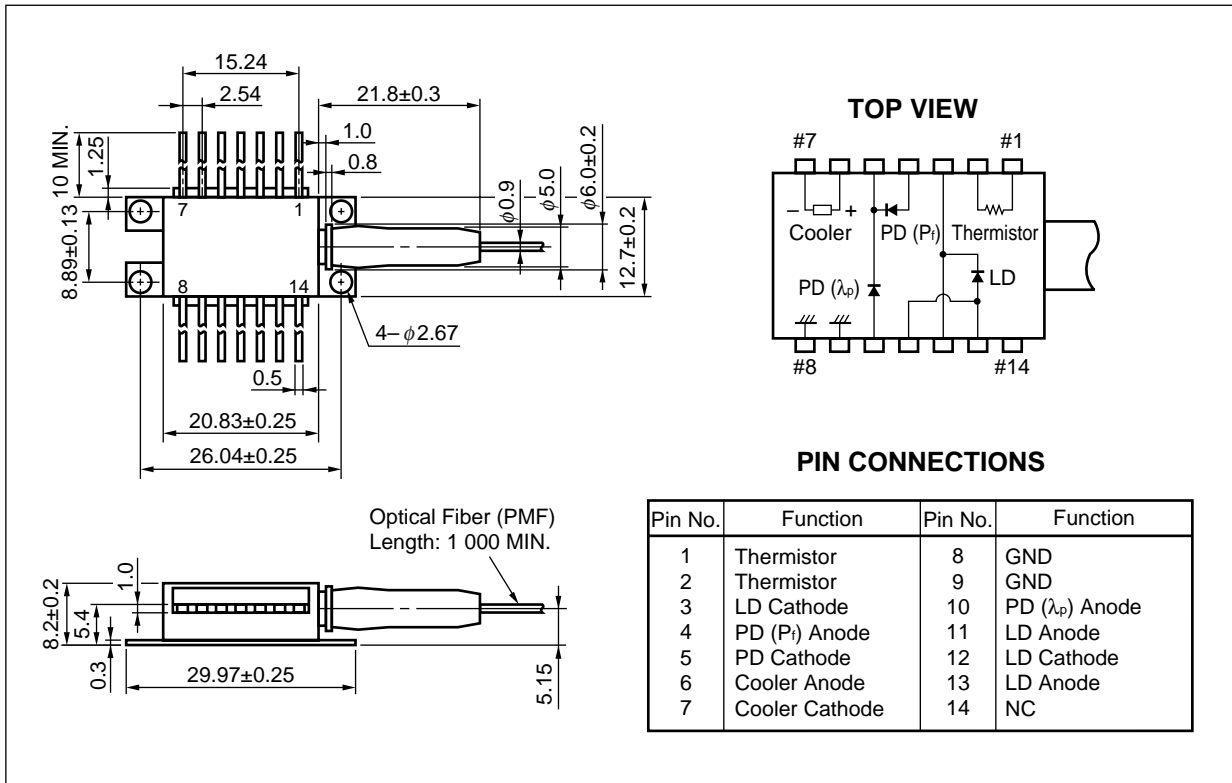

OPTICAL FIBER CHARACTERISTICS

Parameter	Specification	Unit
Outer Diameter	0.9±0.1	mm
Minimum Fiber Bending Radius	25	mm
Fiber Length	1 000 MIN.	mm

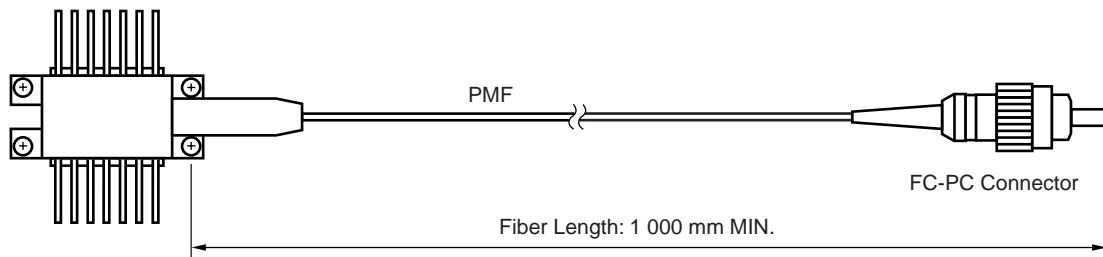

ABSOLUTE MAXIMUM RATINGS

Parameter	Symbol	Ratings	Unit
Forward Current of LD	I_F	300	mA
Reverse Voltage of LD	V_R	2.0	V
Forward Current of PD	I_F	10	mA
Reverse Voltage of PD	V_R	20	V
Operating Case Temperature	T_C	-20 to +70	°C
Storage Temperature	T_{stg}	-40 to +85	°C
Lead Soldering Temperature	T_{sld}	260 (10 sec.)	°C

ELECTRO-OPTICAL CHARACTERISTICS ($T_{LD} = T_{set}$, $T_C = -5$ to $+70^\circ\text{C}$, unless otherwise specified)

Parameter	Symbol	Conditions	MIN.	TYP.	MAX.	Unit
Laser Set Temperature	T_{set}	Single channel	20		35	°C
		4 channel tunable	10		45	
Forward Voltage	V_F	$P_f = 20$ mW	0.9	1.2	2.5	V
Threshold Current	I_{th}			20	40	mA
Operation Current	I_{op}	$P_f = 20$ mW		120	167	mA
Optical Output Power from Fiber	P_f	$I_f = 167$ mA, $T_{LD} = T_{set}$	20			mW
Peak Emission Wavelength	λ_p	$P_f = 20$ mW, CW, $T_{LD} = T_{set}$	1 530	ITU-T*1	1 609	nm
Wavelength Stability	-	$T_{LD} = T_{set}$, applicable to wavelength monitor, E.O.L	-20		+20	pm
Spectral Line Width	$\Delta\nu$	$P_f = 20$ mW, CW, 3 dB down		1	2	MHz
Side Mode Suppression Ratio	SMSR	$P_f = 20$ mW, CW	35	45		dB
Relative Intensity Noise	RIN	$P_f = 20$ mW, 20 MHz to 3 GHz			-150	dB/Hz
Optical Isolation	I_s	$P_f = 20$ mW, CW	30			dB
Polarization Extinction Ratio*2	ext	$P_f = 20$ mW, CW	20			dB

*1 Available for DWDM wavelengths based on ITU-T recommendations (50 GHz grid).

Please refer to **Table A**.

*2 Polarization state of LD is aligned parallel to the slow axis.

ELECTRO-OPTICAL CHARACTERISTICS (Applicable to Monitor PD: T_{LD} = T_{set}, T_c = -5 to +70°C)

Parameter	Symbol	Conditions	MIN.	TYP.	MAX.	Unit
Monitor Current (P _f Monitor)	I _m (P _f)	P _f = 20 mW, V _R = 5 V	30		300	μA
Monitor Current (λ _p Monitor)	I _m (λ _p)	P _f = 20 mW, V _R = 5 V, Locking point	15		150	μA
Operation Region*1	I _m (λ)		25		75	%
	λ ₁ -λ ₂		90			pm
Discrimination Slope*1	η _λ		0.05			μA/pm
Dark Current	I _D	V _R = 5 V		2	10	nA
Tracking Error	γ*2	I _m = const.			0.5	dB

*1 Operation region, Discrimination slope, Slope assignment

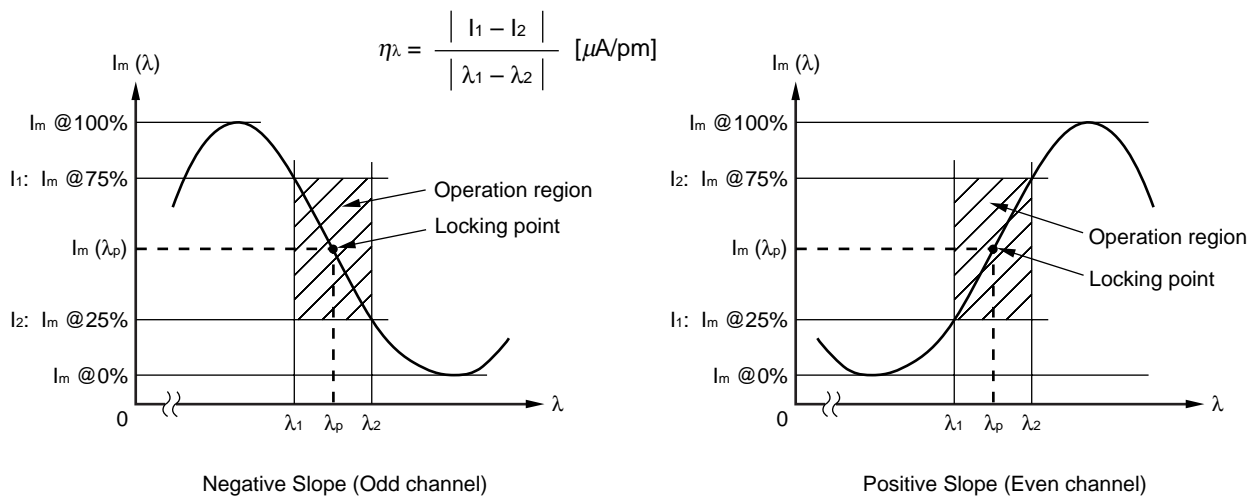

*2 Tracking Error: γ

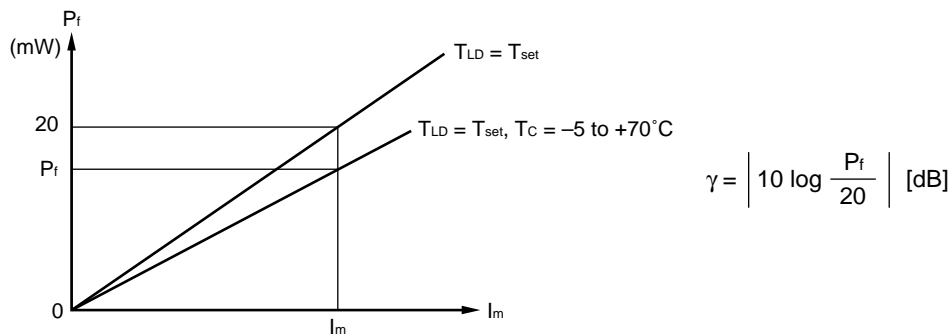

ELECTRO-OPTICAL CHARACTERISTICS (Applicable to Thermistor and TEC: T_{LD} = T_{set}, T_c = -5 to +70°C)

Parameter	Symbol	Conditions	MIN.	TYP.	MAX.	Unit
Thermistor Resistance	R	T _{LD} = 25°C	9.5	10.0	10.5	kΩ
B Constant	B	T _{LD} = 25°C	3 350	3 450	3 550	K
Cooler Current	I _c	ΔT = 70 - T _{set} , P _f = 20 mW			1.5	A
Cooler Voltage	V _c	ΔT = 70 - T _{set} , P _f = 20 mW			3.0	V

★ ORDERING INFORMATION

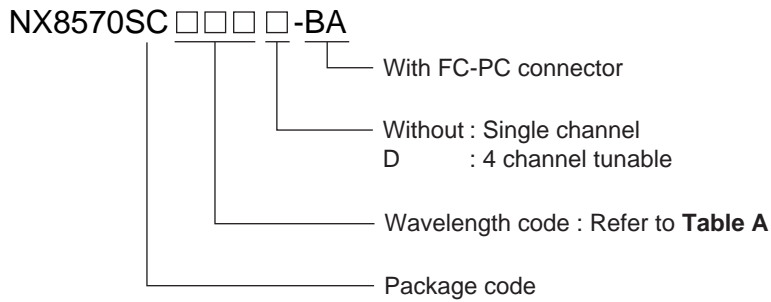

Table A: DWDM wavelength base on ITU-T recommendations (@ T_{LD} = T_{set}) (1/7)

Wavelength Code		ITU-T Wavelength *1 (nm)	Frequency (THz)	Monitor Slope
4 channel tunable	single channel			
315D	303	1530.33	195.90	Negative
	307	1530.72	195.85	Positive
	311	1531.11	195.80	Negative
	315	1531.50	195.75	Positive
330D	318	1531.89	195.70	Negative
	322	1532.29	195.65	Positive
	326	1532.68	195.60	Negative
	330	1533.07	195.55	Positive
346D	334	1533.46	195.50	Negative
	338	1533.85	195.45	Positive
	342	1534.25	195.40	Negative
	346	1534.64	195.35	Positive
362D	350	1535.03	195.30	Negative
	354	1535.42	195.25	Positive
	358	1535.82	195.20	Negative
	362	1536.21	195.15	Positive
377D	366	1536.60	195.10	Negative
	370	1537.00	195.05	Positive
	373	1537.39	195.00	Negative
	377	1537.79	194.95	Positive
393D	381	1538.18	194.90	Negative
	385	1538.58	194.85	Positive
	389	1538.97	194.80	Negative
	393	1539.37	194.75	Positive

*1 The value which omitted and computed the 3rd place below the decimal point

Table A: DWDM wavelength base on ITU-T recommendations (@ T_{LD} = T_{set}) (2/7)

Wavelength Code		ITU-T Wavelength *1 (nm)	Frequency (THz)	Monitor Slope
4 channel tunable	single channel			
409D	397	1539.76	194.70	Negative
	401	1540.16	194.65	Positive
	405	1540.55	194.60	Negative
	409	1540.95	194.55	Positive
425D	413	1541.34	194.50	Negative
	417	1541.74	194.45	Positive
	421	1542.14	194.40	Negative
	425	1542.53	194.35	Positive
441D	429	1542.93	194.30	Negative
	433	1543.33	194.25	Positive
	437	1543.73	194.20	Negative
	441	1544.12	194.15	Positive
457D	445	1544.52	194.10	Negative
	449	1544.92	194.05	Positive
	453	1545.32	194.00	Negative
	457	1545.72	193.95	Positive
473D	461	1546.11	193.90	Negative
	465	1546.51	193.85	Positive
	469	1546.91	193.80	Negative
	473	1547.31	193.75	Positive
489D	477	1547.71	193.70	Negative
	481	1548.11	193.65	Positive
	485	1548.51	193.60	Negative
	489	1548.91	193.55	Positive
505D	493	1549.31	193.50	Negative
	497	1549.71	193.45	Positive
	501	1550.11	193.40	Negative
	505	1550.51	193.35	Positive
521D	509	1550.91	193.30	Negative
	513	1551.31	193.25	Positive
	517	1551.72	193.20	Negative
	521	1552.12	193.15	Positive

*1 The value which omitted and computed the 3rd place below the decimal point

Table A: DWDM wavelength base on ITU-T recommendations (@ T_{LD} = T_{set}) (3/7)

Wavelength Code		ITU-T Wavelength *1 (nm)	Frequency (THz)	Monitor Slope
4 channel tunable	single channel			
537D	525	1552.52	193.10	Negative
	529	1552.92	193.05	Positive
	533	1553.32	193.00	Negative
	537	1553.73	192.95	Positive
553D	541	1554.13	192.90	Negative
	545	1554.53	192.85	Positive
	549	1554.94	192.80	Negative
	553	1555.34	192.75	Positive
569D	557	1555.74	192.70	Negative
	561	1556.15	192.65	Positive
	565	1556.55	192.60	Negative
	569	1556.95	192.55	Positive
585D	573	1557.36	192.50	Negative
	577	1557.76	192.45	Positive
	581	1558.17	192.40	Negative
	585	1558.57	192.35	Positive
602D	589	1558.98	192.30	Negative
	593	1559.38	192.25	Positive
	597	1559.79	192.20	Negative
	602	1560.20	192.15	Positive
618D	606	1560.60	192.10	Negative
	610	1561.01	192.05	Positive
	614	1561.41	192.00	Negative
	618	1561.82	191.95	Positive
634D	622	1562.23	191.90	Negative
	626	1562.64	191.85	Positive
	630	1563.04	191.80	Negative
	634	1563.45	191.75	Positive
650D	638	1563.86	191.70	Negative
	642	1564.27	191.65	Positive
	646	1564.67	191.60	Negative
	650	1565.08	191.55	Positive

*1 The value which omitted and computed the 3rd place below the decimal point

Table A: DWDM wavelength base on ITU-T recommendations (@ T_{LD} = T_{set}) (4/7)

Wavelength Code		ITU-T Wavelength *1 (nm)	Frequency (THz)	Monitor Slope
4 channel tunable	single channel			
667D	654	1565.49	191.50	Negative
	659	1565.90	191.45	Positive
	663	1566.31	191.40	Negative
	667	1566.72	191.35	Positive
683D	671	1567.13	191.30	Negative
	675	1567.54	191.25	Positive
	679	1567.95	191.20	Negative
	683	1568.36	191.15	Positive
700D	687	1568.77	191.10	Negative
	691	1569.18	191.05	Positive
	695	1569.59	191.00	Negative
	700	1570.00	190.95	Positive
716D	704	1570.41	190.90	Negative
	708	1570.82	190.85	Positive
	712	1571.23	190.80	Negative
	716	1571.65	190.75	Positive
733D	720	1572.06	190.70	Negative
	724	1572.47	190.65	Positive
	728	1572.88	190.60	Negative
	733	1573.30	190.55	Positive
749D	737	1573.71	190.50	Negative
	741	1574.12	190.45	Positive
	745	1574.54	190.40	Negative
	749	1574.95	190.35	Positive
766D	753	1575.36	190.30	Negative
	757	1575.78	190.25	Positive
	761	1576.19	190.20	Negative
	766	1576.61	190.15	Positive
782D	770	1577.02	190.10	Negative
	774	1577.44	190.05	Positive
	778	1577.85	190.00	Negative
	782	1578.27	189.95	Positive

*1 The value which omitted and computed the 3rd place below the decimal point

Table A: DWDM wavelength base on ITU-T recommendations (@ T_{LD} = T_{set}) (5/7)

Wavelength Code		ITU-T Wavelength *1 (nm)	Frequency (THz)	Monitor Slope
4 channel tunable	single channel			
799D	786	1578.68	189.90	Negative
	791	1579.10	189.85	Positive
	795	1579.51	189.80	Negative
	799	1579.93	189.75	Positive
816D	803	1580.35	189.70	Negative
	807	1580.76	189.65	Positive
	811	1581.18	189.60	Negative
	816	1581.60	189.55	Positive
832D	820	1582.01	189.50	Negative
	824	1582.43	189.45	Positive
	828	1582.85	189.40	Negative
	832	1583.27	189.35	Positive
849D	836	1583.69	189.30	Negative
	841	1584.10	189.25	Positive
	845	1584.52	189.20	Negative
	849	1584.94	189.15	Positive
866D	853	1585.36	189.10	Negative
	857	1585.78	189.05	Positive
	862	1586.20	189.00	Negative
	866	1586.62	188.95	Positive
883D	870	1587.04	188.90	Negative
	874	1587.46	188.85	Positive
	878	1587.88	188.80	Negative
	883	1588.30	188.75	Positive
899D	887	1588.72	188.70	Negative
	891	1589.14	188.65	Positive
	895	1589.56	188.60	Negative
	899	1589.98	188.55	Positive
916D	904	1590.41	188.50	Negative
	908	1590.83	188.45	Positive
	912	1591.25	188.40	Negative
	916	1591.67	188.35	Positive

*1 The value which omitted and computed the 3rd place below the decimal point

Table A: DWDM wavelength base on ITU-T recommendations (@ T_{LD} = T_{set}) (6/7)

Wavelength Code		ITU-T Wavelength *1 (nm)	Frequency (THz)	Monitor Slope
4 channel tunable	single channel			
933D	921	1592.10	188.30	Negative
	925	1592.52	188.25	Positive
	929	1592.94	188.20	Negative
	933	1593.36	188.15	Positive
950D	937	1593.79	188.10	Negative
	942	1594.21	188.05	Positive
	946	1594.64	188.00	Negative
	950	1595.06	187.95	Positive
967D	954	1595.48	187.90	Negative
	959	1595.91	187.85	Positive
	963	1596.33	187.80	Negative
	967	1596.76	187.75	Positive
984D	971	1597.18	187.70	Negative
	976	1597.61	187.65	Positive
	980	1598.04	187.60	Negative
	984	1598.46	187.55	Positive
6001D	988	1598.89	187.50	Negative
	993	1599.32	187.45	Positive
	997	1599.74	187.40	Negative
	6001	1600.17	187.35	Positive
6018D	6006	1600.60	187.30	Negative
	6010	1601.02	187.25	Positive
	6014	1601.45	187.20	Negative
	6018	1601.88	187.15	Positive
6035D	6023	1602.31	187.10	Negative
	6027	1602.74	187.05	Positive
	6031	1603.16	187.00	Negative
	6035	1603.59	186.95	Positive
6053D	6040	1604.02	186.90	Negative
	6044	1604.45	186.85	Positive
	6048	1604.88	186.80	Negative
	6053	1605.31	186.75	Positive

*1 The value which omitted and computed the 3rd place below the decimal point

Table A: DWDM wavelength base on ITU-T recommendations (@ T_{LD} = T_{set}) (7/7)

Wavelength Code		ITU-T Wavelength *1 (nm)	Frequency (THz)	Monitor Slope
4 channel tunable	single channel			
6070D	6057	1605.74	186.70	Negative
	6061	1606.17	186.65	Positive
	6066	1606.60	186.60	Negative
	6070	1607.03	186.55	Positive
6087D	6074	1607.46	186.50	Negative
	6078	1607.89	186.45	Positive
	6083	1608.32	186.40	Negative
	6087	1608.76	186.35	Positive

*1 The value which omitted and computed the 3rd place below the decimal point

TYPICAL CHARACTERISTICS ($T_{LD} = 25^{\circ}\text{C}$, unless otherwise specified)

SPECTRUM

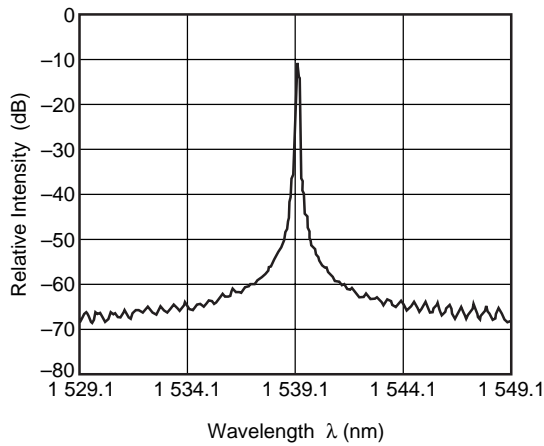

OPTICAL OUTPUT POWER FROM FIBER, MONITOR CURRENT (P_f MONITOR) vs. FORWARD CURRENT

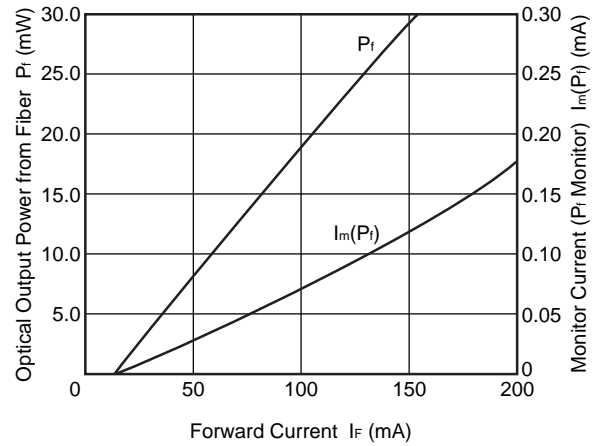

THERMISTOR RESISTANCE vs. AMBIENT TEMPERATURE

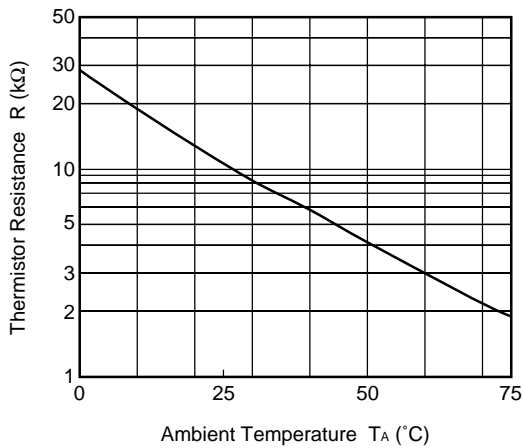

COOLER ELECTRIC POWER CONSUMPTION vs. LASER SET TEMPERATURE

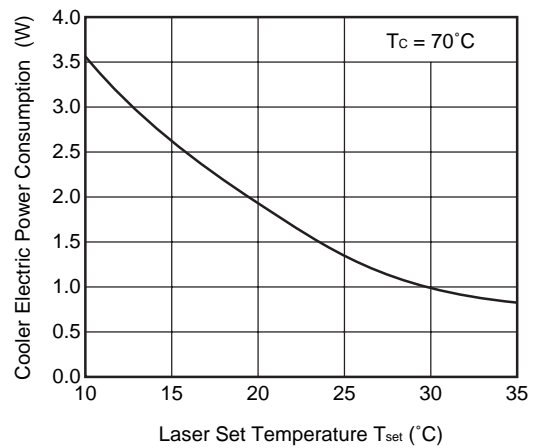

Remark The graphs indicate nominal characteristics.

REFERENCE

Document Name	Document No.
OPTICAL SEMICONDUCTOR DEVICES FOR FIBEROPTIC COMMUNICATIONS SELECTION GUIDE	PL10161E
Opto-Electronics Devices Pamphlet	PX10160E

Subject: Compliance with EU Directives

CEL certifies, to its knowledge, that semiconductor and laser products detailed below are compliant with the requirements of European Union (EU) Directive 2002/95/EC Restriction on Use of Hazardous Substances in electrical and electronic equipment (RoHS) and the requirements of EU Directive 2003/11/EC Restriction on Penta and Octa BDE.

CEL Pb-free products have the same base part number with a suffix added. The suffix –A indicates that the device is Pb-free. The –AZ suffix is used to designate devices containing Pb which are exempted from the requirement of RoHS directive (*). In all cases the devices have Pb-free terminals. All devices with these suffixes meet the requirements of the RoHS directive.

This status is based on CEL’s understanding of the EU Directives and knowledge of the materials that go into its products as of the date of disclosure of this information.

Restricted Substance per RoHS	Concentration Limit per RoHS (values are not yet fixed)	Concentration contained in CEL devices	
		-A	-AZ
Lead (Pb)	< 1000 PPM	Not Detected	(*)
Mercury	< 1000 PPM	Not Detected	
Cadmium	< 100 PPM	Not Detected	
Hexavalent Chromium	< 1000 PPM	Not Detected	
PBB	< 1000 PPM	Not Detected	
PBDE	< 1000 PPM	Not Detected	

If you should have any additional questions regarding our devices and compliance to environmental standards, please do not hesitate to contact your local representative.

Important Information and Disclaimer: Information provided by CEL on its website or in other communications concerning the substance content of its products represents knowledge and belief as of the date that it is provided. CEL bases its knowledge and belief on information provided by third parties and makes no representation or warranty as to the accuracy of such information. Efforts are underway to better integrate information from third parties. CEL has taken and continues to take reasonable steps to provide representative and accurate information but may not have conducted destructive testing or chemical analysis on incoming materials and chemicals. CEL and CEL suppliers consider certain information to be proprietary, and thus CAS numbers and other limited information may not be available for release.

In no event shall CEL’s liability arising out of such information exceed the total purchase price of the CEL part(s) at issue sold by CEL to customer on an annual basis.

See CEL Terms and Conditions for additional clarification of warranties and liability.