

# Monitoring Relays 1-Phase True RMS AC/DC Over or Under Current Types DIB01, PIB01



- TRMS AC/DC over or under current monitoring relay
- Current measuring through internal shunt
- Selection of measuring range by DIP-switches
- Measuring ranges from 0.1 mA to 10 A AC/DC
- Adjustable current on relative scale
- Adjustable hysteresis on relative scale
- Adjustable delay function (0.1 to 30 s)
- Programmable latching or inhibit at set level
- Output: 8 A SPDT relay N.D. or N.E. selectable
- For mounting on DIN-rail in accordance with DIN/EN 50 022 (DIB01) or plug-in module (PIB01)
- 22.5 mm Euronorm housing (DIB01) or 36 mm plug-in module (PIB01)
- LED indication for relay, alarm and power supply ON
- Galvanically separated power supply

## Product Description

DIB01 and PIB01 are precise TRMS AC/DC over or under current (selectable by DIP-switch) monitoring relays. Direct measuring or through current transformer. Owing to the built-in latch function, the ON-position of the relay output can be maintained. Inhibit function

can be used to avoid relay operation when not desired (maintenance, transitions). The LED's indicate the state of the alarm and the output relay. Through the built-in shunt it is possible to monitor loads up to 10 A AC/DC.

## Ordering Key

**DIB 01 C B23 5A**

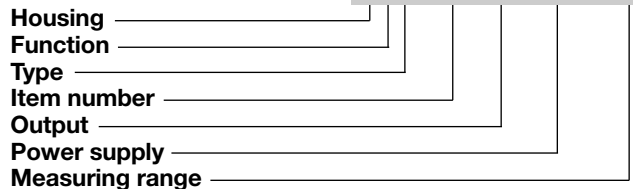

## Type Selection

Mounting	Output	Measuring range	Supply: 24 VDC	Supply: 48 VDC	Supply: 24/48 VAC	Supply: 115/230 VAC
DIN-rail	SPDT	0.1 to 5 mA AC/DC	DIB 01 C 724 5mA	DIB 01 C 748 5mA	DIB 01 C B48 5mA	DIB 01 C B23 5mA
		1 to 50 mA AC/DC	DIB 01 C 724 50mA	DIB 01 C 748 50mA	DIB 01 C B48 50mA	DIB 01 C B23 50mA
		10 to 500 mA AC/DC	DIB 01 C 724 500mA	DIB 01 C 748 500mA	DIB 01 C B48 500mA	DIB 01 C B23 500mA
		0.1 to 5 A AC/DC	DIB 01 C 724 5A	DIB 01 C 748 5A	DIB 01 C B48 5A	DIB 01 C B23 5A
Plug-in	SPDT	1 to 10 A AC/DC	DIB 01 C 724 10A	DIB 01 C 748 10A	DIB 01 C B48 10A	DIB 01 C B23 10A
		0.1 to 5 mA AC/DC	PIB 01 C 724 5mA	PIB 01 C 748 5mA	PIB 01 C B48 5mA	PIB 01 C B23 5mA
		1 to 50 mA AC/DC	PIB 01 C 724 50mA	PIB 01 C 748 50mA	PIB 01 C B48 50mA	PIB 01 C B23 50mA
		10 to 500 mA AC/DC	PIB 01 C 724 500mA	PIB 01 C 748 500mA	PIB 01 C B48 500mA	PIB 01 C B23 500mA
		0.1 to 5 A AC/DC	PIB 01 C 724 5A	PIB 01 C 748 5A	PIB 01 C B48 5A	PIB 01 C B23 5A
		1 to 10 A AC/DC	PIB 01 C 724 10A	PIB 01 C 748 10A	PIB 01 C B48 10A	PIB 01 C B23 10A

## Input Specifications

Input (current level)	Terminals Y1, Y2	Terminals 5, 7	Measuring ranges (cont.)	Internal resist.	Max. curr.
DIB01			<b>..500mA:</b> 10 to 100 mA AC/DC 20 to 200 mA AC/DC 50 to 500 mA AC/DC Max. current for 1 s	0.5 Ω	700 mA
PIB01					
<b>Measuring ranges</b>	<b>Internal resist.</b>	<b>Max. curr.</b>	<b>..5A:</b> 0.1 to 1 A AC/DC 0.2 to 2 A AC/DC 0.5 to 5 A AC/DC Max. current for 1 s	0.05 Ω	6 A
Direct					
Selectable by DIP-switch			<b>..10A:</b> 1 to 10 A AC/DC Max. current for 1 s	3 mΩ	15 A
<b>..5mA:</b> 0.1 to 1 mA AC/DC	50 Ω	50 mA			
0.2 to 2 mA AC/DC	50 Ω	50 mA			
0.5 to 5 mA AC/DC	50 Ω	50 mA			
Max. current for 1 s		100 mA			
<b>..50mA:</b> 1 to 10 mA AC/DC	5 Ω	150 mA			
2 to 20 mA AC/DC	5 Ω	150 mA			
5 to 50 mA AC/DC	5 Ω	150 mA			
Max. current for 1 s		500 mA			



## Input Specifications (cont.)

### Measuring ranges (cont.)

Standard CT (examples)	AAC <sub>rms</sub>	Max. curr.
TADK2 50 A/5 A	5 to 50 A	60 A
TAD2 150 A/5 A	15 to 150 A	180 A
TAD6 400 A/5 A	40 to 400 A	480 A
TAD12 1000 A/5 A	100 to 1000 A	1200 A
TACO200 6000 A/5 A	600 to 6000 A	7200 A

#### Note:

The input voltage cannot raise over 300 VAC/DC with respect to ground (PIB01 only)

### Contact input

DIB01	Terminals Z1, Y1
PIB01	Terminals 8, 9
Disabled	> 10 kΩ
Enabled	< 500 Ω
Latch disable	> 500 ms

## Output Specifications

<b>Output</b>	SPDT relay
Rated insulation voltage	250 VAC
<b>Contact ratings (AgSnO<sub>2</sub>)</b>	μ
Resistive loads	AC 1 8 A @ 250 VAC
	DC 12 5 A @ 24 VDC
Small inductive loads	AC 15 2.5 A @ 250 VAC
	DC 13 2.5 A @ 24 VDC
<b>Mechanical life</b>	≥ 30 x 10 <sup>6</sup> operations
<b>Electrical life</b>	≥ 10 <sup>5</sup> operations (at 8 A, 250 V, cos φ = 1)
<b>Operating frequency</b>	~ 7200 operations/h
<b>Dielectric strength</b>	
Dielectric voltage	≥ 2 kVAC (rms)
Rated impulse withstand volt.	4 kV (1.2/50 μs)

## Supply Specifications

<b>Power supply</b>	Overvoltage cat. III (IEC 60664, IEC 60038)	
Rated operational voltage through terminals:		
A1, A2 or A3, A2 (DIB01)		
2, 10 or 11, 10 (PIB01)		
724:	24 VDC ± 20%, insulated	
784:	48 VDC ± 20%, insulated	
B48:	24/48 VAC ± 15%	
	45 to 65 Hz, insulated	
B23:	115/230 VAC ± 15%	
	45 to 65 Hz, insulated	
<b>Dielectric voltage</b>	<b>DC supply</b>	<b>AC supply</b>
Supply to input	2 kV	4 kV
Supply to output	4 kV	4 kV
Input to output	4 kV	4 kV
<b>Rated operational power</b>		
AC	4 VA	
DC	3 W	

## General Specifications

<b>Power ON delay</b>	1 s ± 0.5 s or 6 s ± 0.5 s
<b>Reaction time</b>	(input signal variation from -20% to +20% or from +20% to -20% of set value)
Alarm ON delay	< 100 ms
Alarm OFF delay	< 100 ms
<b>Accuracy</b>	(15 min warm-up time)
Temperature drift	± 1000 ppm/°C
Delay ON alarm	± 10% on set value ± 50 ms
Repeatability	± 0.5% on full-scale
<b>Indication for</b>	
Power supply ON	LED, green
Alarm ON	LED, red (flashing 2 Hz during delay time)
Output relay ON	LED, yellow
<b>Environment</b>	(EN 60529)
Degree of protection	IP 20
Pollution degree	3 (DIB01), 2 (PIB01)
Operating temperature	-20 to 60°C, R.H. < 95%
Storage temperature	-30 to 80°C, R.H. < 95%
<b>Housing</b>	
Dimensions	DIB01 22.5 x 80 x 99.5 mm PIB01 36 x 80 x 94 mm
<b>Weight</b>	Approx. 150 g
<b>Screw terminals</b>	
Tightening torque	Max. 0.5 Nm acc. to IEC 60947
<b>Approvals</b>	UL, CSA (except 748)
<b>CE Marking</b>	Yes
<b>EMC</b>	
Immunity	Electromagnetic Compatibility
Emission	According to EN 61000-6-2 According to EN 61000-6-3

## Mode of Operation

DIB01 and PIB01 monitor both AC and DC over or under current through an internal shunt.

### Example 1

(connection between terminals Z1, Y1 or 8, 9 - latching function enabled)

The relay operates and latches in operating position when the measured value

exceeds (or drops below) the set level for more than the set delay time. Provided that the current has dropped below (or has exceeded) the set point (see hysteresis setting), the relay releases when the interconnection between terminals Z1, Y1 or 8, 9 is interrupted or the power supply is interrupted as well. The red LED flashes until the delay time has expired or the

measured value comes back to a non-alarm value (see hysteresis setting).

### Example 2 (Standard CT)

(no connection between terminals Z1, Y1 or 8, 9 - latch function disabled)

The relay operates when the measured value exceeds (or drops below) the set level for more than the set delay time.

It releases when the current drops below (or exceeds) the set level (see hysteresis setting) or when power supply is interrupted.

### Note

When the inhibit contact is opened, if the input signal is already in alarm position, the delay time needs to elapse before relay activation.

## Function/Range/Level and Time Delay Setting

Adjust the input range setting the DIP switches 1 and 2 as shown below (except for models DIB01xxx10A and PIB01xxx10A). Select the desired function setting the DIP switches 3 to 6 (1 to 4 for DIB01xxx10A and PIB01xxx10A) as shown

below.

To access the DIP switches open the grey plastic cover as shown below.

### Selection of level and time delay:

#### Upper knob:

Setting of hysteresis on relative scale: 0 to 30% on set value.

#### Centre knob:

Current level setting on relative scale: 10 to 110% on full scale.

#### Lower knob:

Setting of delay on alarm time on absolute scale (0.1 to 30 s).

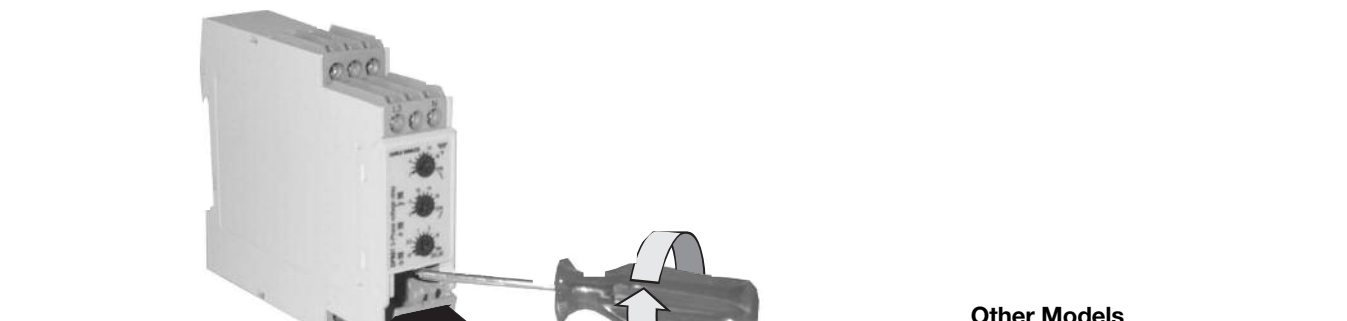

**10 A Models**

ON ↑	1	<b>Relay working mode</b> ON: Normally De-energized OFF: Normally Energized
2	<b>Power ON delay</b> ON: 6 s ± 0.5 s OFF: 1 s ± 0.5 s	
3	<b>Contact input</b> ON: Latch function enable OFF: Inhibit function enable	
4	<b>Monitoring function</b> ON: Over current OFF: Under current	

**Other Models**

Measuring range			
SW1	ON	ON	OFF
SW2	OFF	ON	ON
5MA	1 mA	2 mA	5 mA
50MA	10 mA	20 mA	50 mA
500MA	100 mA	200 mA	500 mA
5A	1 A	2 A	5 A

ON ↑	1	<b>Relay working mode</b> ON: Normally De-energized OFF: Normally Energized
2	<b>Power ON delay</b> ON: 6 s ± 0.5 s OFF: 1 s ± 0.5 s	
3	<b>Contact input</b> ON: Latch function enable OFF: Inhibit function enable	
4	<b>Monitoring function</b> ON: Over current OFF: Under current	

## Operation Diagrams

### Over current - N.D. relay

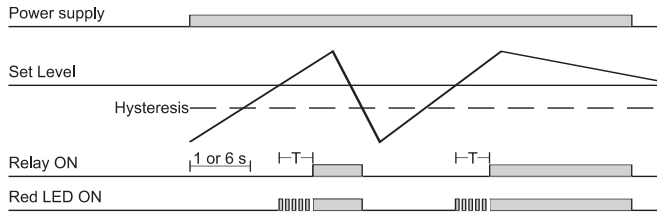

### Under current - Latch function - N.D. relay

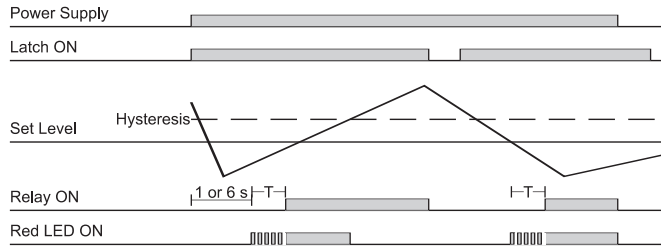

### Under current - N.D. relay

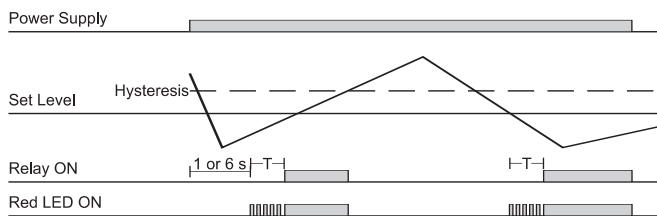

### Over current - Inhibit function - N.D. relay

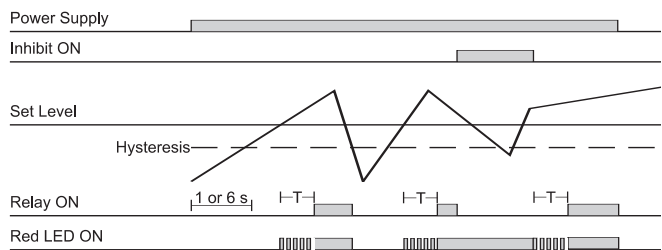

## Wiring Diagrams

### Example 1

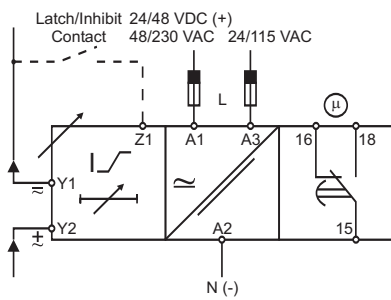

### Example 2

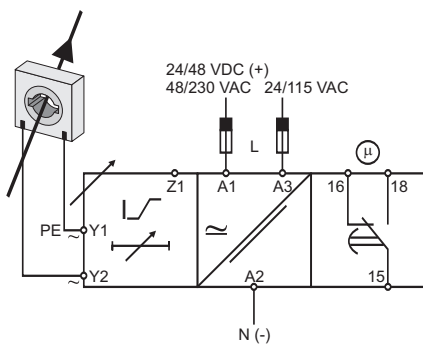

DIB01

### Example 1

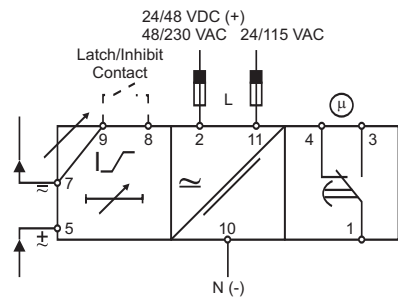

### Example 2

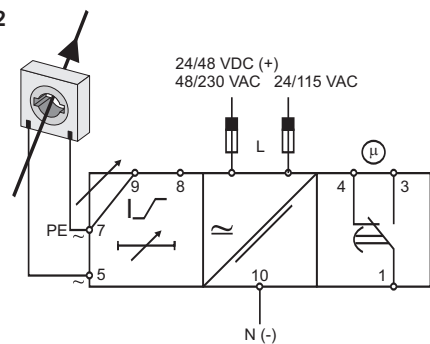

PIB01

## Dimensions

