

10BASE-T/FIBER APPLICATION FILTER MODULE

- Designed for use with Microlinear ML 4664/4669 10Base-T UTP to Fiber application chips
- Includes TP-PMD filter network, available with and without common mode choke
- Low profile, robust surface mount packaging, rated to withstand 225°C peak IR reflow temperature
- 2000 Vrms isolation

ELECTRICALS AT 25°C

Part No.	Insertion Loss (dB) Max 1-10MHz	Attenuation (dB) Min			Return Loss (dB) Min 5MHz-10MHz	Crosstalk (dB) Min 1MHz-10MHz	CM-CM Rej (dB) Min		Schematic
		25MHz	30MHz	40MHz			1-10MHz	10-100MHz	
S556-2793-00	-1.0	-5	-10	-16	-15	-30	--	--	A
S556-2793-01	-1.1	-5	-10	-16	-15	-30	-40	-30	B

SCHEMATICS

A

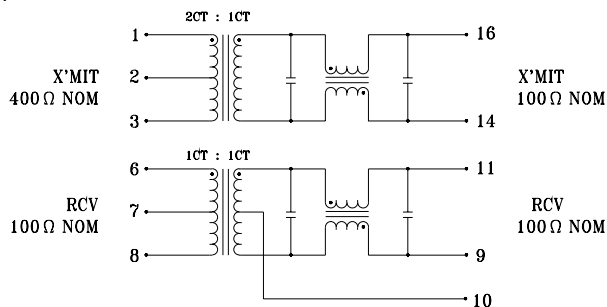

B

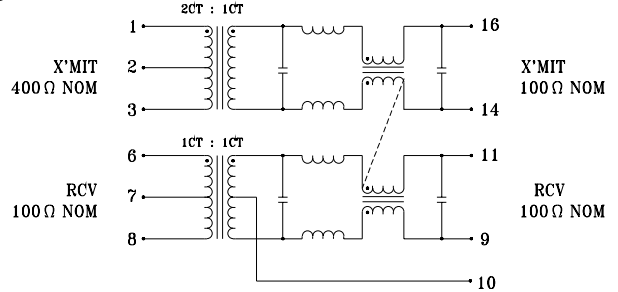

MECHANICAL

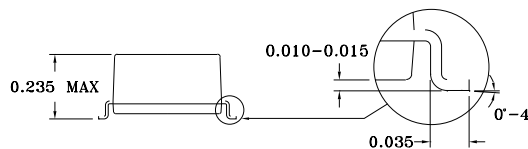
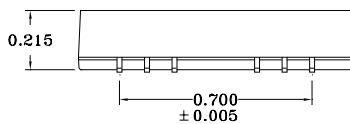
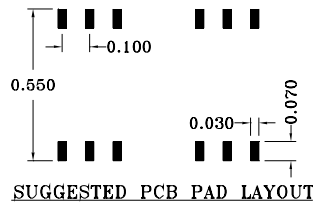
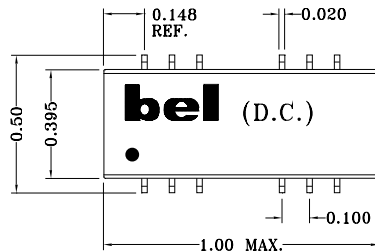

Specifications subject to change without notice.

**10BASE-T/FIBER APPLICATION
FILTER MODULE**

960036A

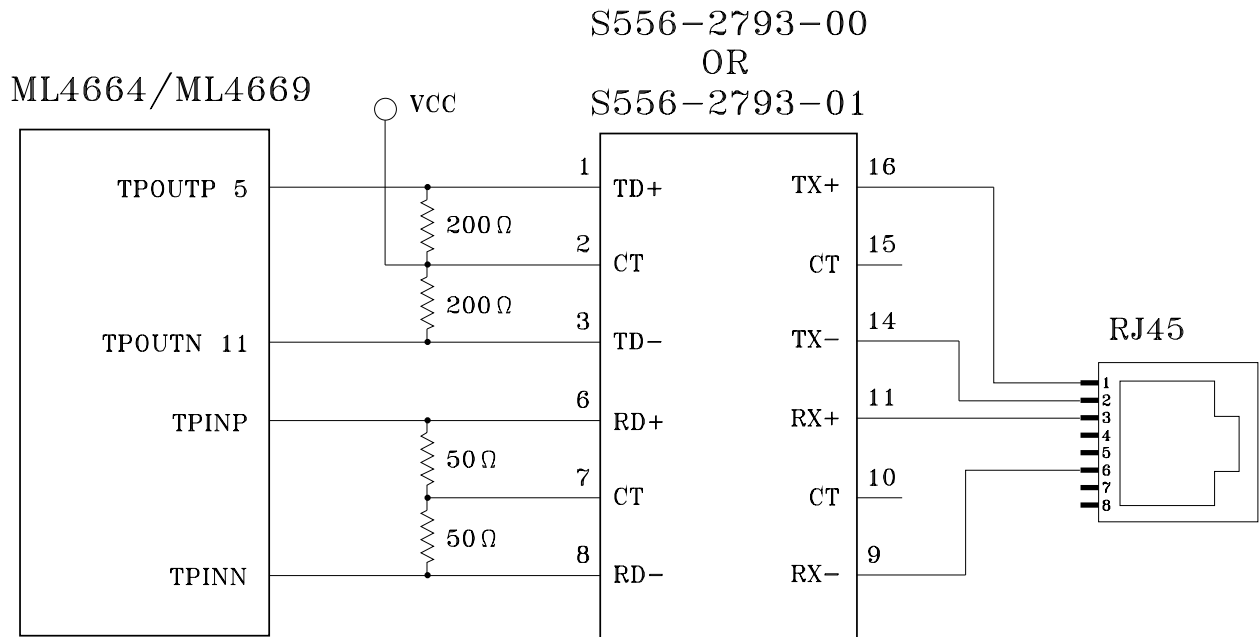
APPLICATION CIRCUIT**APPLICATION NOTES**

- Bel has developed a series of filter modules for Microlinear's 10Base-T twisted pair to fiber conversion chipsets. Each module includes a 400 ohm transmit and 100 ohm receive filter, impedance matched to the Microlinear chipset for signal shaping, high voltage isolation transformers, and center taps for grounding. An optional common mode choke is available for further EMI and noise suppression.
- Bel's low profile, surface mount packaging is ideal for high speed pick and place machinery. Parts can be shipped on tape and reel for high speed placement. Construction processes have been implemented for thermal compatibility with high temperature IR reflow assembly processing. Post dipping of leads assist with PC board solderability. Each part is optically inspected to meet rigid coplanarity requirements.

Corporate Office

Bel Fuse Inc.
198 Van Vorst Street, Jersey City, NJ 07302-4496
Tel: 201-432-0463
Fax: 201-432-9542
E-Mail: BelFuse@belfuse.com
Internet: <http://www.belfuse.com>

Far East Office

Bel Fuse Ltd.
8F/8 Luk Hop Street
San Po Kong
Kowloon, Hong Kong
Tel: 852-2328-5515
Fax: 852-2352-3706

European Office

Bel Fuse Europe Ltd.
Preston Technology Management Centre
Marsh Lane, Preston PR1 8UD
Lancashire, U.K.
Tel: 44-1772-556601
Fax: 44-1772-888366