

Description

This device is power factor correction controller using a discontinues conduction mode of boost converter. Especially, it is optimized for electronic ballasts which prevent abnormal functions in load runaway and feedback loop fault conditions and low power and high density power supplies which require minimum board size. The external component R/C filter is not necessary because the R/C filter is included in current sense block. This is the improved version with a pin out equivalent to world standard.

Features

- Dynamic, Static & Feedback OVP
- Extremely Low Start up Current (30uA Typ.)
- Very Low Operating Current (4mA Typ.)
- Internal Self Start Timer
- Current Sense with Internal RC Filter
- Trimmed $\pm 1.5\%$ internal Reference
- Under Voltage Lock Out with Hysteresis
- Pin Compatible to World Standard
- High Current Totem Pole Gate Drive

Applications

- Electronic Ballast
- SMPS

Ordering Information

Type NO.	Marking	Package Code
S6500	S6500	SOP-8

Outline Dimensions

unit : mm

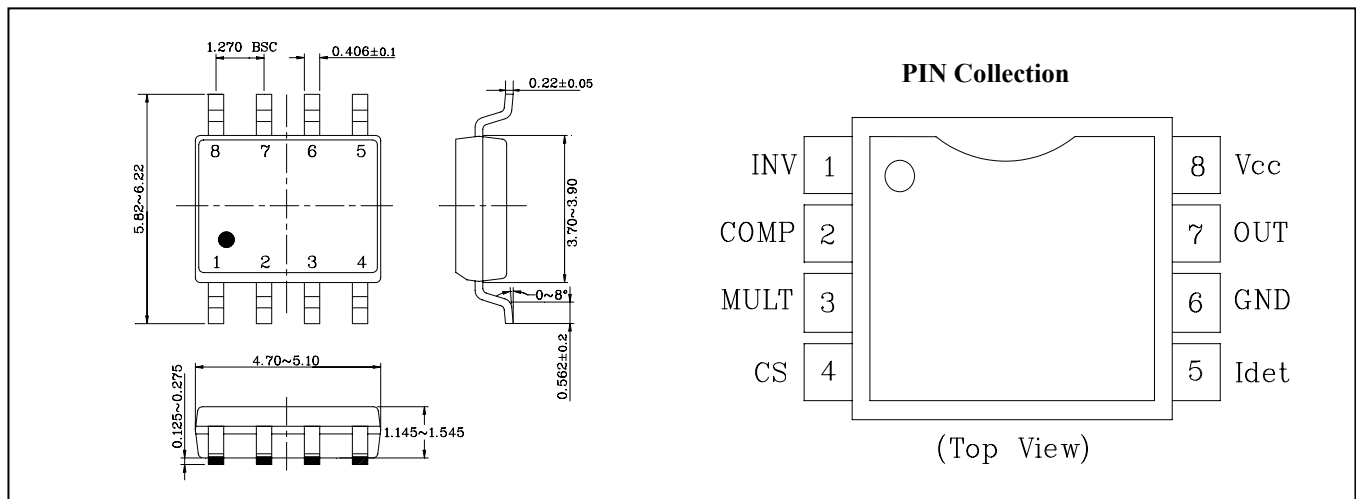

Internal Block Diagram

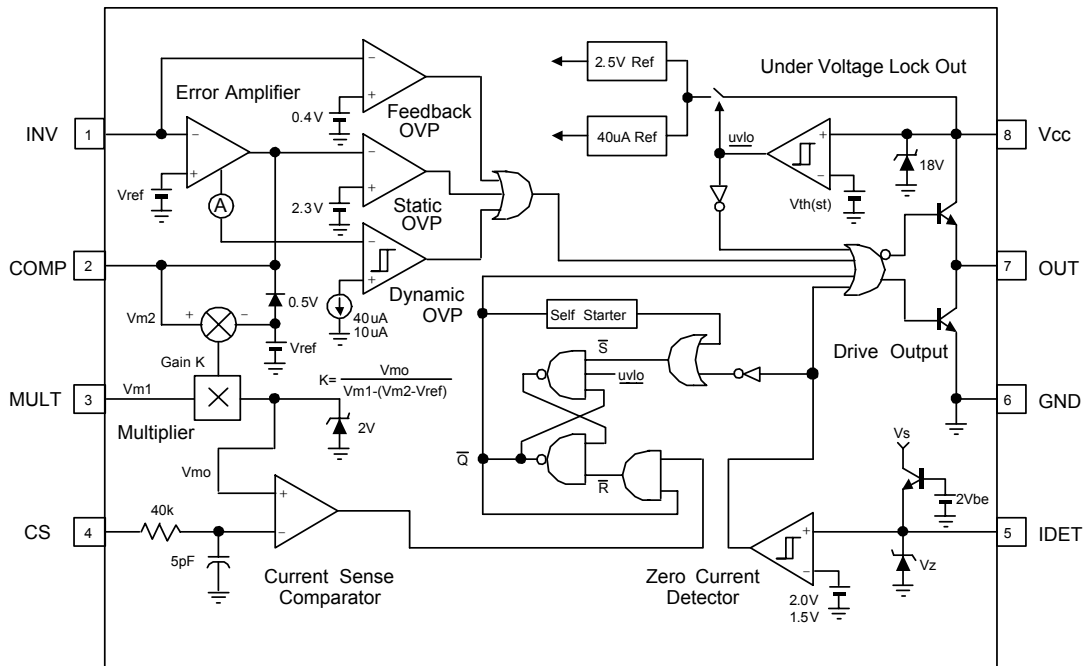

Absolute Maximum Ratings

Characteristics	Symbol	Value	Units
Supply Voltage	V _{CC}	18	V
Supply voltage Regulator Maximum Current	I _{CC(max)}	35	mA
Peak Drive Output Current	I _{oh, lol}	± 500	mA
Driver Output Clamping Diodes V _o >V _{cc} or V _o <-.3V	I _{clamp}	± 10	mA
Detect Clamping Diodes	I _{det}	± 10	mA
Error Amp, Compensation and Multiplier Input Voltage	V _{in}	-0.3 to 6	V
Power Dissipation @ Tamb=50°C	P _d	0.65	W

Thermal Data

Thermal Resistance Junction-Ambient	R _{th(j-amb)}	100	°C/W
-------------------------------------	------------------------	-----	------

PIN Function

Pin Number	Pin Name	Pin Function Description
1	INV	Inverting input of the error amplifier. The output of the boost converter should be resistively divided to 2.5V and Connected to this pin.
2	COMP	Output of the error amplifier. A feedback compensation network is placed between this pin and the INV pin.
3	MULT	Input to the multiplier stage. The full wave rectified AC voltage is divided to less than 4V and is connected to this pin.
4	CS	Input to the comparator of the control loop. The MOSFET current is sensed by a resistor and the resulting voltage is applied to this pin. An internal R/C filter is Included to reject any high frequency noise.
5	IDET	Zero current detection input.
6	GND	Ground of the control section.
7	OUT	Gate drive output. A push pull output stage is able to drive the power MOSFET with peak current of 500mA.
8	Vcc	Supply voltage of driver and control circuits.

Electrical Characteristics

$V_{cc}=12V$, $-25^{\circ}C \leq T_a \leq 125^{\circ}C$, unless otherwise specified.

Characteristic	Symbol	Test Condition	Min.	Typ.	Max.	Unit
SUPPLY VOLTAGE & CURRENT SECTION						
Start Threshold Voltage	$V_{th(st)}$	V_{cc} Increasing	9.5	10.5	11.5	V
UVLO Hysteresis	$HY(st)$	-	1.5	2.5	3.5	V
Start up Supply Current	I_{st}	$V_{cc}=9V$	5	30	50	μA
Operating Supply Current	I_{cc}	Output not switching	-	3	6	mA
Operating Current at OVP	I_{occ}	INV=3V	-	1.6	2.5	mA
Dynamic Operating Supply Current	I_{dcc}	50kHz, $C_I=1nF$	-	4	8	mA
Maximum Supply Voltage	$V_{cc(max)}$	$I_{cc}=30mA$	17	18	19	V
ERROR AMPLIFIER SECTION						
Voltage Feedback Input Threshold	V_{ref}	$I_{ref}=0mA$, $T_a=25^{\circ}C$	2.465	2.5	2.535	V
Line Regulation (note 1)	ΔV_{ref1}	$12V \leq V_{cc} \leq 17V$	-	0.1	10	mV
Temperature Stability of V_{ref} (note 1)	ΔV_{ref2}	Temp= $-25^{\circ}C$ to $85^{\circ}C$	-	20	-	mV
Input Bias Current (Pin1)	$I_{b(ea)}$	-	-0.5	-	0.5	μA
Output Source Current	I_{source}	INV=2V, $V_{m2}=4V$	-2	-5	-	mA
Output Sink Current	I_{sink}	INV=3V, $V_{m2}=4V$	3	6	-	mA
Lower Clamp Voltage	V_{low}	INV=3V	1.9	2	2.1	V
MULTIPLIER SECTION						
Input Bias Current (Pin3)	$I_{b(m)}$	-	-0.5	-	0.5	μA
M1 Input Voltage Range (pin3) (note2)	ΔV_{m1}	Range From 0V	4	4.5	-	V
M2 Input Voltage Range (pin2) (note2)	ΔV_{m2}	Range From V_{ref}	$V_{ref}+25$	$V_{ref}+3$	-	V
Multiplier Gain (note 3)	K	$V_{m1}=1V$, $V_{m2}=4V$	0.45	0.6	0.75	1/V
Maximum Multiplier Output Voltage	$V_{mo(max)}$	INV=1V, $V_{m1}=4V$	1.8	2	2.2	V

Electrical Characteristics

$V_{cc}=12V$, $-25^{\circ}C \leq T_a \leq 125^{\circ}C$, unless otherwise specified.

Characteristic	Symbol	Test Condition	Min.	Typ.	Max.	Unit
CURRENT SENSE COMPARATOR						
Input Offset Voltage	$V_{io(cs)}$	$V_{m1}=0V, V_{m2}=2.3V$	0	10	25	mV
Input Bias Current (Pin4)	$I_{b(cs)}$	$0V \leq V_{cs} \leq 1.8V$	-0.5	-	.05	μA
Current Sense Delay to Output (note2)	$t_{d(cs)}$	-	-	200	500	ns
ZERO CURRENT DETECTOR						
Input Voltage Threshold	$V_{th(det)}$	Vdet Increasing	1.7	2	2.3	V
Detect Hysteresis	$H_{Y(det)}$	-	0.2	0.5	0.8	V
Input Low Clamp Voltage	$V_{clamp(l)}$	$I_{det}=-3mA$	0.4	0.8	1.2	V
Input High Clamp Voltage	$V_{clamp(h)}$	$I_{det}=3mA$	6	7.5	9	V
Input Bias Current (Pin5)	$I_{b(det)}$	$1V \leq V_{det} \leq 5V$	-1	-0.1	1	μA
Input High/Low Clamp Diode Current (note 2)	I_{clamp}	-	-	-	± 3	mA
OUTPUT SECTION						
Output Voltage High	V_{oh}	$I_o=10mA$	8.5	10	-	V
Output Voltage Low	V_{ol}	$I_o=10mA$	-	1.5	2	V
Rising Time (note2)	t_r	$C_l=1nF$	-	120	200	nS
Falling Time (note2)	t_f	$C_l=1nF$	-	50	120	nS
Output Voltage with UVLO Activated	$V_{o(uvlo)}$	$V_{cc}=5V, I_o=50\mu A$	-	-	1	V
SELF STARTER SECTION						
Self Start Time Delay (note2)	$t_{d(ss)}$	$V_{m1}=1V, V_{m2}=3.5V$	-	150	-	μs
OVER VOLTAGE PROTECTION SECTION						
Feedback OVP Threshold Voltage	$V_{th(f)}$	-	0.3	0.4	0.5	V
Dynamic OVP Detecting Current	$I_{ovp(d)}$	-	35	40	45	μA
Static OVP Threshold Voltage	$V_{th(s)}$	-	2.15	2.3	2.45	V

Note : 1) Because the reference is not brought out externally, this specification can't be tested on the package Part. It is guaranteed by design.

2) This parameter, although guaranteed, is not tested in production.

3) Multiplier gain $K = V_{mo} / (V_{m1} \times (V_{m2} - v_{ref}))$

Electrical Characteristic Curves

Fig. 1 Supply Voltage vs. Supply Current

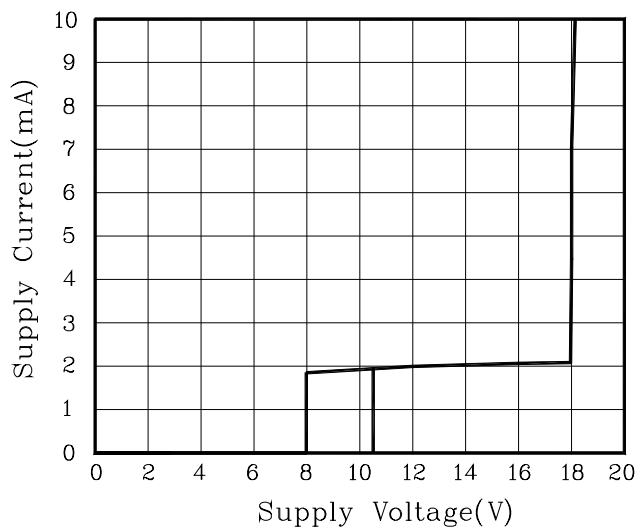

Fig. 2 Supply Voltage vs. Startup Current

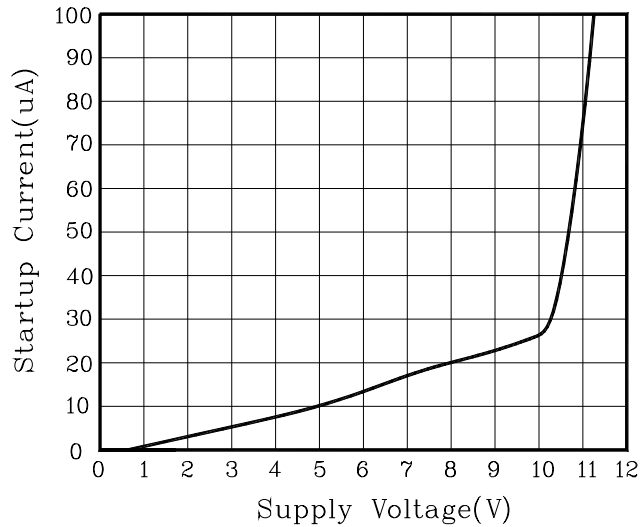

Fig. 3 Temperature vs. Voltage Feedback Input Threshold

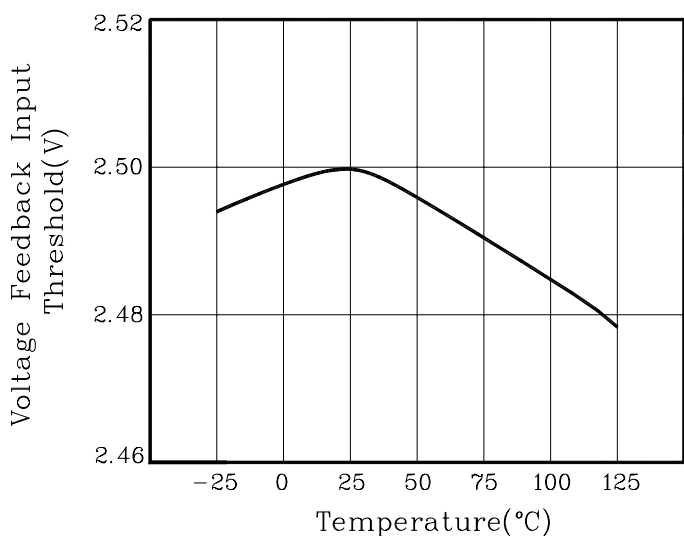

Fig. 4 Supply Voltage vs. Operating Supply Current

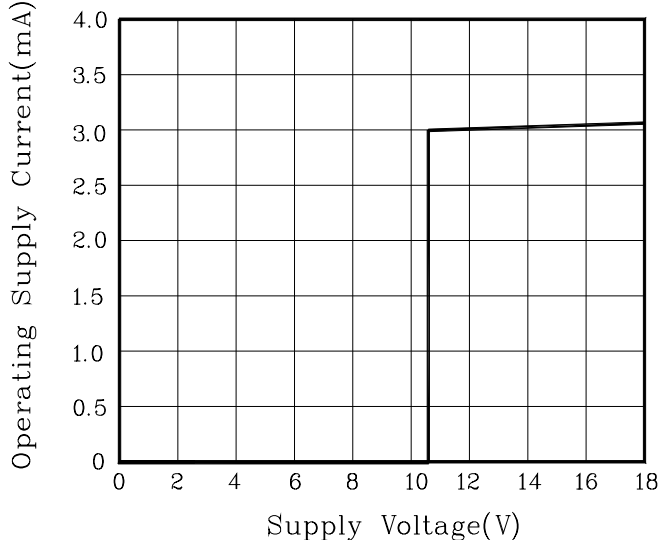

Fig. 5 Supply Voltage vs. Operating Current at OVP

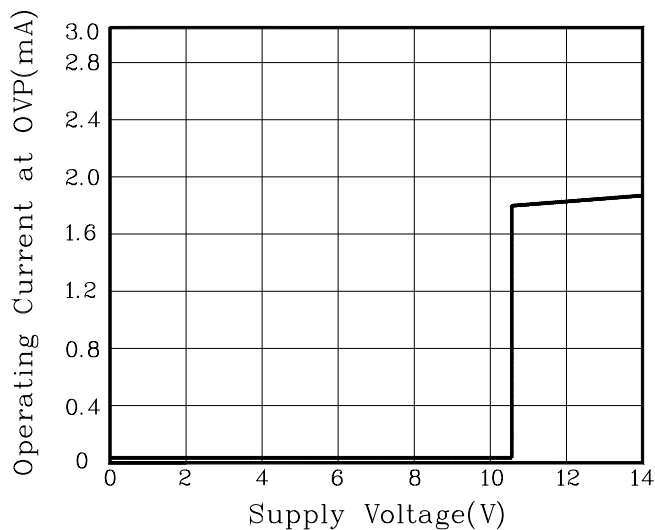
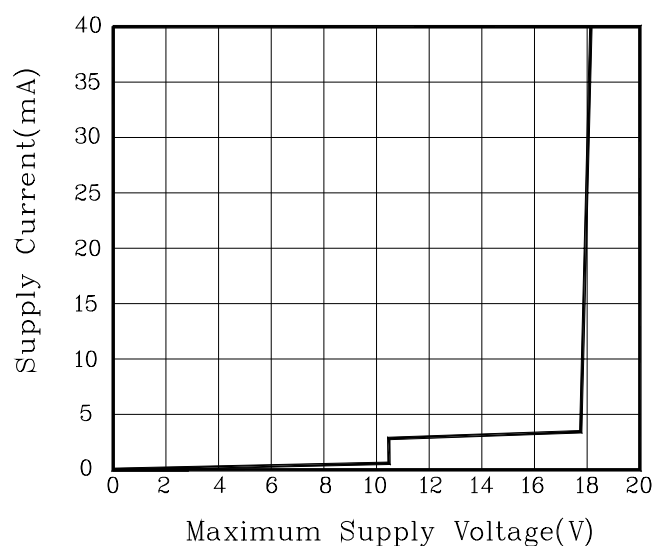

Fig. 6 Maximum Supply Voltage vs. Supply Current



Electrical Characteristic Curves

Fig. 7 Idet Input Voltage vs. Output Voltage

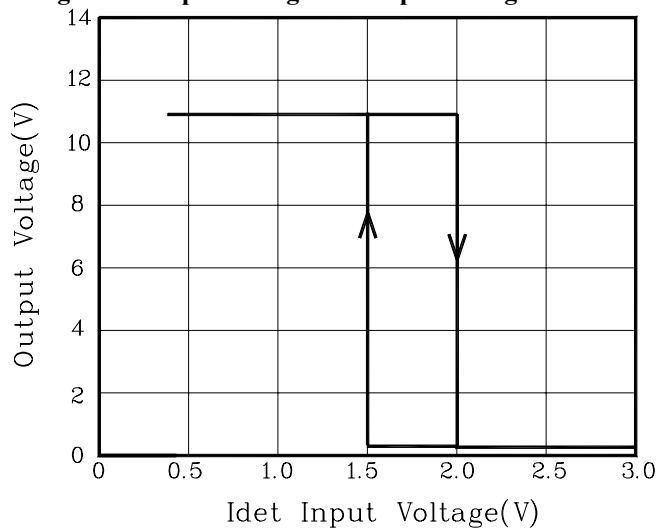

Fig. 8 Multiplier Input Voltage vs. CS Threshold Voltage

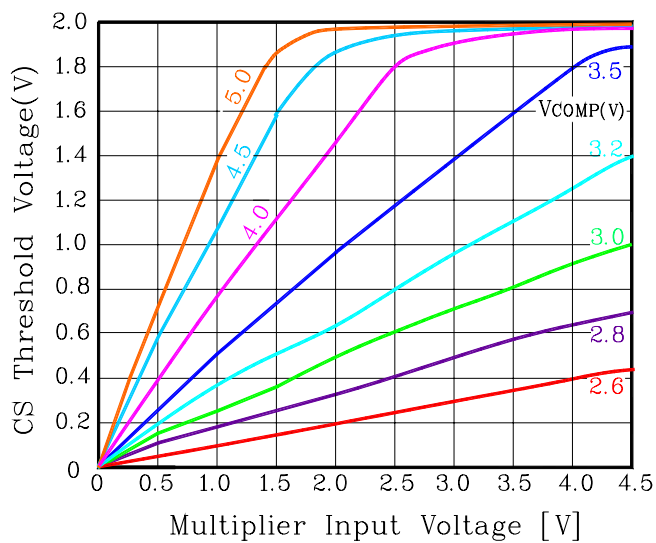

Fig. 9 Idet Input Voltage vs. Input Low Clamp Voltage

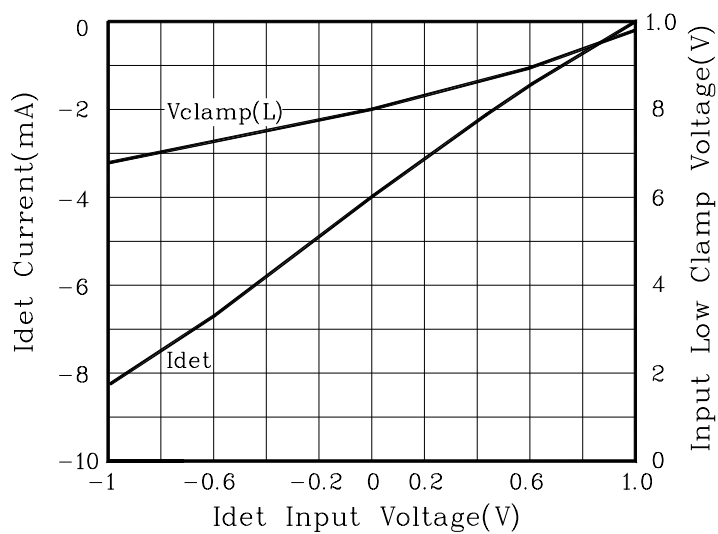
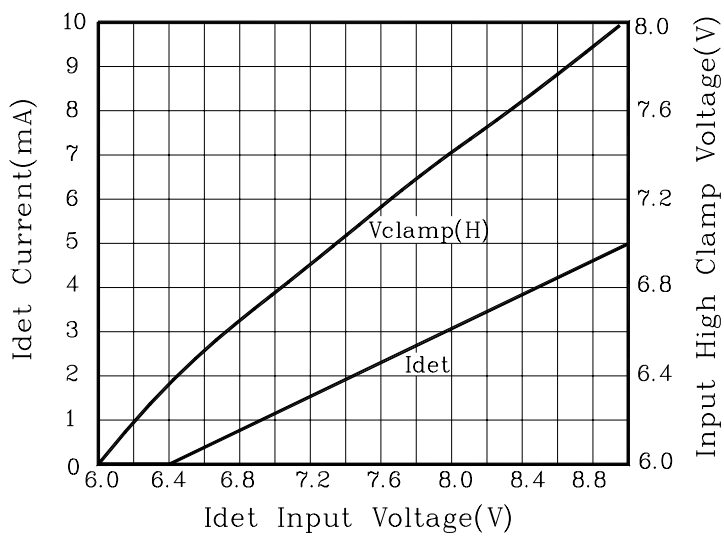

Fig.10 Idet Input Voltage vs. Input High Clamp Voltage



These AUK products are intended for usage in general electronic equipments(Office and communication equipment, measuring equipment, domestic electrification, etc.).

Please make sure that you consult with us before you use these AUK products in equipments which require high quality and/or reliability, and in equipments which could have major impact to the welfare of human life(atomic energy control, airplane, spaceship, traffic signal, combustion central, all types of safety device, etc.).

AUK cannot accept liability to any damage which may occur in case these AUK products were used in the mentioned equipments without prior consultation with AUK.