

GaAs PHEMT Switchable Gain LNA



AL108-338

Features

- For 3.2–3.8 GHz Fixed Wireless Applications
- Adjustable Gain
- +7 dBm Output Power
- +17 dBm Output IP3
- 2.7 dB Noise Figure
- Single +5 V Supply
- Input and Output Matched to 50 Ω

Description

The AL108-338 is an LNA designed for use in 3.2–3.8 GHz WLAN applications. The leadless surface mount package houses a GaAs PHEMT MMIC that yields low noise, good 50 Ω match, high gain and powerful $P_{1\text{ dB}}$ performance. Powered by a single 5 V supply, it also offers a 10 dB gain adjustment range.

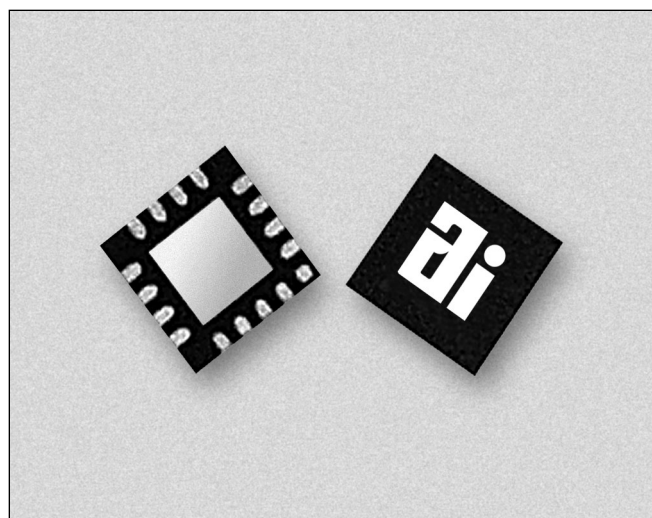

Absolute Maximum Ratings

Characteristic	Value
RF Input Power	20 dBm
Bias Voltage	6 V Max.
Storage Temperature	-40 to +85°C
Operating Temperature	-65 to +150°C

Electrical Specifications at 25°C (3.2–3.8 GHz)

Control Voltage = 0 V, Bias Voltage = 5 V, $I_D = 85\text{ mA}$

Parameter	Condition	Frequency	Min.	Typ.	Max.	Unit
Gain			19	21		dB
Output $P_{-1\text{ dB}}$				6		dBm
Output IP3	$P_{IN} = -30\text{ dBm}$		18	19		dBm
Noise Figure				2.5	2.9	dB
Reverse Isolation			30	40		dB
Input VSWR	50 Ω System			1.5:1	2.0:1	
Output VSWR	50 Ω System			1.5:1	2.0:1	

Control Voltage = 5 V, Bias Voltage = 5 V, $I_D = 85\text{ mA}$

Parameter	Condition	Frequency	Min.	Typ.	Max.	Unit
Gain			8	10		dB
Output $P_{-1\text{ dB}}$				6		dBm
Output IP3	$P_{IN} = -30\text{ dBm}$		20	23		dBm
Noise Figure				9	10	dB
Reverse Isolation			30	40		dB
Input VSWR	50 Ω System			1.5:1	2.0:1	
Output VSWR	50 Ω System			1.5:1	2.0:1	

Typical Performance Data at 25°C

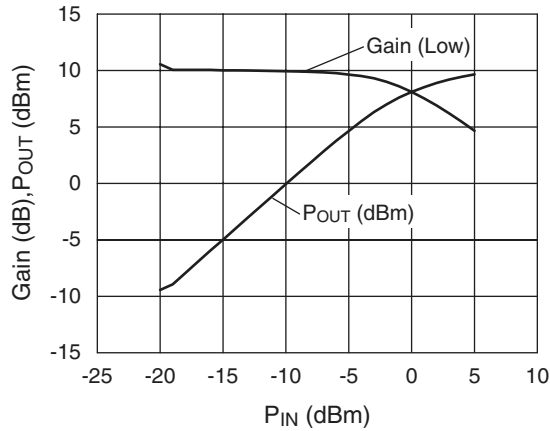

Gain and Output Power (Low Gain mode)

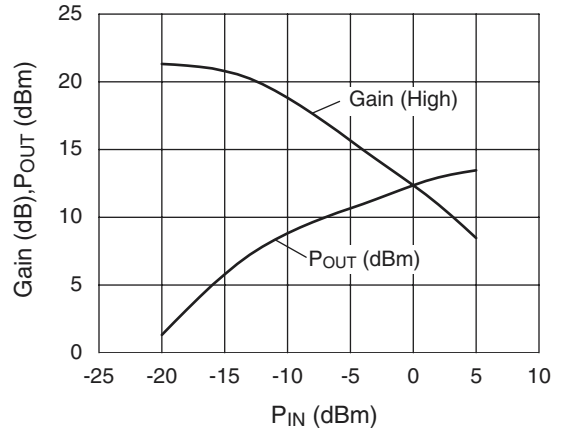

Gain and Output Power (High Gain mode)

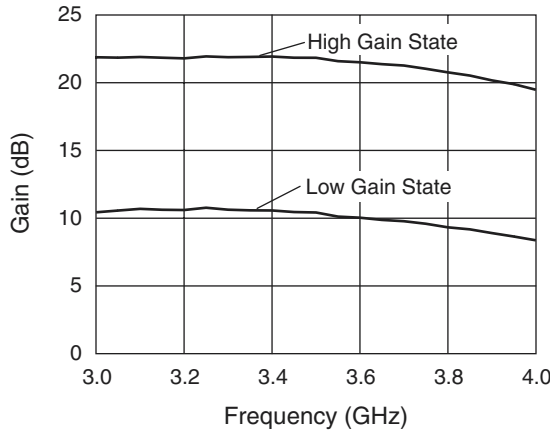

Gain vs. Frequency

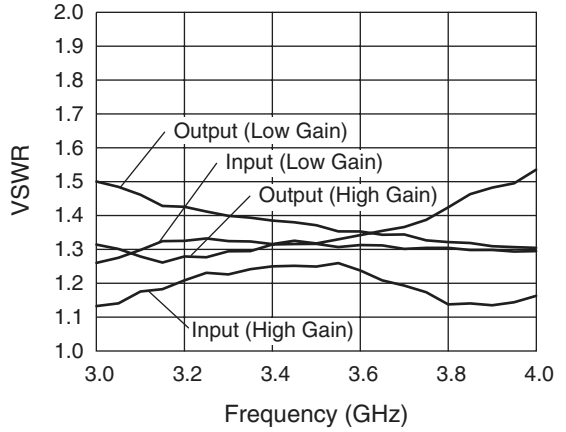

VSWR vs. Frequency

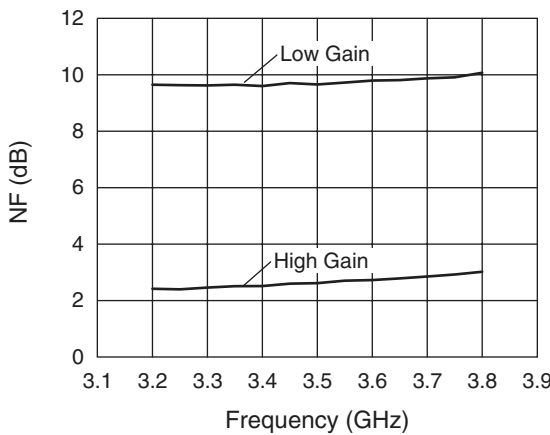

Noise Figure vs. Frequency

Evaluation Board

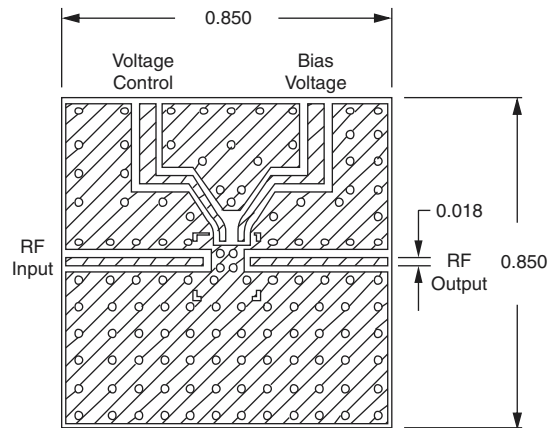

Dimensions in inches.

Pin Out (Top View)

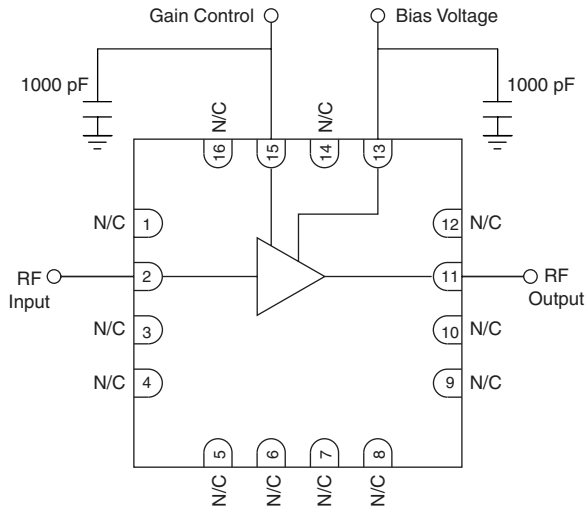

Ground is connected to paddle on bottom.

Package Outline (Bottom View)

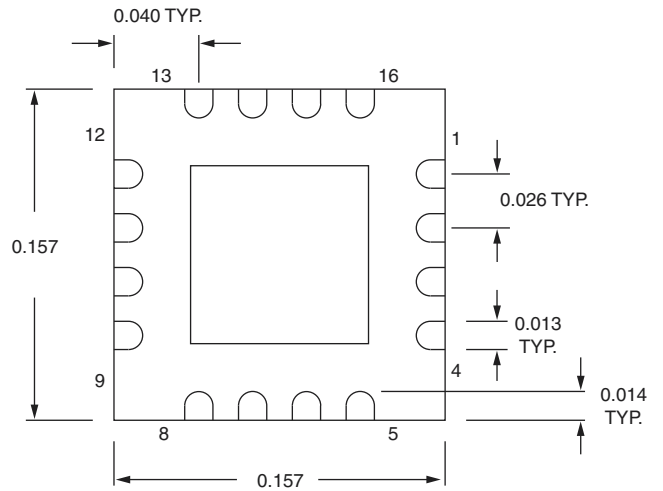

Truth Table

Low Gain	$V_C = 5\text{ V}$
High Gain	$V_C = 0\text{ V}$

Typical S-Parameters (Control Voltage 0/+5 V)

Low Gain State # GHZ S MA R 50									High Gain State # GHZ S MA R 50							
Freq. (GHz)	S ₁₁	S _{11a}	S ₂₁	S _{21a}	S ₁₂	S _{12a}	S ₂₂	S _{22a}	S ₁₁	S _{11a}	S ₂₁	S _{21a}	S ₁₂	S _{12a}	S ₂₂	S _{22a}
1.0	0.0531	65.99	0.1093	132.60	0.0081	25.28	0.2937	-93.69	0.5023	11.44	0.2221	-171.21	0.0013	-19.22	0.2935	-93.51
1.5	0.1204	91.60	0.4417	2.26	0.0054	-24.99	0.2428	-84.55	0.3677	-60.06	2.2489	65.05	0.0055	91.43	0.2265	-86.97
2.0	0.1362	14.12	1.3032	-101.06	0.0042	-17.39	0.2899	-73.12	0.4475	-131.33	10.3201	-81.96	0.0066	97.84	0.346	-60.19
2.5	0.1651	-29.48	2.5615	153.17	0.0024	11.52	0.323	-74.12	0.1954	-1.39	13.8498	143.35	0.0036	69.36	0.359	-88.94
3.0	0.1572	13.82	3.7729	53.89	0.0059	35.81	0.3019	-83.48	0.1133	-15.23	13.6149	42.94	0.0062	70.40	0.2228	-80.36
4.0	0.4082	4.29	2.9632	-128.83	0.0055	-55.78	0.0637	17.93	0.2741	-14.00	10.2202	-144.57	0.006	-16.85	0.0713	12.81
4.5	0.5055	-4.96	1.9123	157.00	0.0063	-83.69	0.267	36.24	0.324	-9.03	5.7473	131.66	0.0009	-29.68	0.2643	34.37
5.0	0.5351	-14.30	1.1534	92.88	0.0027	-148.15	0.3803	26.63	0.3458	-8.19	2.7131	59.91	0.003	-119.30	0.3786	27.80
5.5	0.4906	-31.11	0.6649	35.33	0.0062	-179.25	0.4498	21.69	0.2818	-14.80	1.1847	0.28	0.0025	-177.50	0.4481	20.63
6.0	0.2427	-72.20	0.3686	-25.59	0.0079	138.81	0.44	18.28	0.1318	34.49	0.4931	-55.56	0.0039	170.99	0.4398	18.02

Measured S-Parameters represent the packaged device.