

# GaAs IC 5 Bit Digital Attenuator

## 0.5 dB LSB Positive Control 0.5–2.0 GHz



AA106-86

### Features

- Attenuation 0.5 dB Steps to 15.5 dB with High Accuracy
- Single Positive Control (+3 to +5 V) for Each Bit
- Low DC Power Consumption
- Miniature Low Cost MSOP-10 Plastic Package

### Description

The AA106-86 is a 5 bit, single positive control GaAs IC FET digital attenuator in a low cost MSOP-10 package. This attenuator has an LSB of 0.5 dB and a total attenuation of 15.5 dB. The attenuator requires external DC blocking capacitors, positive supply voltage ( $V_S$ ) and five individual bit control voltages ( $V_1$ – $V_5$ ). The AA106-86 is particularly suited where high attenuation accuracy, low insertion loss and low intermodulation products are required. Typical applications include cellular radio, wireless data, and wireless local loop gain level control circuits.

### MSOP-10

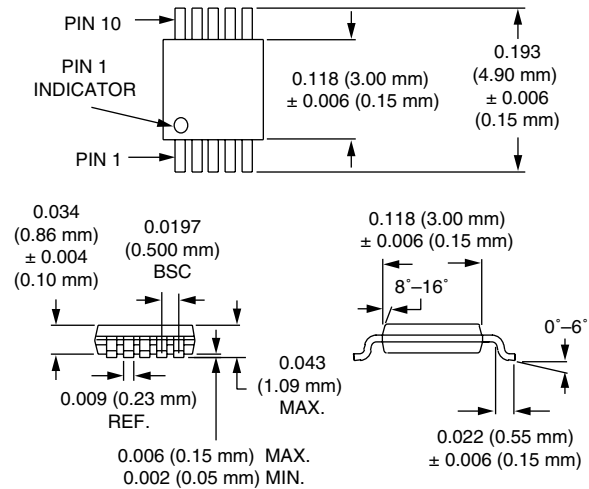

### Electrical Specifications at 25°C (0, +3 V), (0, +5 V)

Parameter <sup>1</sup>	Frequency	Min.	Typ.	Max.	Unit
Insertion Loss <sup>2</sup>	0.5–1.0 GHz		2.0	2.4	dB
	1.0–2.0 GHz		3.0	3.4	dB
Attenuation Range			15.5		dB
Attenuation Accuracy <sup>3</sup>	0.5–1.0 GHz	± (0.2 + 3% of Attenuation Setting in dB)			dB
	1.0–2.0 GHz	± (0.3 + 5% of Attenuation Setting in dB)			dB
VSWR (I/O)	0.5–2.0 GHz		1.5:1	2.0:1	

### Operating Characteristics at 25°C (0, +5 V)

Parameter	Condition	Frequency	Min.	Typ.	Max.	Unit
Switching Characteristics <sup>4</sup>	Rise, Fall (10/90% or 90/10% RF)			150		ns
	On, Off (50% CTL to 90/10% RF)			300		ns
	Video Feedthru			70		mV
Input Power for 1 dB Compression	$V_S = +3$ V	0.9–2.0 GHz		+21		dBm
	$V_S = +5$ V	0.9–2.0 GHz		+27		dBm
Intermodulation Intercept Point (IP3)	For Two-tone Input Power +5 dBm $V_S = +3$ V $V_S = +5$ V	0.9–2.0 GHz		+41		dBm
		0.9–2.0 GHz		+45		dBm
Control Voltages	$V_{Low} = 0$ to 0.2 V @ 20 $\mu$ A Max. $V_{High} = +3$ V @ 100 $\mu$ A Max. to +5 V @ 200 $\mu$ A Max. $V_S = V_{High} \pm 0.2$ V					

1. All measurements made in a 50  $\Omega$  system, unless otherwise specified.

2. Insertion loss changes by 0.003 dB/°C.

3. Attenuation referenced to insertion loss.

4. Video feedthru measured with 1 ns risetime pulse and 500 MHz bandwidth.

**Typical Performance Data (0, +5 V)**

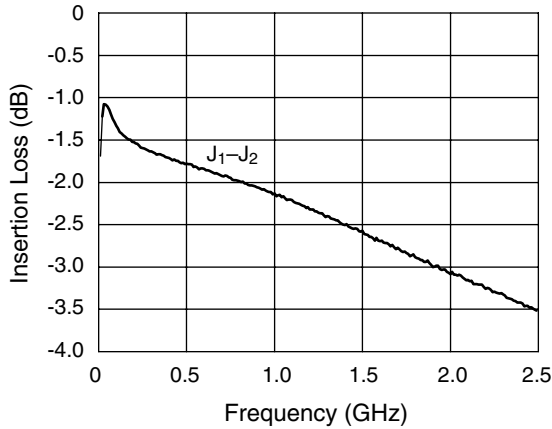

**Insertion Loss vs. Frequency**

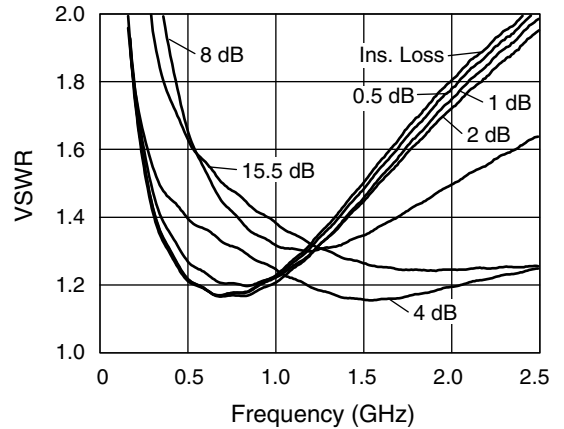

**VSWR vs. Frequency**

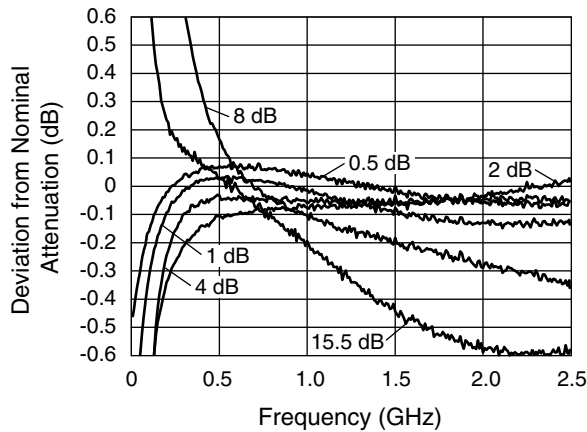

**Attenuation Accuracy vs. Frequency**

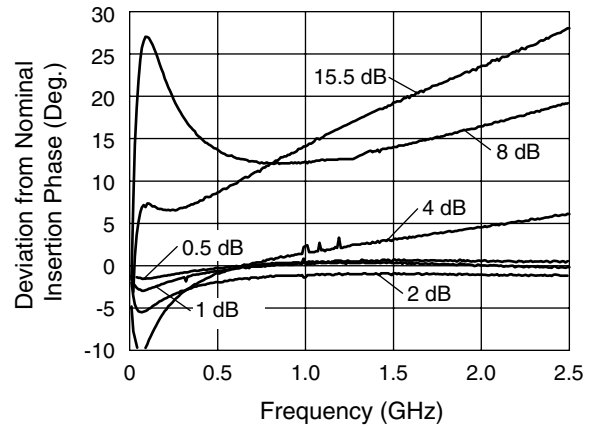

**Attenuation Phase Accuracy vs. Frequency**

**Truth Table**

V <sub>1</sub>	V <sub>2</sub>	V <sub>3</sub>	V <sub>4</sub>	V <sub>5</sub>	Attenuation J <sub>1</sub> -J <sub>2</sub>
8 dB	4 dB	2 dB	1 dB	0.5 dB	Reference I.L.
V <sub>High</sub>	V <sub>High</sub>	V <sub>High</sub>	V <sub>High</sub>	V <sub>High</sub>	0.5 dB
V <sub>High</sub>	V <sub>High</sub>	V <sub>High</sub>	V <sub>High</sub>	0	1 dB
V <sub>High</sub>	V <sub>High</sub>	0	V <sub>High</sub>	V <sub>High</sub>	2 dB
V <sub>High</sub>	0	V <sub>High</sub>	V <sub>High</sub>	V <sub>High</sub>	4 dB
0	V <sub>High</sub>	V <sub>High</sub>	V <sub>High</sub>	V <sub>High</sub>	8 dB
0	0	0	0	0	15.5 dB Max. Atten.

V<sub>High</sub> = +3 to +5 V (V<sub>S</sub> = V<sub>High</sub> ± 0.2 V).

**Pin Out**

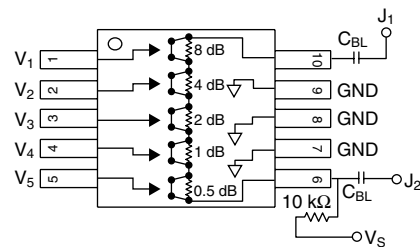

DC blocking capacitors (C<sub>BL</sub>) and biasing resistor must be supplied externally for positive voltage operation.  
C<sub>BL</sub> = 47 pF for operation >500 MHz.

**Typical Performance Data (0, +3 V)**

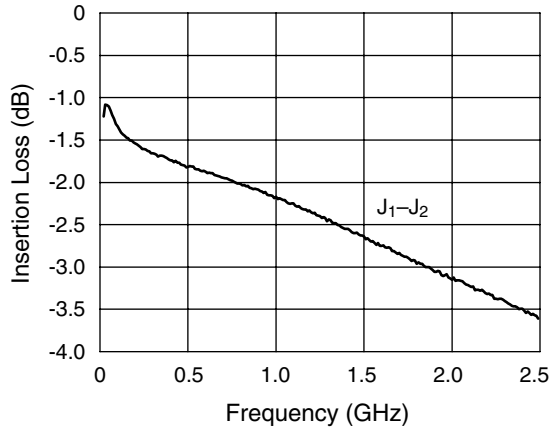

**Insertion Loss vs. Frequency**

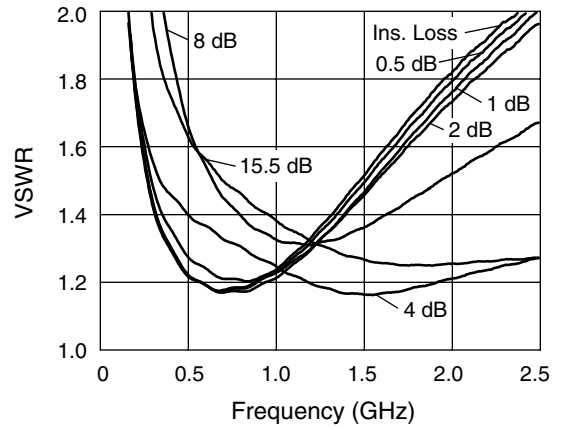

**VSWR vs. Frequency**

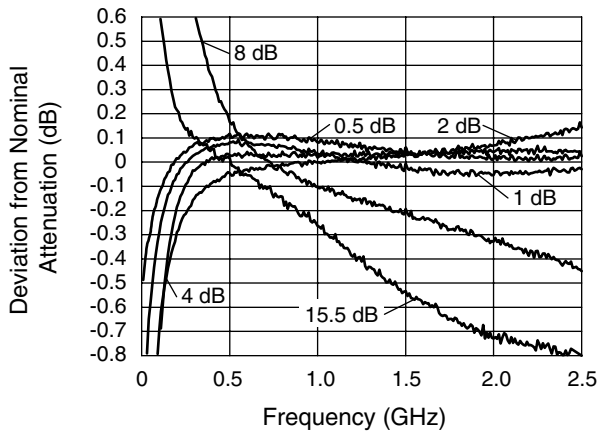

**Attenuation Accuracy vs. Frequency**

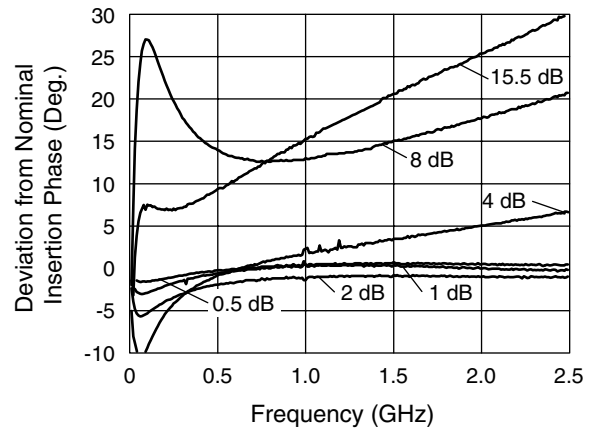

**Attenuation Phase Accuracy vs. Frequency**

**Absolute Maximum Ratings**

Characteristic	Value
RF Input Power	1 W > 500 MHz 0/8 V 0.5 W @ 50 MHz 0/8 V
Supply Voltage	+8 V
Control Voltage	-0.2 V, +8 V
Operating Temperature	-40°C to +85°C
Storage Temperature	-65°C to +150°C

Note: Exceeding these parameters may cause irreversible damage.