

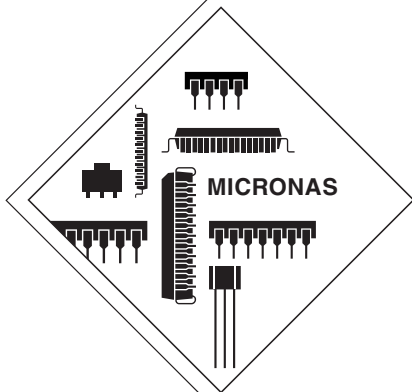

ADVANCE INFORMATION

PVP 9390A
Picture-in-Picture IC
Version A11



Contents

Page	Section	Title
4	1.	General Description
4	1.1.	Features
6	1.2.	Block Diagram
7	2.	Functional Description
7	2.1.	Analog Front-end
7	2.1.1.	Input Selection
7	2.1.2.	AD-Conversion
7	2.1.3.	Automatic Gain Control
8	2.1.4.	Signal Magnitudes
9	2.2.	Inset Synchronization
9	2.3.	Chroma Decoding And Standard Identification
10	2.4.	Comb Filtering
10	2.5.	Luminance Processing
11	2.6.	Decimation
11	2.6.1.	Single PIP Mode
11	2.6.2.	Continuos Zoom
13	2.6.3.	Horizontal And Vertical Fine Positioning
13	2.6.4.	Multi Display Mode
14	2.6.5.	Split Screen
14	2.6.6.	Multi-PIP Mode
15	2.7.	Display Control
17	2.7.1.	100 Hz Frame Mode
18	2.7.2.	Mixed Standard Applications and (S)VGA Support
19	2.7.3.	Display Standard
19	2.7.4.	Picture Positioning
20	2.7.5.	Wipe In/Wipe Out
21	2.8.	Output Signal Processing
21	2.8.1.	Luminance Peaking
21	2.8.2.	RGB Matrix
22	2.8.3.	Frame Generation And Colored Background
22	2.8.4.	16:9 Inset Picture Support
23	2.8.5.	Parent Clock Generation
23	2.8.6.	Select Signal
23	2.8.7.	Automatic Brightness Reduction
23	2.9.	On Screen Display (OSD)
23	2.9.1.	Display Format
24	2.9.2.	Character Programming
24	2.9.3.	Character and Character Background Color
24	2.10.	DA-Conversion And RGB/YUV Switch
25	2.10.1.	Pedestal Level Adjustment
25	2.10.2.	Contrast, Brightness and Peak Level Adjustment
27	2.11.	Data Slicer
27	2.11.1.	Closed Caption
27	2.11.2.	Wide-screen Signalling (WSS)
27	2.11.3.	Indication of New Data
28	2.11.4.	Violence Protection

Contents, continued

Page	Section	Title
29	2.12.	Diagrams
31	2.13.	OSD Character Set
32	3.	I²C Bus
32	3.1.	I ² C Bus Address
32	3.2.	I ² C Bus Format
33	3.3.	I ² C Bus Command Table
35	3.4.	I ² C Bus Command Description
90	4.	Specifications
90	4.1.	Outline Dimensions
91	4.2.	Pin Connections and Short Descriptions
93	4.3.	Pin Configurations
94	4.4.	Electrical Characteristics
94	4.4.1.	Absolute Maximum Ratings
95	4.4.2.	Recommended Operating Conditions
96	4.4.3.	Recommended Crystal Characteristics
97	5.	Application
97	5.1.	Application Circuit
98	6.	Data Sheet History

PVP 9390A Picture-in-Picture IC

1. General Description

The PVP 9390A is a Picture-in-Picture (PIP) processor that combines high-quality digital PIP signal processing, digital multistandard color decoding and A/D-D/A-conversion on a single chip. The device is equipped with CVBS, Y/C, and YUV input interfaces to display standard and high-quality video signals e.g. from a DVD source. The PVP 9390A replaces the Micronas PIPV Picture-in-Picture processor and provides future-proof characteristics.

The integrated digital color decoder is able to decode all analog TV standards (PAL, NTSC, and SECAM) and detects the standard automatically. Therefore, the IC is suited for world-wide use.

A picture reduction from 1/4 to 1/81 of original size, selectable in fine steps, is possible. The transfer functions of the decimation filters are optimally matched to the selected picture size reduction and can furthermore be adjusted to the viewer's requirements by a selectable peaking. A maximum of 324 luminance and 2x81 chrominance pixels per line are stored in the memory. The PIP supports split-screen applications as well as multi-PIP display.

1.1. Features

- Single-chip solution
 - A/D-conversion for CVBS or Y/C or YUV, multi-standard color decoding, PLL for synchronization of inset channel, decimation filtering, embedded memory, RGB-matrix, D/A-conversion, RGB/YUV switch, data-slicer and clock generation integrated on chip
- Analog inputs
 - 4x CVBS, 2x Y/C, 2x YUV (some inputs shared)
 - Clamping of each input
 - All ADCs with 8-bit amplitude resolution
 - Automatic Gain Control (AGC) for Y and CVBS
- Inset synchronization
 - Multiple time constants for reliable synchronization
 - Automatic recognition of 625 lines/525 lines standard
- Color decoder
 - PAL-B/G, PAL-M, PAL-N(Argentina), PAL60, NTSC-M, NTSC4.4, and SECAM
 - Adjustable color saturation
 - Hue control for NTSC
 - Automatic chroma control (–24 dB ... +6 dB)
- Automatic recognition of chroma standards: different search strategies selectable
- Single crystal for all standards
- IF-characteristic compensation filter
- Decimation
 - PIP sizes between 1/81 and 1/4 adjustable in steps of 2 lines and 4 pixel
 - Resolution up to 324 luminance and 2x81 chrominance pixels per inset line
 - Horizontal and vertical filtering dependent on picture size
 - Automatic zoom in/out possible in three speeds
- Display features
 - 7 bits per pixel stored in memory
 - Field and joint-line free frame mode display (even at 100/120 Hz AABB with picture sizes $\leq 1/9$)
 - Two “split-screen” modes with horizontal decimation of 2 and vertical of 1.5 or 1.0 (1.0 with single-scan 50/60 Hz display only)
 - POP display
 - Up to 12 pictures of 1/36th size (11 still and 1 moving)
 - Up to 6 pictures of 1/16th size (5 still and 1 moving)
 - Up to 3 pictures of 1/9th size (2 still and 1 moving)
 - Display on VGA and SVGA screen (f_H limited to 40 kHz)
 - 8 different read frequencies for 16:9 compatibility
 - Line-doubling mode for progressive scan applications
 - Freeze picture
 - Coarse positioning at 4 corners of the parent picture
 - Fine positioning at steps of 4 pixels and 2 lines
 - Wipe in/out programmable with 3 time periods
- Output signal processing
 - 7-bit DAC
 - RGB or YUV switch: Insertion of an external source without PIP processing
 - Digital interpolation for anti-imaging
 - Adjustable transient improvement for luma (peaking)
 - Contrast, brightness, and pedestal level adjustable
 - Analog outputs: Y, +(B–Y), +(R–Y), or Y, –(B–Y), –(R–Y) or RGB
 - Three RGB matrices available: NTSC(Japan), NTSC(USA), or EBU
 - 64 different background colors and 4096 different frame colors
 - Plain or 3D-frame with variable width and height

-
- Data slicing
 - Slicing of Closed Caption (CC) or wide-screen-signaling (WSS) data
 - Violence blocking capability (V-chip)
 - Several filter for XDS data extraction
 - On-screen display
 - 64 characters programmable
 - 5 characters displayed in every PIP picture or 3 rows of 20 characters each
 - 4 different character luminance values or frame color
 - 4 background luminance values or (semi-) transparent mode
 - I²C Bus control (400 kHz)
 - High-stability clock generation
 - PMQFP44-1 (lead- and halogen-free) package (SMD)
 - SDA 9488x and SDA 9588x as well as SDA 9489x and SDA 9589x software backward compatibility
 - 3.3 V and 1.8 V supply voltage

1.2. Block Diagram

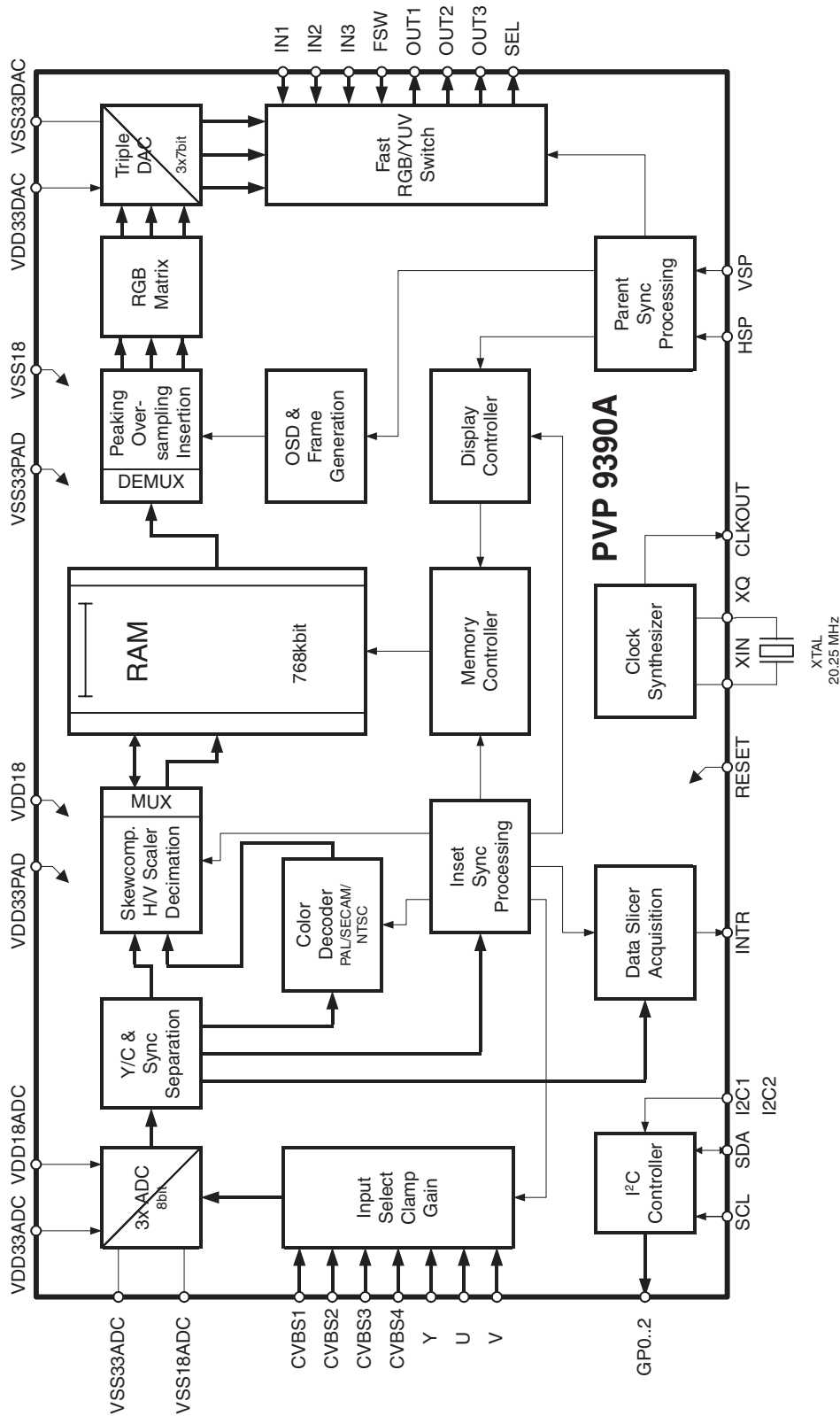

Fig. 1-1: Block Diagram

2. Functional Description

2.1. Analog Front-end

2.1.1. Input Selection

An analog inset CVBS signal can be applied to the inputs CVBS1-3 of PVP 9390A. Each of these sources is selectable via I²C bus (**CVBSEL**). Additionally CVBS4 can be enabled with **INSEL**. CVBS1/CVBS2 and CVBS2/CVBS3 can be used as separate Y/C inputs. YUV sources can be connected to CVBS1, CVBS2 and CVBS3 or to Y, U, V. The YUV source is enabled by **YUVSEL** or **INSEL**. The PVP 9390A can operate in applications with both YUV and CVBS signals without an external switch. See Fig. 2-1.

2.1.2. AD-Conversion

All signal are clamped and AD-converted with an amplitude resolution of 8 bit. CVBS and Y signals are clamped to the sync bottom or backporch, selectable by **CLMSTGY**. U/V and C signals are always clamped to their mid-level during blanking.

The clamping pulse can be shifted in position (**CLMP-IST**) and length (**CLMPID**) to adjust to the specific application. The ADCs are driven by a 20.25 MHz free running crystal clock which is not related to the incoming CVBS signal.

To avoid aliasing by sub-sampling the CVBS signal and the Y/C signals should be band-limited to 10 MHz. In the same manner the U/V signal frequency spectrum should not exceed 5 MHz. Analog anti-alias filter can be enabled for each channel. The digital filtering suppresses all frequencies above the usable spectrum.

2.1.3. Automatic Gain Control

To accommodate to different CVBS input voltages an automatic gain control has been implemented. The chip works correctly for input voltages in the range from 0.5 to 1.5 V_{pp}. For best signal-to-noise ratio, the maximum CVBS amplitude is recommended if available. The AGC behavior can be chosen out of four possibilities (**AGCMDE**).

The sync height serves as reference for the gain control in the typical application. When using overflow detection only, the gain is set to maximum and is reduced whenever an overflow occurs. This procedure will be executed again when a channel change is detected or the gain control is manually reset by **AGCRES**.

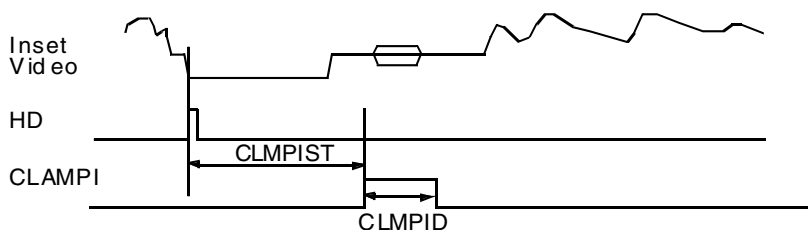

Fig. 2-1: Clamping Timing

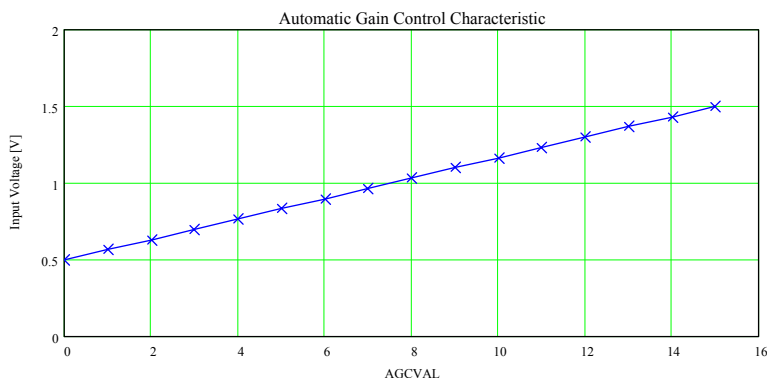

Fig. 2-2: AGC Characteristic

Table 2-1: Input selection

INSEL		CVBSEL		YUVSEL	Input						
D1	D0	D7	D6	D4	CVBS1	CVBS2	CVBS3	CVBS4	Y	U	V
0	0	0	0	0	CVBS						
0	0	0	1	0		CVBS					
0	0	1	0	0		Y _S	C				
0	0	1	1	0			CVBS				
0	0	x	x	1	Y _S	U (P _B)	V (P _R)				
0	1	x	x	x				CVBS			
1	0	x	x	x	Y _S	C					
1	1	x	x	x					Y _S	U (P _B)	V (P _R)

2.1.4. Signal Magnitudes

The nominal CVBS signal with 75 % color has a magnitude of 1 V_{pp}. The upper headroom is left to permit signals with 100 % color resulting in 1.23 V_{pp}. The Y-signal must always contain the sync part. Its levels cor-

respond to the CVBS levels except for the missing color and burst. After A/D conversion the video part is clamped to its black value and is amplified to 224 digital steps. The nominal signal levels ensure correct brightness and saturation. The YUV signal levels conform to the ITU 601 recommendation.

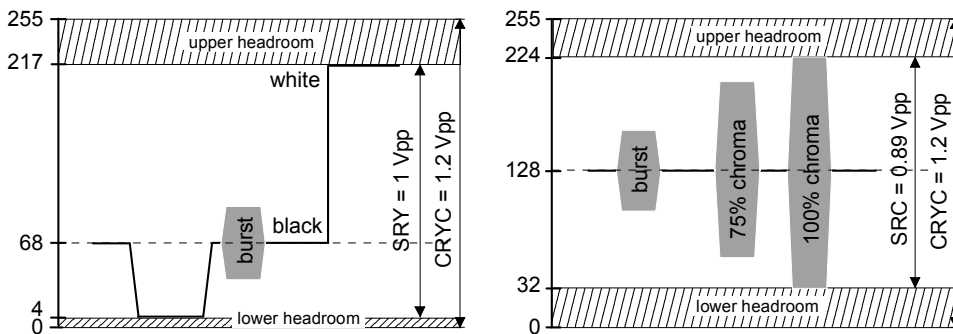

Fig. 2-3: CVBS/Y and Chroma ADC Input Signal Range

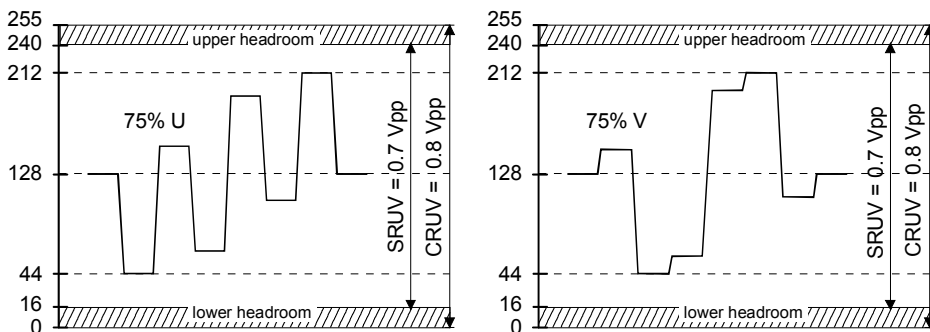

Fig. 2-4: UV Input Signal Range

Table 2–2: ADC conversion range and required input signal voltage

AGCVAL				Conversion Range CRYC	Signal Range SRY	Signal Range SRC	Conversion Range CRUV	Signal Range SRUV
D4	D3	D2	D1					
0	0	0	0	0.5 V _{pp}	0.42 V _{pp}			
...								
1	0	0	0	1.2 V _{pp}	1.0 V _{pp}	0.89 V _{pp}	0.8 V _{pp}	0.7 V _{pp}
...								
1	1	1	1	1.5 V _{pp}	1.25 V _{pp}			

2.2. Inset Synchronization

Horizontal and vertical sync pulses are separated after elimination of the high frequency components of the CVBS signal by a low pass filter. Horizontal sync pulses are generated by a digital phase-locked-loop (DPLL). Its time constant is adjustable between fast and slow behavior in four steps (**PLLITC**) to consider different input sources (e.g. VCR). Noisy input signals become more stable when a noise-reduction is enabled (**NSRED**). Additionally weak input signals from a satellite dish ('fishes') become more stable when **SATNR** is enabled. Both should be enabled to have best available performance. A vertical flywheel mode improves vertical sync separation for weak signals (**VFLYWHL**, **VFLYWHLMD**). Additionally, v-syncs may be gated by **VTHRL50/60** and **VTHRH50/60** to reject invalid v-syncs. Dependent on detected line standard, the **VTHR_x50** or **VTHR_x60** setting is used. 50 Hz or 60 Hz operation for sync separation may be forced separately or selected to work automatically (**FLNSTRD**).When **NOSIGB** is enabled, a colored background is shown instead of the picture when PIP is out of (horizontal) synchronization. The detected line standard is indicated by **SYNCSTAT**.

2.3. Chroma Decoding And Standard Identification

The system is able to decode NTSC and PAL signals with a subcarrier of 3.58 MHz and 4.43 MHz (PAL B/M/N/60, NTSC M/4.4) as well as SECAM signals with 4.05/4.2 MHz subcarrier. The system may be forced to a certain standard, or an automatic standard detection can be used (**CSTAND**). For automatic standard detection, some standards which are not likely to be received can be ignored to improve the detection process (**CSTDEX**).

Depending on the detected line standard (525 or 625 lines) the color standard detection circuit searches for 60 Hz signals (NTSC-M/PAL-M/PAL 60/NTSC44) or 50 Hz signals (PAL-B/SECAM/PAL-N) respectively. Within each line standard, the standard is detected by

consequently switching from one to another. This standard detection process can be set to slow or fast behavior (**LOCKSP**). In slow behavior, 25 fields are used to detect the standard, whereas 15 fields are used in fast behavior. If unsuccessful within this time period the system tries to detect another standard. For SECAM detection, a choice between different recognition levels is possible (**SCMIDL**, **SECACCL**, **SECDIV**) and the evaluated burst position is selectable (**BGPOS**).

For getting the chrominance information the digitized video signal is multiplied with the regenerated color subcarrier once in-phase and once phase-shifted by 90 °. After lowpass filtering digital UV is available for PAL and NTSC. The subcarrier is regenerated by a digital PLL. At SECAM operation the PLL runs free and generates the line-wise alternating subcarriers. A CORDIC structure demodulates the frequency-modulated UV signals. The following SECAM de-emphasis filter characteristic is adjustable (**DEEMP**).

The chroma signal can be filtered before demodulation by means of a selectable IF-prefilter (**IFCOMP**).

Table 2–3: Considered color standards for automatic standard detection

CSTDEX		NTSC-M	PAL60	PAL-N	PAL-M	PAL-B	SECAM	NTSC 44
D4	D3							
0	0	✓	✓			✓	✓	✓
0	1	✓		✓	✓			
1	0		✓			✓	✓	✓
1	1	✓				✓	✓	

The Hue control (**HUE**) influences the phase of the demodulation subcarrier between -44.8° and 43.4° in steps of 1.4° . This is provided for NTSC only and adjustment is ineffective for PAL and SECAM signals.

The reference for the subcarrier generation is a crystal stable clock of 20.25000 MHz. In order to avoid color standard detection problems, the maximum deviation of this frequency should not exceed 100 ppm. For a good PLL locking behavior a maximum deviation of 40 ppm is recommended. A small frequency adjustment ($-150 \dots +310$ ppm) is possible for using a crystal with small frequency deviations (**SCADJ**). For test purposes, **CPLL** allows to open the loop of the chroma PLL.

For deviations in the chroma signal up to 30 dB, a stable output amplitude after chroma decoding is achieved due to the ACC (Automatic Chroma Control). If the chroma signal (color burst) is below a selectable threshold (**CKILL**), the color will be switched off. Alternatively the color-killer can be bypassed and the color can be switched on or off under all conditions (**COLON**). By setting **ACCFIX**, the automatic chroma control is disabled and set to a default value.

The bandwidth of the chroma filter is adjustable via **CHRBW**. The bandwidth depends on whether the decoder is in SECAM operation or not. A change in **CHRBW** does not result in a chrominance position shift on the screen.

CKSTAT can be read out and gives information whether the color is switched on or off. **STDET** indicates the detected color standard. Additionally **PALID** and **PALDET** signal whether a PAL signal is applied.

Table 2–4: Color killer adjustment

CKILL		COLON	Color Killed at Clamping of
D1	D0		
0	0	0	30 dB
0	1	0	18 dB
1	1	0	24 dB
1	1	0	Color always off
X	X	1	Color always on

2.4. Comb Filtering

Depending on the selected picture size and color standard, a comb filtering is performed for luminance and chrominance. A comb filter uses the spectral interleaving of the encoded luminance and chrominance to separate both without cross artifacts. Thus cross-color and cross-luminance are suppressed effectively. For NTSC sources, a comb filtering is performed for all picture sizes. Due to reduced bandwidth in horizontal and vertical direction a strong reduction of cross artifacts can be achieved for PAL signals. The same applies for the luminance signal of SECAM signals.

2.5. Luminance Processing

The A/D-converted CVBS (or Y) signal is digitally clamped to back porch. Depending on the transmitted standard and operational area, an offset between black- and blanking level can be found in the incoming signal ('7.5 IRE'). As for some applications a black offset is not desired, controlling may be done using **LMOFST**. The positive or negative offset is added to the Y signal before scaling.

The color carrier is removed out of a CVBS signal by means of a notch filter. It is set to the corresponding color carrier (3.58 or 4.4 MHz) only if the standard is detected permanently. This prevents the luminance sharpness of being changed within the standard search process. For Y signals the notch is disabled. A special peaking can be applied to the notch-filter (**NADJ**) to make it steeper. For a fine adjustment of delay compensation between luminance and chrominance, **YCDEL** allows a luminance shifting in 16 steps of 50 ns.

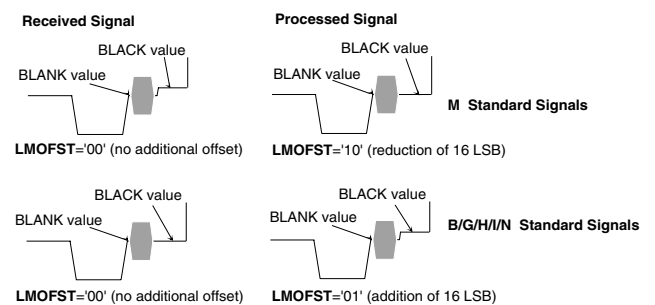

Fig. 2–5: Black Level Correction of Luminance Signal

2.6. Decimation

2.6.1. Single PIP Mode

Luminance and chrominance signals are filtered in horizontal and vertical direction. The coarse horizontal and vertical picture size (1/2, 1/3, 1/4, 1/6) is independently programmable with **SIZEHOR** and **SIZEVER**. A fine adjustment in steps of 4 pixel and 2 lines is possible by **HSHRINK** and **VSHRINK**, which allows correct aspect ratio for multistandard applications (50/60 Hz mixed mode, (S)VGA).

For main decimation factors, the stored number of pixel and lines are listed in the following tables.

Table 2-5: Number of stored pixel per line dependent on SIZEHOR

SIZEHOR		Horizontal Scaling	PIP Pixel per Line		
D3	D2		Y	(B-Y)	(R-Y)
0	0	2:1	324	81	81
0	1	3:1	216	54	54
1	0	4:1	160	40	40
1	1	6:1	108	27	27

Table 2-6: Number of stored lines per field

SIZEVER		Vertical Scaling	PIP Lines	
D1	D0		625 Lines Source	525 Lines Source
0	0	2:1	132	108
0	1	3:1	88	72
1	0	4:1	66	54
1	1	6:1	44	36

2.6.2. Continuous Zoom

The continuous zoom feature changes the picture size rapidly in an animated manner. It is available in single-PIP mode for picture sizes smaller or equal 1/4 of the undecimated picture.

There are three possibilities of using the zoom feature:

- The PIP is zoomed via **HSHRINK** and **VSHRINK** manually. This requires an I²C protocol each time the picture size should change. **CZMEN** should be used to synchronize the update of **HSHRINK/VSHRINK** with **SIZEHOR/SIZEVER**.
- A different way is to make usage of the *automatic* zooming. The zoom speed can be controlled by **CZMSP**. When switching PIP on or off by using **PIPON**, the PIP zooms automatically to the selected picture size or disappears at size of 1/81.
- A zooming between two picture sizes can be performed by changing the **HSHRINK**, **VSHRINK**, **SIZEHOR**, **SIZEVER** values, when **CZMEN** is enabled. The new picture size is obtained by zooming and not taken immediately.

Automatic zooming is only possible in *frame mode*. Being in *field mode*, the picture size remains stable until frame mode occurs or until the internal counter reaches the desired picture size. Then, the size changes immediately. Equal to the wipe process, the zooming direction depends on the coarse position (**CPOS**).

HSR NK	SIZEHOR	Decimation Factor	stored Pixel	HSR NK	SIZEHOR	Decimation factor	stored Pixel	HSR NK	SIZEHOR	Decimation factor	stored Pixel
0	0	2,00	324	0	1	3,00	216	0	3	6,00	108
1	0	2,02	320	1	1	3,04	212	1	3	6,23	104
2	0	2,05	316	2	1	3,11	208	2	3	6,48	100
3	0	2,08	312	3	1	3,17	204	3	3	6,75	96
4	0	2,10	308	4	1	3,23	200	4	3	7,04	92
5	0	2,13	304	5	1	3,29	196	5	3	7,35	88
6	0	2,16	300	6	1	3,37	192	6	3	7,70	84
7	0	2,19	296	7	1	3,44	188	7	3	8,10	80
8	0	2,22	292	8	1	3,51	184	8	3	8,52	76
9	0	2,25	288	9	1	3,60	180	9	3	8,99	72
10	0	2,28	284	10	1	3,67	176	10	3	9,51	68
11	0	2,31	280	11	1	3,76	172	11	3	10,12	64
12	0	2,35	276	12	1	3,84	168	12	3	10,64	60
13	0	2,38	272	13	1	3,94	164				
14	0	2,41	268	0	2	4,05	160				
15	0	2,45	264	1	2	4,16	156				
16	0	2,49	260	2	2	4,27	152				
17	0	2,53	256	3	2	4,38	148				
18	0	2,57	252	4	2	4,50	144				
19	0	2,61	248	5	2	4,63	140				
20	0	2,66	244	6	2	4,77	136				
21	0	2,70	240	7	2	4,91	132				
22	0	2,74	236	8	2	5,06	128				
23	0	2,80	232	9	2	5,22	124				
24	0	2,84	228	10	2	5,41	120				
25	0	2,89	224	11	2	5,59	116				
26	0	2,95	220	12	2	5,78	112				

Fig. 2-6: Number of Stored Pixel per Line Dependent on HSHR NK

		625 lines		525 lines	
VSHRNK	SIZEVER	Decimation Factor	Lines	Decimation Factor	Lines
0	0	2	132	2	108
1	0	2,03	130	2,03	106
2	0	2,06	128	2,08	104
3	0	2,09	126	2,13	102
4	0	2,13	124	2,16	100
5	0	2,16	122	2,2	98
6	0	2,2	120	2,25	96
7	0	2,23	118	2,3	94
8	0	2,28	116	2,34	92
9	0	2,31	114	2,41	90
10	0	2,36	112	2,45	88
11	0	2,41	110	2,52	86
12	0	2,44	108	2,58	84
13	0	2,48	106	2,64	82
14	0	2,53	104	2,7	80
15	0	2,59	102	2,77	78
16	0	2,64	100	2,84	76
17	0	2,69	98	2,92	74
18	0	2,75	96		
19	0	2,81	94		
20	0	2,88	92		
21	0	2,94	90		
0	1	3	88	3	72
1	1	3,07	86	3,09	70
2	1	3,14	84	3,19	68
3	1	3,21	82	3,28	66
4	1	3,3	80	3,38	64
5	1	3,38	78	3,49	62
6	1	3,47	76	3,61	60
7	1	3,56	74	3,73	58
8	1	3,66	72	3,87	56
9	1	3,77	70		
10	1	3,89	68		

		625 lines		525 lines	
VSHRNK	SIZEVER	Decimation Factor	Lines	Decimation Factor	Lines
0	2	4	66	4,01	54
1	2	4,13	64	4,15	52
2	2	4,25	62	4,31	50
3	2	4,41	60	4,5	48
4	2	4,56	58	4,69	46
5	2	4,72	56	4,9	44
6	2	4,88	54	5,13	42
7	2	5,06	52	5,39	40
8	2	5,28	50	5,7	38
9	2	5,5	48		
10	2	5,75	46		
0	3	6	44	6	36
1	3	6,28	42	6,38	34
2	3	6,61	40	6,75	32
3	3	6,94	38	7,22	30
4	3	7,31	36	7,73	28
5	3	7,78	34	8,3	26
6	3	8,25	32	9	24
7	3	8,81	30	9,8	22
8	3	9,42	28	10,78	20
9	3	10,17	26		
10	3	11,02	24		

Fig. 2-7: Number of Stored Lines per Field Dependent on VSHRNK

2.6.3. Horizontal And Vertical Fine Positioning

All picture sizes are pre-centered inside the frame. In addition, if necessary the vertical and horizontal acquisition area can be shifted by **VFP** for vertical and **HFP** for horizontal direction.

2.6.4. Multi Display Mode

The PVP 9390A offers the feature to display a sub-picture more than once. The picture size and arrangement depends on the display mode (**DISPMOD**) and not on **SIZEHOR** or **SIZEVER**. Hence variable scaling is not possible in these modes.

The display modes are shown in the appendix. The sizes of the partial pictures are listed in Table 2.7. on page 15

Table 2–7: Multi-display modes

Display Mode	DISPMOD		Size	Picture Configuration	Pixel	Lines	
	D6	D5				625	525
1	0	0	SIZEHOR/SIZEVER HSRHNK/VSHRNK	Single PIP mode	324 60	132 24	108 20
2	0	1	3 X 1/9	One upon another (same content)	216	264	216
3	1	0	4 X 1/16	One upon another (same content)	156	264	216

2.6.5. Split Screen

For split screen applications two selectable “double window” modes in which one half of the picture is generated by the PVP 9390A can be used. The split screen mode can be selected by two possible combinations of **DISPMOD**.

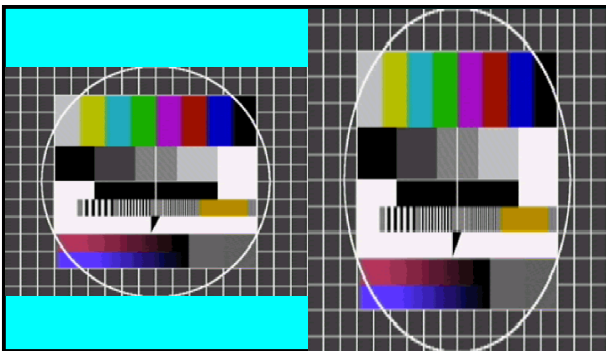

Fig. 2–8: Double Window Mode 1.5 (left picture) and Mode 1 (right picture)

The D1.5 mode is suited for displaying split screen on 16:9 tubes keeping the aspect ratio. The DW1 format covers the full height of the screen. The DW1 format is only suited for 50/60 Hz single-scan applications and is not suited for 100 Hz or “progressive” displays.

2.6.6. Multi-PIP Mode

There is a great variety of multi-PIP modes available. Up to 11 different still pictures and one moving picture can be shown. This is useful to give an overview over broadcasted programmes (e.g. tuner-scan) or for supervising purposes. For multi-PIP modes only three fixed picture sizes are available (1/9, 1/16 or 1/36). The picture size and arrangement depends on the display mode (**DISPMOD**) and not on **SIZEHOR** or **SIZEVER**. Variable scaling is thus not possible in these modes. Because of limited memory capacity, the number of frozen multi-pictures is limited dependent on picture size to the number shown in the table below:

Table 2–8: Maximum number of pictures in multi-PIP mode

Picture Sizes	Maximum Number of Pictures (Including One Live Picture)
1/9	3
1/16	6
1/36	12

The partial picture that is written is addressed via **WRPOS**. With **INFRM**, a frame for separation of every PIP can be selected. This is adjustable to single or dual PIP mode (**INFRMOD**). The current updated picture can be highlighted with **PIPHLT**. To avoid garbage pictures after switching from one mode to another the selected picture can be blanked with **PIPBLK**. **MPIPBG** defines whether the picture will be blanked with black or with the adjusted background color.

For compatibility reasons to other devices, the **DISPMOD** register is split into two segments. If a display mode is chosen that is not implemented, the PIP insertion is switched off automatically (**PIPON** = ‘0’). The sizes of the partial pictures correspond to the sizes of the inset pictures of the single PIP modes.

Table 2–9: Display Modes

Display Mode	DISPMOD					Size	Picture Configuration	Pixel	Lines	
	D6	D5	D4	D3	D2				625	525
4	0	0	0	0	1	2 x 1/9,	One upon another	216	176	144
5	0	0	0	1	0	2 x 1/9,	Side by side	432	88	72
6	0	0	0	1	1	3 x 1/9,	Side by side	648	88	72
7	0	0	1	0	0	3 x 1/9	Pne upon another	216	264	216
8	0	0	1	0	1	4 x 1/16	Side by side	624	66	54
9	0	0	1	1	0	6 x 1/16	Inverted U shaped	624	132	108
10	0	0	1	1	1	6 x 1/16	U shaped	624	132	108
11	0	1	0	0	0	4 x 1/16	2 rows of 2 pictures	312	132	108
12	0	1	0	0	1	4 x 1/16	One upon another	156	264	216
13	0	1	0	1	0	12 x 1/36	6 rows of 2 pictures	216	264	216
14	0	1	0	1	1	12 x 1/36	2 rows of 6 pictures	648	88	72
15	0	1	1	0	0	9 x 1/36	3 rows of 3 pictures	324	132	108
16	0	1	1	0	1	12 x 1/36	3 rows of 4 pictures	432	132	108
17	0	1	1	1	0	11 x 1/36	Angular of 11 pictures	648	264	216
18	0	1	1	1	1	9 x 1/36	Angular of 9 pictures	540	220	180
19	1	0	0	0	0	1 x 1/3	Double Window (V=1.5)	324	176	144
20	1	0	0	0	1	1 x 1/2	Double Window (V=1) ¹⁾	324	264	216
21	1	0	0	1	0		OSD only			
	Others						Reserved			

¹⁾ Single-scan display only

2.7. Display Control

The on-chip memory capacity is 768 kbits. Provided that the same standard (50 or 60 Hz) video sources are applied to inset and parent channel, joint-line free frame mode display is possible. This means that every incoming field is processed and displayed by the PVP 9390A processors. The result is a high vertical and time resolution. For this purpose the standard is analyzed internally and the frame mode display is blocked automatically, if the described restrictions are not fulfilled. Then, only every second incoming field is shown (field mode). Field mode normally shows joint-lines. This is caused by an update of the memory during read out. The result is that one part of the picture contains new picture information and the other part

contains one earlier written field. The switching from or to frame mode is free of artifacts.

Activation of frame-mode display is blocked automatically when at least one of the following conditions is not fulfilled:

- Inset and parent channel have the same field repetition frequency. This means that frame mode is possible only for 50 Hz inset and parent sources or 60 Hz inset and parent sources.
- Interlace signal is detected for inset and parent channel. Therefore, for progressive scan or (S)VGA display, only field mode is possible. For some VCRs in trick mode, often no interlace is detected.

- The number of lines is within a predefined range for inset (**FMACTI**) or parent (**FMACTP**) channel (assuming standard signals according to ITU)

The system may be forced to field mode by means of **FIESSEL**. Either first or second field is selectable. "One of both" takes every second field independent of the field number. This is meant for sources generating only one field (e.g. video-games).

For progressive scan conversion systems and HDTV/(S)VGA displays a line doubling mode is available (**PROGEN**). Every line of the inset picture is read twice.

Memory writing is stopped by **FREEZE** bit. The field stored in the memory is then continuously read. As the picture decimation takes place before storing, the picture size of a frozen picture can not be changed.

Synchronization of memory reading with the parent channel is achieved by processing the parent horizontal and vertical synchronization signals connected to the pin HSP for horizontal synchronization and pin VSP for vertical synchronization. **HSPINV** or **VSPINV** respectively allow an inversion of the expected signal polarity.

Table 2-10: Required number of lines for frame mode display

FMACTP	Parent Standard	Number of Lines per Field	FMACTI	Inset Standard	Number of Lines per Field
D3			D6		
0	50 Hz	310...315	0	50 Hz	310...315
1	50 Hz	290...325	1	50 Hz	290...325
0	60 Hz	260...265	0	60 Hz	260...265
1	60 Hz	250...275	1	60 Hz	250...275

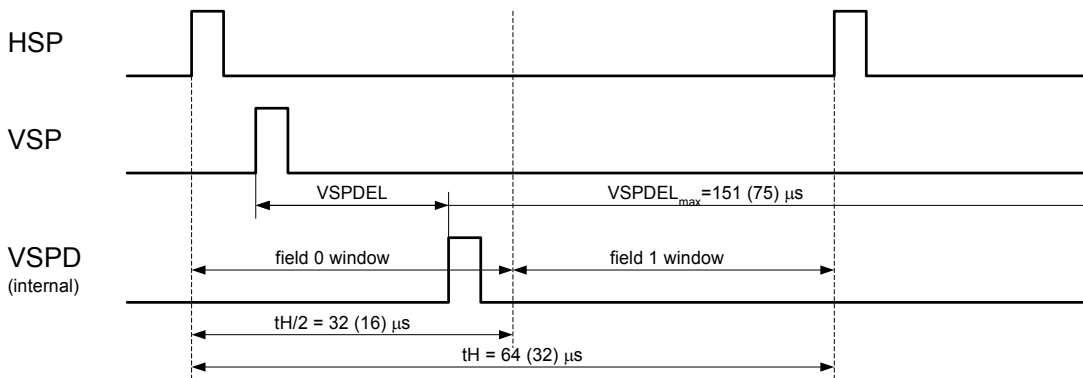

values in brackets () apply for 100Hz systems

Fig. 2-9: Field Detection and Phase Adjustment of Vertical Pulse (VSP)

Depending on the phase between inset and parent signals a correction of the display raster for the read out data is performed. As the external VSP and HSP signals may come from different devices with different delay paths, the phase between V-sync and H-sync is adjustable (**VSPDEL**). An incorrect setting of **VSPDEL** may result in wrong or unreliable field detection of parent channel.

Normally a noise reduction of the incoming parent vertical pulse is performed. With this function missing ver-

tical pulses are compensated. The circuit works for 50/60 Hz applications as well as progressive and 100/120 Hz application. (S)VGA signals are supposed to be very stable and therefore not supported by the noise suppression. By means of **VSPNSRQ**, vertical noise suppression is switched off.

A great variety of combinations of inset and parent frequencies are possible. Table 2-11 on page 17 shows some constellations.

2.7.1. 100 Hz Frame Mode

If the picture size is smaller or equal than 1/9 PIP a true frame mode display for 100 Hz parent standard with a double field repetition rate is possible (display raster $\alpha\alpha\beta\beta$ only). The picture size is indicated by the horizontal and vertical decimation factors that must be equal or below 1/3 of undecimated picture size in both directions. This guarantees enough memory for a joint-line free picture with full vertical resolution. For bigger

pictures only field mode is supported. The 100 Hz frame mode is activated if **READD='1'** for the above mentioned picture sizes. For an acceptable quality without line flicker or motion artifacts only the mode $\alpha\alpha\beta\beta$ is supported for HSP and VSP. If the sequence $\alpha\beta\alpha\beta$ is detected, the field mode will be activated again. Continuous switching between these modes is possible, resulting in continuous switching between field- and frame mode.

Table 2–11: Available features with varying inset and parent standards

Inset Frequency ¹⁾	Parent Frequency ¹⁾ (HSP/VSP)	Frame Mode	Correct Aspect Ratio (Single PIP)	Correct Aspect Ratio (Multi Display)	Vertical Noise Suppression Selectable
50	50i	✓	✓	✓	✓
50	60i		✓		✓
60	50i		✓		✓
60	60i	✓	✓	✓	✓
50	50p		✓	✓	✓
50	60p		✓		✓
60	50p		✓		✓
60	60p		✓	✓	✓
50	100i	✓ ¹⁾	✓	✓	✓
50	120i		✓		✓
60	100i		✓		✓
60	120i	✓ ²⁾	✓	✓	✓
50	(S)VGA		✓	✓ ¹⁾	
60	(S)VGA		✓	✓ ³⁾	

1) Standard signals supposed
 2) AABB only and picture size smaller than 1/9
 3) Valid for some parent frequencies. Please refer to **Chapter 2.7.2.**

2.7.2. Mixed Standard Applications and (S)VGA Support

Table 2–12: Examples of supported parent signals

Remark ($N_{\text{apel}} \times N_{\text{aline}} @ f_V$)	f_H (kHz)	T_H (μs)	$T_{H\text{act}}$ (μs)	Lines/ Active	f_{dot} (MHz)	Scan	Correct Aspect Ratio
720 x 576@50 Hz (TV)	15.6	64.0	52.0	625/576	13.5	Interlace	✓
702 x 488@60 Hz (TV)	15.7	63.6	52.7	525/488	13.5	Interlace	✓
720 x 576@100 Hz (TV 100 Hz)	31.2	32.0	26.0	625/576	27	Interlace	✓
702 x 488@120 Hz (TV 120 Hz)	31.2	31.8	26.4	525/488	27	Interlace	✓
720 x 576@50 Hz (TV progressive)	31.2	32.0	26.0	625/576	27	Progressive	✓
702 x 488@60 Hz (TV progressive)	31.2	31.8	26.4	525/488	27	Progressive	✓
640 x 480@60 Hz (VGA)	31.5	31.8	25.4	525/480	25.2	Progressive	✓
640 x 480@72 Hz (VGA)	37.9	26.4	20.3	520/480	31.5	Progressive	✓
640 x 480@75 Hz (VGA)	37.5	26.7	20.3	500/480	31.5	Progressive	✓
800 x 600@56 Hz (SVGA)	35.2	28.4	22.2	625/600	36.0	Progressive	✓
800 x 600@60 Hz (SVGA)	37.9	26.4	20.0	625/600	40.0	Progressive	
800 x 600@72 Hz (SVGA)	48.1	20.8	16.0	666/600	50.0	Progressive	
800 x 600@75 Hz (SVGA)	46.9	21.3	16.2	625/600	49.5	Progressive	
800 x 600@85 Hz (SVGA)	53.7	18.6	14.2	631/600	56.3	Progressive	
1024 x 768@43 Hz (SVGA)	35.5	28.2	22.8	817/768	44.9	Interlace	

The PVP 9390A allows multiple scan rates for the use in desktop video applications, VGA compatible or 100 Hz TV sets. All features are provided in “normal” operating modes at auto detected 50 Hz and 60 Hz parent and inset standards. $2f_H$ modes (100/120 Hz and progressive) are supported by line frequency- and pixel clock doubling and are not detected automatically. Even on a 16:9 picture tube correct aspect ratio can be displayed by selecting the suitable parent clock. The video synthesizer generates also a special pixel clock for VGA display (see chapter 5.5.9 for details). As (S)VGA consists of a variety of scan rates the correct aspect ratio is not adjustable for all modes with the parent clock (**HZOOM**) because of the limited count of frequencies. For single PIP only, correct aspect ratio is maintained by the vertical and horizontal scaler (**HSHRINK** and **VSHRINK**).

It is possible to display (S)VGA sources for parent display, as long as the horizontal frequency is lower than 40 kHz and the signal does not contain more than 1023 lines. For progressive scan mode, **PROGEN** must be set. Additionally *field-mode* should be forced

to prevent not allowed *frame-mode* displaying (**FIESEL**). As the (S)VGA normally does not fit to the display raster generated in the vertical noise suppression, **VSPNSRQ** should be disabled. (S)VGA signals for inset channel are not supported.

Table 2–13: Selection of display field repetition

READD	PROGEN	Expected Input Signal
D3	D2	
0	0	50 or 60 Hz Signal Interlace
1	0	100 or 120 Hz Signals Interlace
0	1	(Reserved)
1	1	50 or 60 Hz or (S)VGA Signal Progressive

2.7.3. Display Standard

For a single-PIP, the number of displayed lines depends on the selected picture size and on the signal standard. For multi picture display, the number of displayed lines depends on the selected picture size and on the signal standard of the parent signal. Additionally, a standard can be forced by **DISPSTD**. See table 2-14.

When a 625 lines picture is shown with a 525 lines parent signal, some lines are missing on top and bottom of picture. When a 525 lines picture is shown with a 625 lines display standard, missing lines at top and bottom are filled with background color or black depending on **MPIPBG**. See Fig. 2-10.

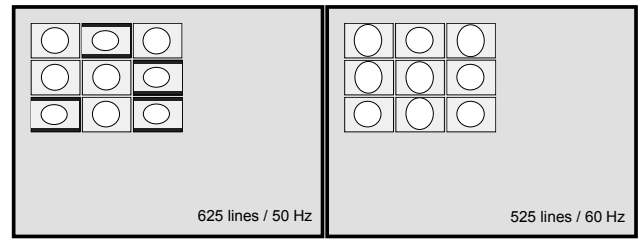

Fig. 2-10: 50 and 60 Hz Multi PIP Display on 50 Hz and 60 Hz Display

Table 2-14: Display standard selection

DISPSTD		DISP MOD	Display Standard
D7	D6		
0	0	0	PIP depends on detected inset standard (single PIP)
0	0	>0	PIP depends on detected parent standard (multi display)
0	1	x	PIP display is always in 625 lines mode
1	0	x	PIP display is always in 525 lines mode
1	1	x	Freeze last detected display standard and size

2.7.4. Picture Positioning

The display position of the inset picture is programmable to the 4 corners of the parent picture (**CPOS**). From there PIP can be moved to the middle of the TV Picture with **POSHOR** and **POSVER**. The corner positions can be centered coarsely on the screen with **POSOFH** and **POSOFV**. Depending on coarse position, one PIP corner remains stable when changing the picture size.

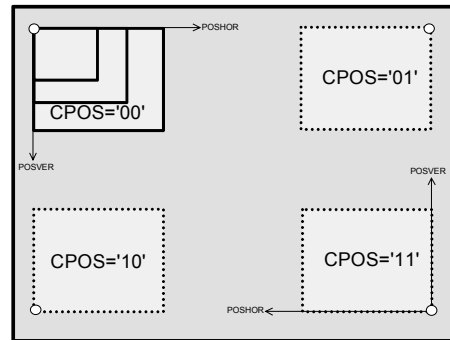

Fig. 2-11: Coarse Positioning

There are 256 horizontal locations (4 pixel increments) and 256 vertical locations (2 line increments). The pixel width on the screen depends on the selected **HZOOM** factor. Even POP-positions (Picture Outside Picture) in 16:9 applications are possible.

Table 2-15: Coarse Positioning

CPOS		Coarse Position	Reference Corner of PIP	Increasing POSVER	Increasing POSHOR
D6	D5				
0	0	Upper left	Upper left	Down	Right
0	1	Upper right	Upper right	Down	Left
1	0	Lower left	Lower left	Up	Right
1	1	Lower right	Lower right	Up	Left

2.7.5. Wipe In/Wipe Out

With the wipe in/wipe out function it is possible to let appear or disappear the complete inset picture starting or ending at the corner of the inset picture position defined by **CPOS**. Thereby the size of the visible picture-part is continuously increased and decreased respectively. During this procedure the frame is shown with its chosen widths. 3 different wipe in/out time periods or “no wipe” are programmable via **WIPESP**. The wipe algorithm always works in horizontal and vertical direction.

If **WIPESP** is set accordingly, **PIPON** controls the wipe operation. When **PIPON** changes the wipe operation starts. During this period, the readable **PIPSTAT** indicates the ongoing wipe-process. A transition of **PIPON** from ‘0’ to ‘1’ triggers the wipe-in. The wipe-in process stops when the picture reaches its programmed size. When **PIPON** changes from ‘1’ to ‘0’ the wipe-out starts. The wipe-out is finished when the PIP picture vanishes. Even for multi-picture display wipe operation is possible. A change of **PIPON** or **WIPESP** during wipe operation has only an effect after the wipe operation has been finished.

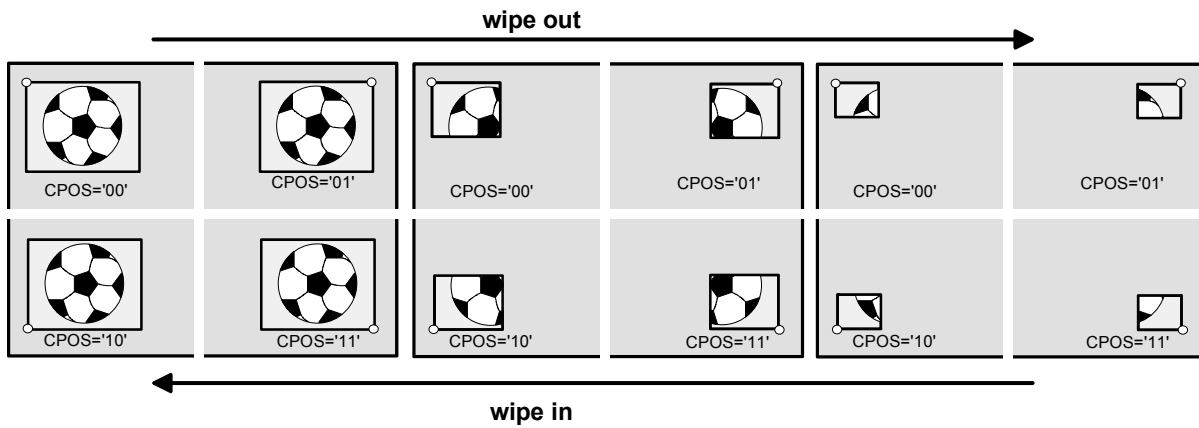

Fig. 2-12: Wipe Display

2.8. Output Signal Processing

2.8.1. Luminance Peaking

To improve picture sharpness, a peaking filter which amplifies higher frequencies of the input signal is implemented. The amount of peaking can be varied in seven steps by **YPEAK**. The setting '000' switches off the peaking. The value '011' is recommended as this value provides a good compromise between sharpness impression and annoying aliasing. The characteristic for all possible settings is shown in Fig. 2–13. The emphasized frequency depends on the adjusted decimation. The gain maximum is always located before the band-limit ensuring optimal picture impression. Peaking can be additionally increased by **PKBOOST**.

Coring should be switched on by **YCOR** to reduce noise, which is also amplified when peaking is enabled. As the coring stage is in front of the peaking filter, 1 LSB noise will not be peaked.

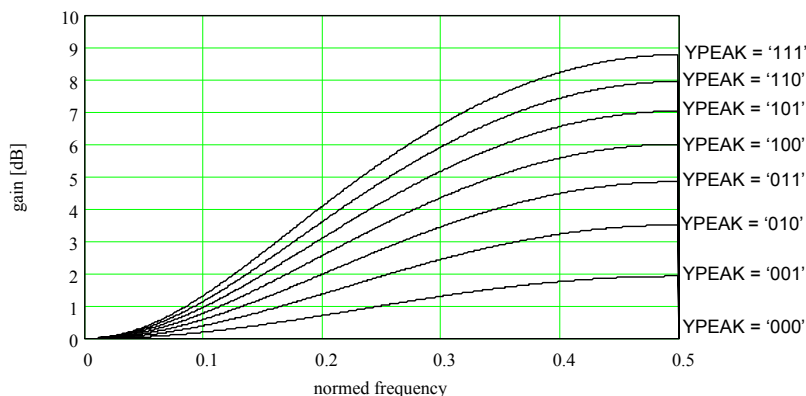

Fig. 2–13: Characteristics of Selectable Peaking Factors (0.5 = band limit)

2.8.2. RGB Matrix

The chip contains three different matrices, one suited for EBU standards, one suited for NTSC-Japan and one suited for NTSC-USA, which are selected via **MAT**. The signal **OUTFOR** switches between YUV output or RGB output. The signal **UVPOLAR** inverts the U and V channels and results in Y-U-V output. The standard magnitudes and angles of the color-difference signals in the UV-plane are defined as shown in Table 2–16.

The color saturation can be adjusted with **SATADJ** register in 16 steps between 0 and 1.875. Values above 1.0 may clip the chrominance signals.

Table 2–16: RGB matrices characteristics

MAT		Magnitudes			Angles			Standard
D7	D6	(B-Y)	(R-Y)	(G-Y)	(B-Y)	(R-Y)	(G-Y)	
0	0	2.028	1.14	0.7	0	90	236	EBU
0	1	2.028	1.582	0.608	0	95	240	NTSC (Japan)
1	0	2.028	2.028	0.608	0	105	250	NTSC (USA)
1	1							(Reserved)

2.8.3. Frame Generation And Colored Background

With FRWIDTH and FRWIDV different to '0', a colored frame is shown. With FRSEL a shaded frame is displayed.

Note: If FRSEL is on, a shaded frame is shown, even if FRWIDTH and FRWIDV is '0'. Therefore, if no frame is required, FRSEL as well as FRWIDTH and FRWIDV must be set to '0'.

The chip can display two different types of frames, one simple monochrome frame and a more sophisticated frame giving a three dimensional impression.

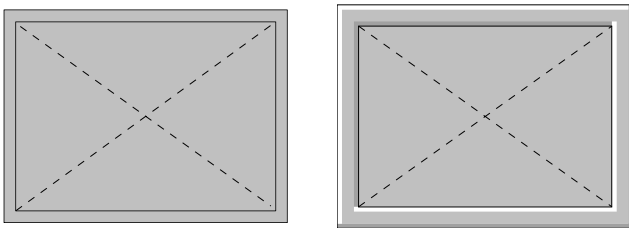

Fig. 2-14: Normal Frame and 3D Frame

The frame elements are always placed outside the inset picture, except for the inner shade of three dimensional frame or inner frame in multi-PIP mode. There is no shift of the inset picture position if the inset frame width is modified.

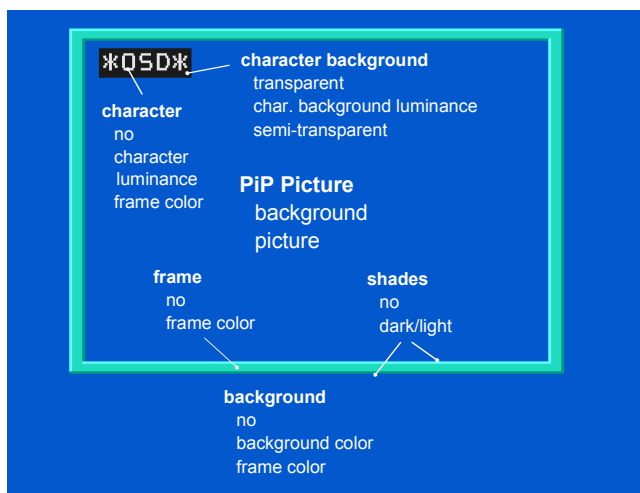

Fig. 2-15: Selectable Picture Configurations

A total of 4096 frame colors are programmable by **FRY**, **FRU**, and **FRV**, 4 bits for each component. Horizontal and vertical width of the frame are programmable independently by **FRWIDTH** and **FRWIDV**. If desired, frame color is displayed over the whole PIP size or whole picture size of the main channel when **PIPBG** is set accordingly. 64 background colors are programmable by **BGY**, **BGU**, **BGV**, 2 bits for each component. Alternatively **BGFRC** sets the background to frame color.

2.8.4. 16:9 Inset Picture Support

To remove dark stripes at 16:9 inset pictures the vertical display area is shrinkable with **VPSRED**. The number of omitted lines depends on the vertical decimation factor.

Table 2-17: Number of lines with and without reduction of vertical picture size

Vertical Decimation Factor	Displayed Lines			
	50 Hz		60 Hz	
	With	Without Reduction	With	Without Reduction
1	214	264	175	216
...				
6	35	44	29	36

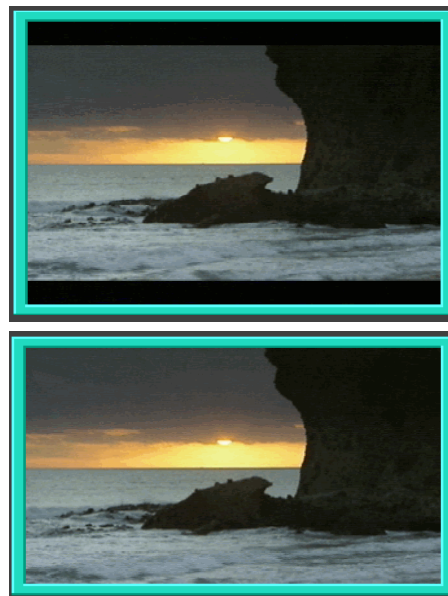

Fig. 2-16: 16:9 Inset Picture without and with Reduction of Vertical Picture Size

2.8.5. Parent Clock Generation

Table 2–18: Format conversion using HZOOM

Display Format	Inset Picture Format	Desired PIP Format	Required Parent Frequency	Value of HZOOM		
				D2	D1	D0
4:3	4:3	4:3	27	0	0	0
4:3	4:3	16:9	20.25	0	0	1
16:9	4:3	4:3	36	0	1	0
16:9	16:9	16:9	36	0	1	0

The phase of the output signals is locked to the rising edge of the horizontal sync pulse. The frequency can be varied in a certain range to ensure correct aspect ratio for 16:9 applications depending on **HZOOM**. The horizontal and vertical scaling can be used for all display frequencies.

2.8.6. Select Signal

For controlling an external RGB or YUV switch a select signal is supplied. The delay of this signal is programmable for adaptation to different external output signal processing devices (**SELDEL**).

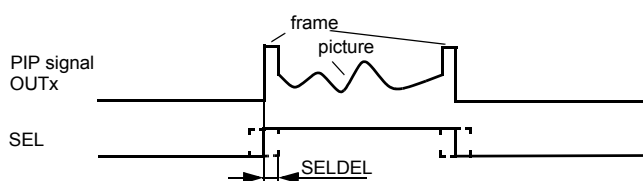

Fig. 2–17: Select Timing

2.8.7. Automatic Brightness Reduction

Displaying a bright PIP picture, the beam current limitation of the parent system may become active. This may cause the parent picture to be influenced by the inset picture. Therefore a detection circuit reduces the brightness of the inset picture when the average brightness is above a selectable threshold. After bright picture content has disappeared, the initial brightness reappears. The threshold is adjustable via **ABRTHD** and the speed via **ABRSPD**. Both settings have to be selected for parent system accordingly.

2.9. On Screen Display (OSD)

2.9.1. Display Format

The on screen display allows to insert a block of 5 characters into each of the PIP pictures. The characters are placed in a box (background) whose width is 64 pixels and height is 12 lines. This box is placed in the upper left corner of the PIP picture. 64 different characters are stored in a character ROM. Each character is defined by a pixel matrix consisting of 10 lines and 12 pixels per line. A doubling of the character's height and width is achieved by **CHRDHW**. The OSD starting position is not influenced.

OSD display is also possible if PIP is switched off (**DISPMOD** = '10010'). Now 3 lines of 20 characters each are displayed at the PIP position.



Fig. 2–18: Example of OSD-only Mode

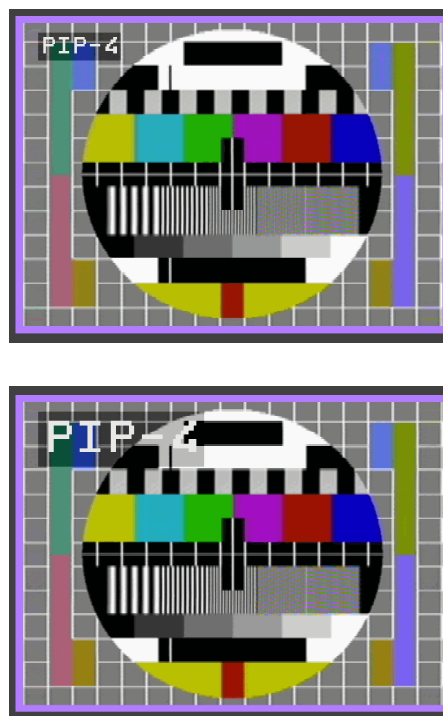

Fig. 2–19: Example of Transparent Mode (Normal and Double Size OSD)

2.9.2. Character Programming

The characters are programmed via I²C bus using a 7 bit code which is identical with the ASCII code except for some of the special characters. The codes are stored in a character RAM consisting of 60 cells. The character codes can be transmitted in two ways: each character position can be addressed separately by its 7 bit address or the characters can be written consecutively starting at an arbitrarily chosen position. In this case the address is increased automatically. The 7 bit address consists of two parts: the 4 MSBs are used to chose one of the partial pictures and the 3 LSBs to select one of the 5 characters per block.

2.9.3. Character and Character Background Color

The character's color is either same as frame color (**CHRFRC**) or the character appears with a grey value programmable with **CHRY**.

The character's background box is influenced by **CHRBGON** and **CHRBGY**. It can be made transparent so that behind the characters the inset picture becomes visible. Alternatively the semi-transparent mode can be chosen. At this mode the background box contains the original picture content with reduced luminance value. This mode offers a good trade-off between reduction of visible display area and character readability.

2.10. DA-Conversion And RGB/YUV Switch

The PVP 9390A includes three 7 bit DA-converters. Brightness **BRTADJ**, Contrast **CONADJ** and overall amplitude **PKLR**, **PKLG**, **PKLB** of the output signal are adjustable. External RGB or YUV signals can be connected to the inputs IN1...3. By forcing the FSW input to high-level these signals are switched to the outputs OUT1...3 while the internal signals are switched off. The switch of YUV signals with sync on Y is possible, if **YSYNCOFS** is set. The FSW input signal is passed through to the SEL output. The setting of **RGBINS** determines wether an RGB insertion is possible and which source, the external picture or the PIP, gets priority. See Fig. 2–20.

The external RGB or YUV signals are each clamped to the reference levels of the DACs to force uniform black levels in each channel. The clamping needs careful adjustment especially for VGA applications. The position and the length of the blanking pulse as well as the clamping pulse are adjustable (**CLPPOS**, **CLPLEN**). If **READD** is set to '1' (100 Hz mode), all pulses are shortened by one half. **HZOOM** influences the adjustment range of the clamping and blanking pulse because of the modified clock frequency, but the pulse length is kept nearly constant.

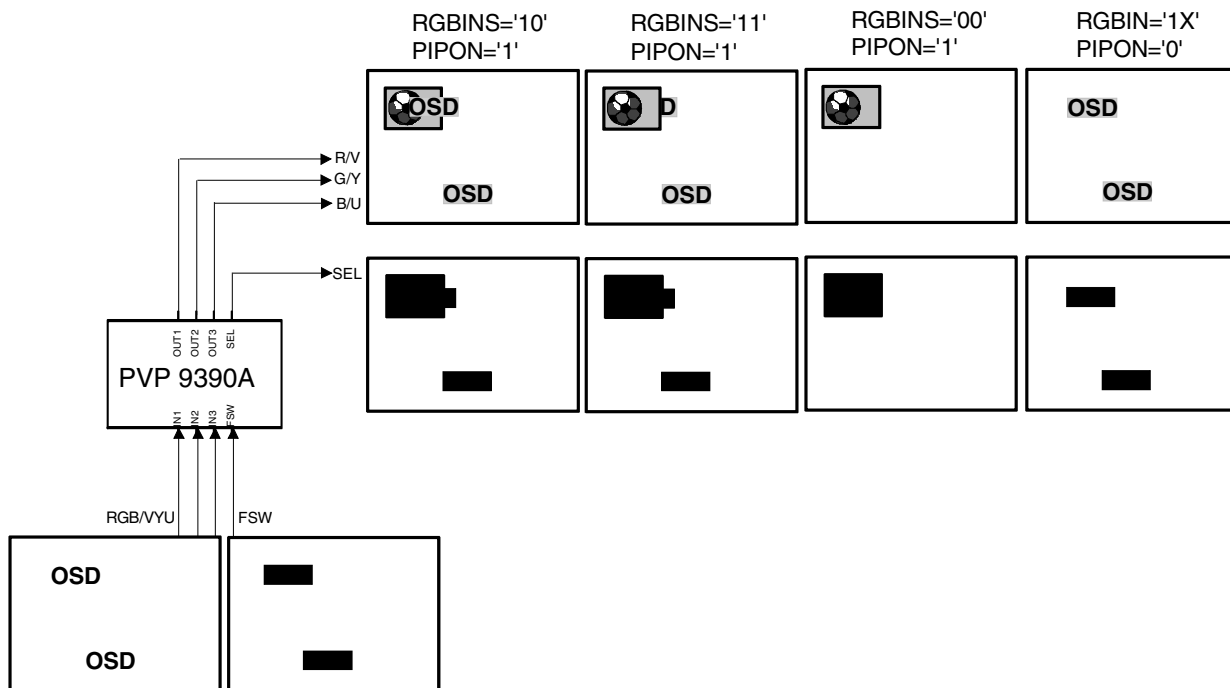

Fig. 2–20: Visualization of RGB/YUV Insertion

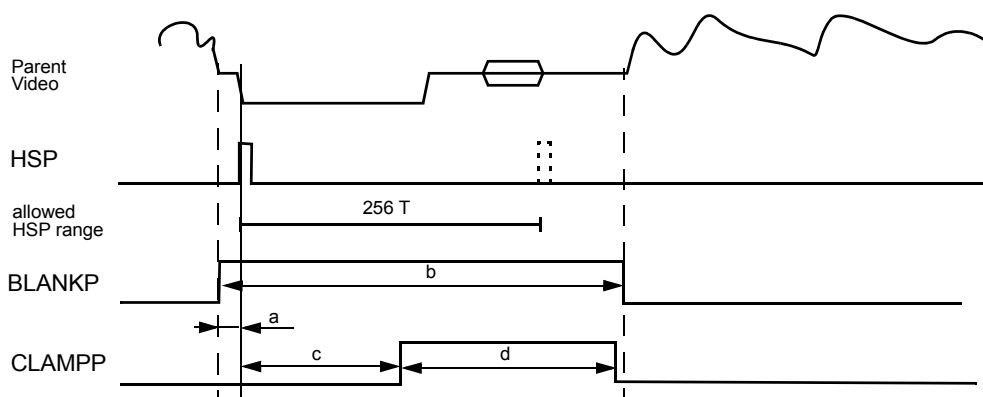

Fig. 2–21: PIP Horizontal Blanking Timing

Table 2–19: PIP horizontal blanking timing examples

READD	CLPDEL			CLPLEN		a (μs)	b (μs)	c (μs)	d (μs)
	D2	D1	D0	D1	D0	Blanking Start	Blanking Duration	Clamping Start	Clamping Duration
0	0	0	0	0	0	-1.5	10.5	3	5
0	1	1	1	0	0	-11	10.5	-6.4	5
0	0	0	0	0	1	-1.5	7.9	2.2	3.8
0	1	1	1	0	1	-11.0	7.9	-7.3	3.8
1	0	0	0	0	0	-0.8	5.3	1.5	2.5
1	1	1	1	0	0	-5.5	5.3	-3.2	2.5
1	0	0	0	0	1	-0.8	4	1.1	1.9
1	1	1	1	0	1	-5.5	4	-3.6	1.9

2.10.1. Pedestal Level Adjustment

The pedestal level adjustment controlled by I²C signals **BLKLR**, **BLKLG**, **BLKLB** enables the correction of small offset errors, possibly appearing at the successive blanking stage of RGB processor. This adjustment has an effect on the setup level during the active line interval of each channel like the brightness adjustment but has an enhanced resolution of 0.5 LSB. The maximum possible offset amounts to 7.5 LSBs. In YUV mode (**OUTFOR** = '1') the action depends on the setting of **BLKINVR** and **BLKINVB**. If **BLKINVR** (**BLKINVB**) is active the offset applies to the blank level of the **RV** (**BU**) channel during the clamping interval for shifting the setup level to the negative direction. In RGB mode (**OUTFOR** = '0') **BLKINVR** and **BLKINVB** have no effect.

2.10.2. Contrast, Brightness and Peak Level Adjustment

The peak level adjustment modifies the magnitude of each channel separately. It should be used to adapt once the signal levels to the following stage. The contrast adjustment influences all three channels and allows a further increase of 30 % of the peak level magnitude. The effect of the brightness adjustment depends on the selected output mode (RGB/YUV). In YUV mode it changes the offset of the OUT2 (Y) signal only while in RGB mode it changes the offset of all three channels at the same time. The brightness increase is up to 20 %.

OUTFOR = '1' (YUV Mode)

BLKINVR = BLKINVB = '0'

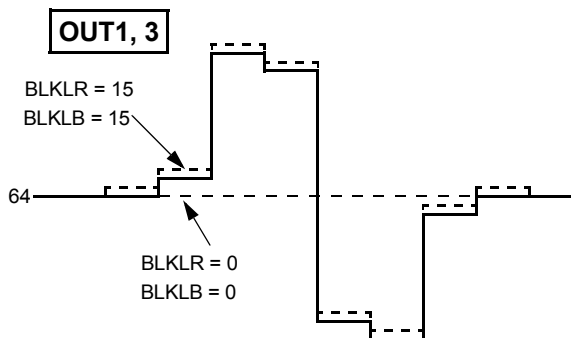

BLKINVR = BLKINVB = '1'

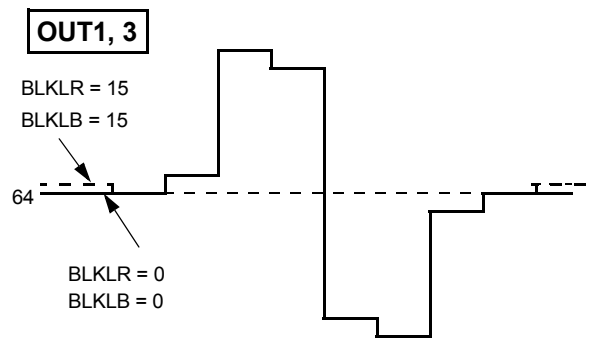

OUTFOR = '0' (RGB Mode)

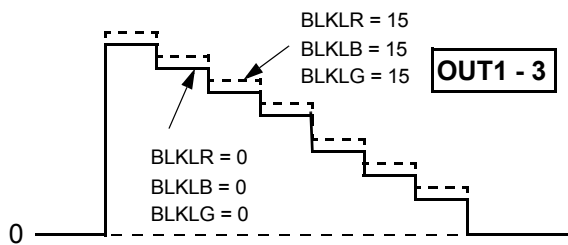

Fig. 2-22: Pedestal Level Adjustment

2.11. Data Slicer

Depending on **SERVICE**, Closed Caption data (“Line 21”) or WSS (Wide-screen signalling) is sliced by the digital data slicer and can be read out from I²C interface. The line number of the sliced data is selectable with **SELLNR**. Therefore WSS and CC can be processed in different regions (e.g. CC with PAL M). The Closed Caption data is assumed to conform with the ITU standards EIA-608 and EIA-744-A. WSS data is assumed to conform with ETS 300 294 (2nd edition, May 1996).

2.11.1. Closed Caption

The closed caption data stream contains different data services. In field 1 (line 21) the captions CC1 and CC2 and the text pages T1 and T2 are transmitted whereas in field 2 (line 284) caption CC3, CC4, text T3, T4 and the XDS data are transmitted. For more information please refer to the above mentioned standards.

Raw CC as well as pre-filtered data is provided alternatively. With the built-in programmable XDS-Filter (**XDSCLS**), the program rating information (“V-chip”) as well as others can be filtered out. The XDS filter reduce traffic on the I²C bus and save calculation power of the main controller. If no class filter is selected, all incoming data (both fields) is sliced and provided by the I²C interface. When one or more class filters are chosen, only data in field 2 is sliced. Any combination of class filters is allowed. Each “CLASS” is divided into “TYPES” which can be sorted out by the XDS-secondary filter (**XDSTPE**). Any combination of type filter is allowed. Some type filter require an appropriate class filter.

```
while (1){
  i2c_read pip_adr, status_reg_adr, status
  if (status & data_valid_mask) {
    i2c_read_inc pip_adr, dataa_reg_adr, dataa, datab, status
    process_data dataa, datab, status
  }
}
```

Fig. 2–23: Example in Pseudo-code for Reading the Data

2.11.2. Wide-screen Signalling (WSS)

In WSS mode (**SERVICE**='1') no filtering is possible. All sliced data is passed to the output registers. In this case **XDSTPE** selects the field number of the data to be sliced. In Europe WSS carries for instance information about aspect ratio and movie mode.

2.11.3. Indication of New Data

The sliced and possibly filtered data is available in **DATAA** and **DATAB**. The corresponding status bits are **DATAV** and **SLFIELD**. When new data were received, **DATAV** becomes ‘1’ and the controller must read **DATAA**, **DATAB** and the status information. After both data bytes were read **DATAV** becomes ‘0’ until new data arrives. It must be ensured that the data polling is activated once per field (16.7 or 20 ms) or every second field (33.3 or 40 ms), depending on the slicer configuration and inset field frequency. The field number of the data in **DATAA** and **DATAB** can be found in **SLFIELD**. If one or more XDS-class filter are activated, **SLFIELD** contains always ‘1’.

Additionally pin 10 (INT) may flag that new data is received. Default this pin is in tri-state mode to be compatible with the Micronas SDA 9388X/9389X PIP devices. It can also be configured by **IRQCON** to output a single short pulse when new data is available or behave equal to **DATAV**. In the last case the output remains active until the two data registers **DATAA/DATAB** are read. Both modes are useful to avoid continuous polling of the I²C bus. The microcontroller initiates I²C transfers only when required.

2.11.4. Violence Protection

The rating information is sent in the program rating packet of the current (sometimes future) class in the XDS data stream. If only this information is desired the corresponding XDS filter (class 01h, type 05h) should be used to suppress other data. The class/packet bytes (0105h) precede the 2 Bytes rating information. Each sequence is closed by the end-of-packet Byte (0fh) and a checksum. This checksum complements the Byte truncated sum of all Bytes to 00h. Except comparison of the received rating with the adjusted

user rating threshold the microcontroller should check the parity of each Byte and validate the checksum to avoid misinterpretation of wrong received data.

The PVP 9390A offer some alternatives to blocking the PIP channel completely by switching it off (see Fig. 2–24).

The Mosaic mode (**MOSAIC**) hides details of the picture by reduced sharpness and increased aliasing. The picture looks scrambled and is less perceptible.

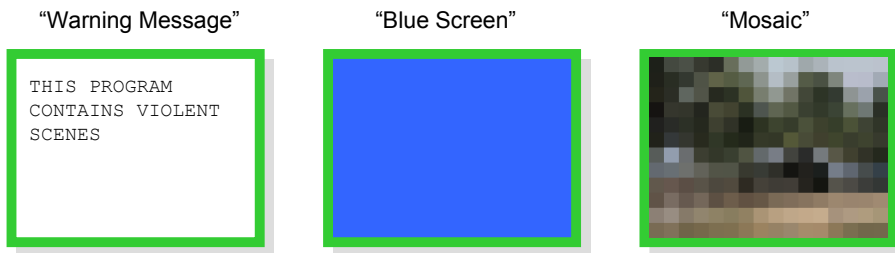

Fig. 2–24: Possibilities of PIP Blocking

2.12. Diagrams

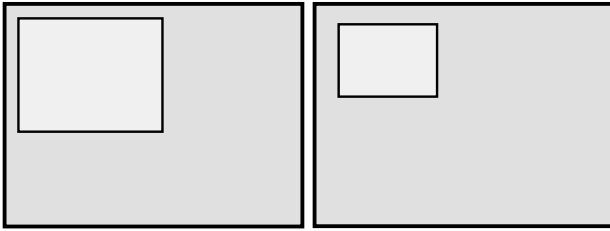

Fig. 2-25: Display Mode 0 with Picture Sizes 1/4 and 1/9

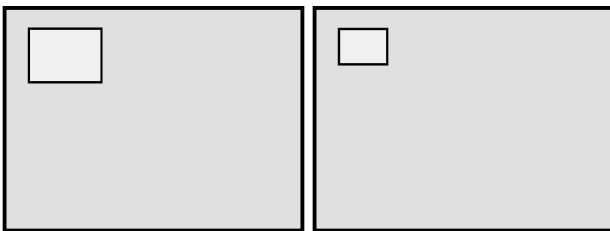

Fig. 2-26: Display Mode 0 with Picture Sizes 1/16 and 1/36

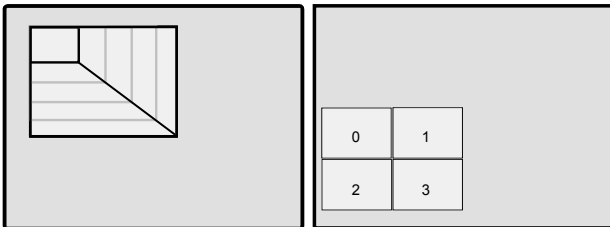

Fig. 2-27: Display Mode 0 (with scaling) and Display Mode 11

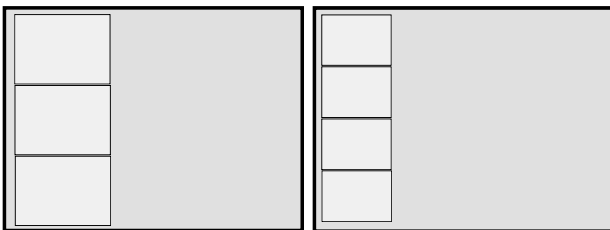

Fig. 2-28: Display Mode 2 and 3 (All Pictures with Same Content)

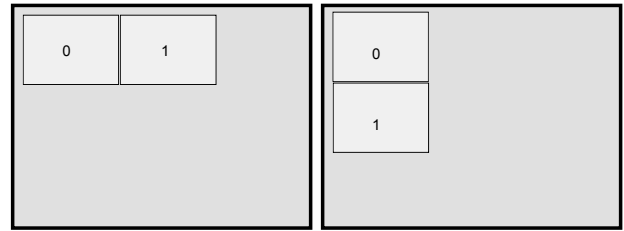

Fig. 2-29: Display Modes 4 and 5

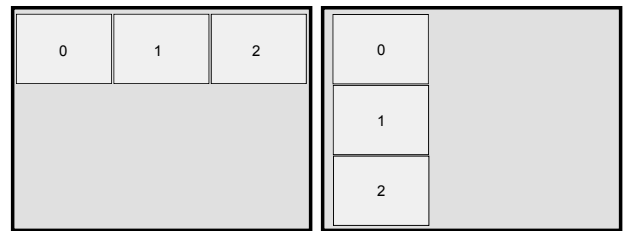

Fig. 2-30: Display Modes 6 and 7

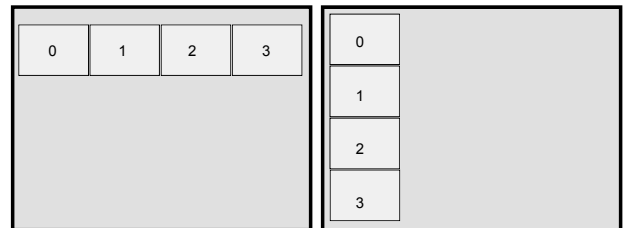

Fig. 2-31: Display Modes 8 and 12

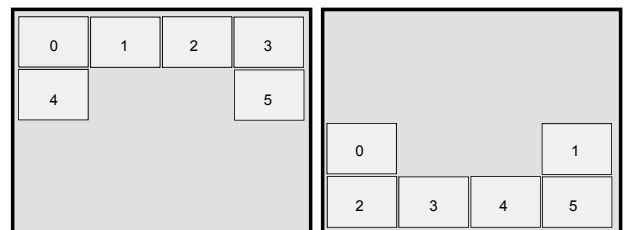

Fig. 2-32: Display Modes 9 and 10

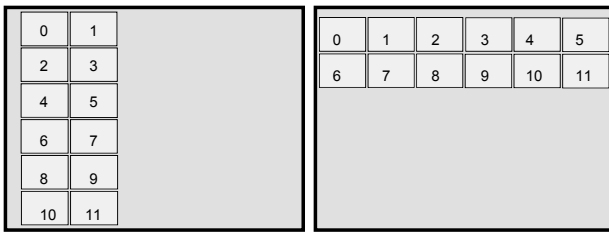

Fig. 2-33: Display Modes 13 and 14

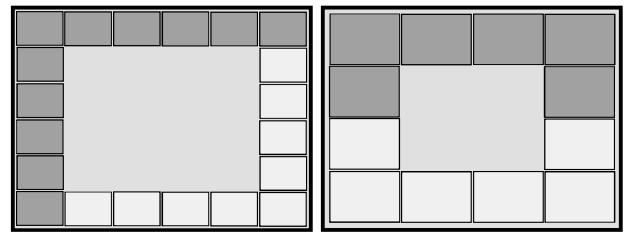

Fig. 2-37: Combination of Display Modes 17/18 and 9/10 (Dual PIP Application)

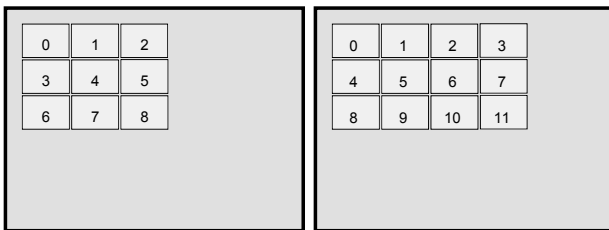

Fig. 2-34: Display Modes 15 and 16

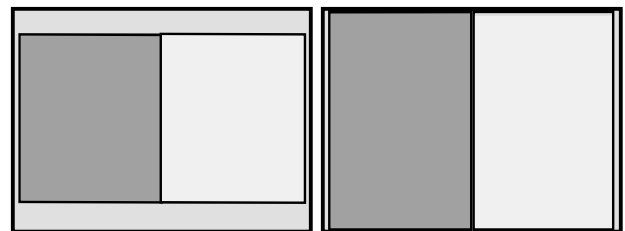

Fig. 2-38: Display Modes 19 and 20 (Dual PIP Application)

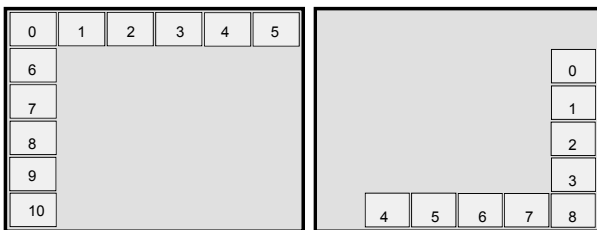

Fig. 2-35: Display Modes 17 and 18

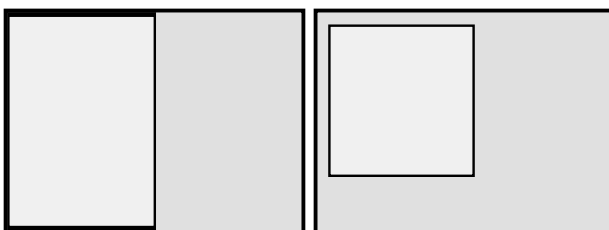

Fig. 2-36: Display Mode 20 (Double Window 1) and 19 (Double Window 1.5)

2.13. OSD Character Set

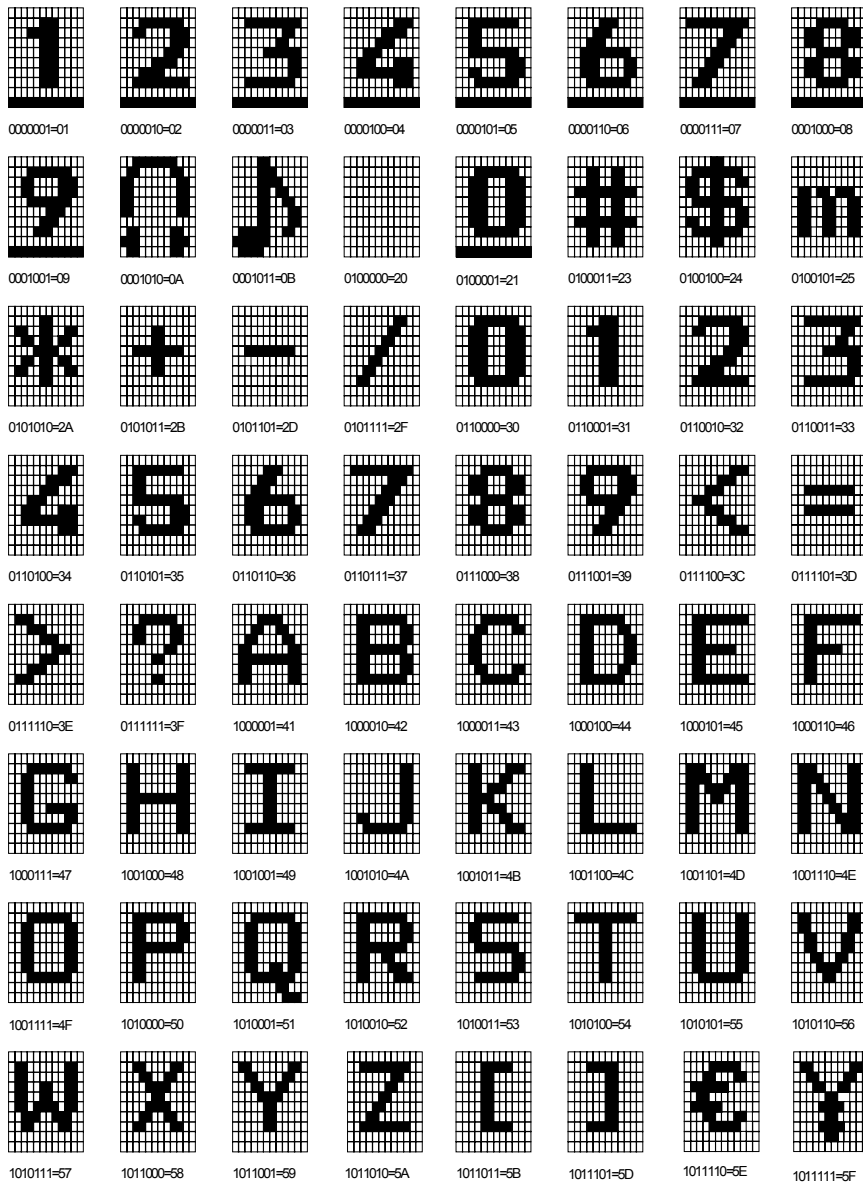

Fig. 2-39: OSD Character Set

3. I²C Bus

3.1. I²C Bus Address

Table 3–1: First address (I2C1= '0', I2C2= '0')

Write Address1	1	1	0	1	0	1	1	0	(D6h)
Read Address1	1	1	0	1	0	1	1	1	(D7h)

Table 3–3: Second address (I2C1= '1', I2C2= '0')

Write Address2	1	1	0	1	1	1	1	0	(DEh)
Read Address2	1	1	0	1	1	1	1	1	(DFh)

Table 3–2: Third address (I2C1= '0', I2C2= '1')

Write Address1	1	1	0	1	0	1	0	0	(D4h)
Read Address1	1	1	0	1	0	1	0	1	(D5h)

Table 3–4: Fourth address (I2C1= '1', I2C1= '1')

Write Address1	1	1	0	1	1	1	0	0	(DCh)
Read Address1	1	1	0	1	1	1	0	1	(DDh)

3.2. I²C Bus Format

Table 3–5: I²C-bus format

WRITE	S	1101x110	A	Subaddress	A	Data Byte		A	****	A	P
READ	S	1101x110	A	Subaddress	A	Sr	1101x111	A	Data Byte n	NA	P
S: Start condition / Sr Repeated start condition / A: Acknowledge / P: Stop condition / NA: No Acknowledge											

Write operation is possible at registers 00h-21h and 2Eh-3Eh only, read operation is possible at registers 28h, 2Ah-2Ch, 3Fh only. An automatic address increment function is implemented.

3.3. I²C Bus Command Table

Table 3–6: I²C bus command table

Subadd (Hex)	Data Byte							
	D7	D6	D5	D4	D3	D2	D1	D0
00h	PIPON	CPOS1	CPOS0	YUVSEL	READD	PROGEN	FIESEL1	FIESEL0
01h	POSHOR7	POSHOR6	POSHOR5	POSHOR4	POSHOR3	POSHOR2	POSHOR1	POSHOR0
02h	POSVOR7	POSVOR6	POSVOR5	POSVOR4	POSVOR3	POSVOR2	POSVOR1	POSVOR0
03h	VFP3	VFP2	VFP1	VFP0	HFP3	HFP2	HFP1	HFP0
04h	DISPSTD1	DISPSTD0	FREEZE	MOSAIC	SIZEHOR1	SIZEHOR0	SIZEVER1	SIZEVER0
05h	FPSTD1	FPSTD0	PIPBG1	PIPBG0	FMACTP	HZOOM2	HZOOM1	HZOOM0
06h	HSPINV	VSPINV	VSPNSRQ	VSPDEL4	VSPDEL3	VSPDEL2	VSPDEL1	VSPDEL0
07h	FRSEL	INFRM	VPSRED	FRWIDH2	FRWIDH1	FRWIDH0	FRWIDV1	FRWIDV0
08h	RGBINS1	RGBINS0	VERBLK	SELDOWN	SELDEL3	SELDEL2	SELDEL1	SELDEL0
09h	Set to 0	DISPMOD1	DISPMOD0	CLPDEL4	CLPDEL3	CLPDEL2	CLPDEL1	CLPDEL0
0Ah	AGCRES	AGCMD1	AGCMD0	AGCVAL3	AGCVAL2	AGCVAL1	AGCVAL0	NOSIGB
0Bh	CVBSEL1	CVBSEL0	CLMPID1	CLMPID0	BLKVCHYS	BLKVCVAL	LMOFST1	LMOFST0
0Ch	PLLITC1	PLLITC0	BLKVCFIL	(reserved)	YCDEL3	YCDEL2	YCDEL1	YCDEL0
0Dh	CSTAND2	CSTAND1	CSTAND0	CSTDEX1	CSTDEX0	(reserved)	CKILL1	CKILL0
0Eh	BGPOS	(reserved)	DEEMP1	DEEMP0	COLON	ACCFIX	CHRBW1	CHRBW0
0Fh	IFCOMP1	IFCOMP0	HUE5	HUE4	HUE3	HUE2	HUE1	HUE0
10h	SATNR	FMACTI	CPLLOF	SCADJ4	SCADJ3	SCADJ2	SCADJ1	SCADJ0
11h	CONADJ3	CONADJ2	CONADJ1	CONADJ0	BLKLR3	BLKLR2	BLKLR1	BLKLR0
12h	BRTADJ3	BRTADJ2	BRTADJ1	BRTADJ0	BLKLG3	BLKLG2	BLKLG1	BLKLG0
13h	TRIOUT	REFINT	BLKINVR	BLKINVB	BLKLB3	BLKLB2	BLKLB1	BLKLB0
14h	PKLR7	PKLR6	PKLR5	PKLR4	PKLR3	PKLR2	PKLR1	PKLR0
15h	PKLG7	PKLG6	PKLG5	PKLG4	PKLG3	PKLG2	PKLG1	PKLG0
16h	PKLB7	PKLB6	PKLB5	PKLB4	PKLB3	PKLB2	PKLB1	PKLB0
17h	MAT1	MAT0	BGY1	BGY0	FRY3	FRY2	FRY1	FRY0
18h	OUTFOR	UVPOLAR	BGU1	BGU0	FRU3	FRU2	FRU1	FRU0
19h	(reserved)	BGFRC	BGV1	BGV0	FRV3	FRV2	FRV1	FRV0
1Ah	SATADJ3	SATADJ2	SATADJ1	SATADJ0	YPEAK2	YPEAK1	YPEAK0	YCOR
1Bh	XDSCLS4	XDSCLS3	XDSCLS2	XDSCLS1	XDSCLS0	XDSTPE2	XDSTPE1	XDSTPE0
1Ch	UVSEQ	MPIPBG	SERVICE	SELLNR1	SELLNR0	IRQCON2	IRQCON1	IRQCON0
1Dh	(reserved)	(reserved)	PALIDL2	PALIDL1_1	PALIDL1_0	PIPBLK	(reserved)	PALIDL0
1Eh	POSOFV2	POSOFV1	POSOFV0	POSOFH4	POSOFH3	POSOFH2	POSOFH1	POSOFH0
1Fh	(reserved)	(reserved)	(reserved)	VSHRNK4	VSHRNK3	VSHRNK2	VSHRNK1	VSHRNK0

Table 3–6: I²C bus command table, continued

Subadd (Hex)	Data Byte							
	D7	D6	D5	D4	D3	D2	D1	D0
20h	(reserved)	(reserved)	(reserved)	HSHRNK4	HSHRNK3	HSHRNK2	HSHRNK1	HSHRNK0
21h	(reserved)	(reserved)	(reserved)	(reserved)	DWCOR	PKBOOST	CLPLEN1	CLPLEN0
22h	PIPHLT	ABRTHD3	ABRTHD2	ABRTHD1	ABRTHD0	ABRSPD2	ABRSPD1	ABRSPD0
23h	INFRMOD	DISPMOD6	DISPMOD5	DISPMOD4	DISPMOD3	DISPMOD2	WIPESP1	WIPESP0
24h	CZMEN	CZMSP1	CZMSP0	(reserved)	WRPOS3	WRPOS2	WRPOS1	WRPOS0
25h	CHRFRC	CHRDHW	CHRY1	CHRY0	CHRBGY1	CHRBGY0	CHRBGON1	CHRBGON0
26h	OSDON	CHRADR6	CHRADR5	CHRADR4	CHRADR3	CHRADR2	CHRADR1	CHRADR0
27h	CHRCLR	CHRCOD6	CHRCOD5	CHRCOD4	CHRCOD3	CHRCOD2	CHRCOD1	CHRCOD0
28h	FRMMD	PIPSTAT	SYSNCST1	SYSNCST0	CKSTAT	STDET2	STDET1	STDET0
29h	(reserved)	(reserved)	(reserved)	(reserved)	(reserved)	(reserved)	(reserved)	(reserved)
2Ah	DATAA7	DATAA6	DATAA5	DATAA4	DATAA3	DATAA2	DATAA1	DATAA0
2Bh	DATAB7	DATAB6	DATAB5	DATAB4	DATAB3	DATAB2	DATAB1	DATAB0
2Ch	PALDET	(reserved)	DEVICE1	DEVICE0	PRNSTD	PALID	DATAV	SLFIELD
2Dh	(reserved)	(reserved)	(reserved)	(reserved)	(reserved)	(reserved)	(reserved)	(reserved)
2Eh	SCMREL1	SCMREL0	SCMIDL2	SCMIDL1	SCMIDL0	SCCDIV	(reserved)	BELLIIR
2Fh	PALINC1	PALINC2	LOCKSP1	LOCKSP0	SECACCL2	SECACCL1	SECACCL0	SECACC
30h	ADLCK	ADLCKSEL	ADLCKCC	CLRANGE1	CLRANGE0	NADJ2	NADJ1	NADJ0
31h	NSRED2	NSRED1	NSRED0	SLLTHD1	SLLTHD0	ISHFT1	ISHFT0	ENLIM
32h	DETECT5060	VTHRL50_6	VTHRL50_5	VTHRL50_4	VTHRL50_3	VTHRL50_2	VTHRL50_1	VTHRL50_0
33h	BCOROFF	VTHRL60_6	VTHRL60_5	VTHRL60_4	VTHRL60_3	VTHRL60_2	VTHRL60_1	VTHRL60_0
34h	VTHRH50_3	VTHRH50_2	VTHRH50_1	VTHRH50_0	VTHRH60_3	VTHRH60_2	VTHRH60_1	VTHRH60_0
35h	CLMPSTGY	SLLTHDVP	SLLTHDV2	SLLTHDV1	SLLTHDV0	VFLYWHLMD1	VFLYWHLMD0	VFLYWHL
36h	FLNSTRD1	FLNSTRD0	CLMPCHARY1	CLMPCHARY0	VDETIFS	VDETITC	VLP1	VLP0
37h	LATENCY1	LATENCY0	FILTBRST	CLMPIST4	CLMPIST3	CLMPIST2	CLMPIST1	CLMPIST0
38h	(reserved)	(reserved)	(reserved)	CLKP_INV	INCRSEL	FINECLMP	INSEL_1	INSEL_0
39h	DTOINCR_7	DTOINCR_6	DTOINCR_5	DTOINCR_4	DTOINCR_3	DTOINCR_2	DTOINCR_1	DTOINCR_0
3Ah	(reserved)	(reserved)	(reserved)	GPO_2	GPO_1	GPO_0	GPOEN	CLKOUTEN
3Bh	(reserved)	(reserved)	(reserved)	(reserved)	(reserved)	(reserved)	(reserved)	YSYNCOFS
3Ch	(reserved)	(reserved)	AFIL_OFF	STBY_REF	STBY_OTA	STBY_ADC1	STBY_ADC2	STBY_ADC3
3Dh	STBY_BUFFER	STBY_CLAMP	STBY_DAC1	STBY_DAC2	STBY_DAC3	STBY_GAIN	STBY_OFFSET	STBY_REF
3Eh	TRIM_BGP_7	TRIM_BGP_6	TRIM_BGP_5	TRIM_BGP_4	TRIM_BGP_3	TRIM_BGP_2	TRIM_BGP_1	TRIM_BGP_0
3Fh	(reserved)	(reserved)	(reserved)	(reserved)	(reserved)	(reserved)	PVPREV_1	PVPREV_0

Grey shading = After power on, the grey marked data bits are set to '1', all other to '0'

3.4. I²C Bus Command Description

Subaddress 00h

Table 3–7: PIPON

PIPON	PIP On:
D7	Switches the PIP insertion on
0	PIP insertion off
1	PIP insertion on

Table 3–8: CPOS

CPOS		Coarse Position:
D6	D5	Coarse position of the picture
0	0	Upper left position
0	1	Upper right position
1	0	Lower left position
1	1	Lower right position

Table 3–9: YUVSEL

YUVSEL	YUV Select:
D4	Selects YUV mode
0	CVBS or Y/C source
1	YUV source

Table 3–10: READD

READD	Read Double Mode:
D3	Double read frequency for compatibility with systems that use 2fH (e.g. 100 Hz, progressive)
0	PIP display with single read frequency and 2x oversampling
1	PIP display with double read frequency

Table 3–11: PROGEN

PROGEN	Progressive Scan Enable: For compatibility with progressive scan systems
D2	
0	Each line of PIP is read once (normal operation)
1	Each line of PIP is read twice (line doubling operation)

Table 3–12: FIESEL

FIESEL		Field Select: Set field or frame display mode
D1	D0	
0	0	Frame mode (if possible)
0	1	Field mode (first field only)
1	0	Field mode (second field only)
1	1	Field mode (one of both)

Subaddress 01h

Table 3–13: POSHOR

POSHOR	Horizontal Picture Position: Horizontal position adjustment of the PIP in steps of 4 pixel shift direction depends on the coarse positioning of the picture
D7-D0	

Subaddress 02h

Table 3–14: POSVER

POSVER	Vertical Picture Position: Vertical position adjustment of the PIP in steps of 1 lines shift direction depends on the coarse positioning of the picture
D7-D0	

Subaddress 03h**Table 3–15: HFP**

HFP				Horizontal Fine Positioning: Changes the position of the horizontal acquisition window by steps of 2 pixel	Note
D3	D2	D1	D0		
1	0	0	0	-16 pixel (-0.8 μ s), most right position of the image	Values refer to the undecimated picture
...					
0	0	0	0	0 pixel, nominal center position	
...					
0	1	1	1	+14 pixel (0.7 μ s), most left position	

Table 3–16: VFP

VFP				Vertical Fine Positioning: Changes the position of the vertical acquisition window by steps of 1 line	Note
D7	D6	D5	D4		
1	0	0	0	-8 lines, most upper position of the image	Values refer to the undecimated picture
...					
0	0	0	0	0 lines, nominal center position	
...					
0	1	1	1	+7 lines, most lower position	

Subaddress 04h**Table 3–17: DISPSTD**

DISPSTD		Display Standard: Selects the line standard of PIP display
D7	D6	
0	0	PIP depends on detected parent standard (multi PIP) or inset standard (single PIP)
0	1	PIP display is always in 625 line mode
1	0	PIP display is always in 525 line mode
1	1	Freeze last detected display standard and size

Table 3–18: FREEZE

FREEZE	Freeze Picture:
D5	Interrupts the inset picture writing and displays still picture
0	Live picture
1	Still picture

Table 3–19: MOSAIC

MOSAIC	Mosaic Mode:
D4	Hides picture details, intended for use with parental control
0	Mosaic mode off
1	Mosaic mode on

Table 3–20: SIZEHOR

SIZEHOR		Horizontal Size:
D3	D2	Horizontal decimation
0	0	Reduction = 2
0	1	Reduction = 3
1	0	Reduction = 4
1	1	Reduction = 6

Table 3–21: SIZEVER

SIZEVER		Vertical Size:
D1	D0	Vertical decimation
0	0	Reduction = 2
0	1	Reduction = 3
1	0	Reduction = 4
1	1	Reduction = 6

Subaddress 05h

Table 3–22: FPSTD

FPSTD		Force Parent Standard: Forces the parent standard to one of the following modes
D7	D6	
0	0	Auto-detect parent standard
0	1	50 Hz/625 lines parent standard forced
1	0	60 Hz/525 lines parent standard forced
1	1	Freeze last detected standard

Table 3–23: PIPBG

PIPBG		PIP Background Display: Selects the background display
D5	D4	
0	0	PIP visible, no background display
0	1	PIP invisible, background display in PIP
1	0	PIP visible, full screen background display
1	1	PIP invisible, background display in PIP and full screen background

Table 3–24: FMACTP

FMACTP	Frame Mode Activation Parent: Selects the parent condition for the activation of the frame mode
D3	
0	Frame mode active for standard parent video sources only
1	Frame mode active for some nonstandard sources also

Table 3–25: HZOOM

HZOOM			Horizontal Zoom: Selects the parent (display) clock frequency
D2	D1	D0	
0	0	0	27.34 MHz
0	0	1	20.25 MHz
0	1	0	35.27 MHz

Table 3–25: HZOOM, continued

HZOOM			Horizontal Zoom: Selects the parent (display) clock frequency
D2	D1	D0	
0	1	1	25.43 MHz
1	0	0	26.67 MHz
1	0	1	20.63 MHz
1	1	0	34.17 MHz
1	1	1	28.04 MHz

Subaddress 06h**Table 3–26:** HSPINV

HSPINV	Horizontal Sync Pulse Inversion: Inverts the polarity of HSP
D7	
0	No inversion, raising edge is sync reference
1	HSP inverted, falling edge is sync reference

Table 3–27: VSPINV

VSPINV	Vertical Sync Pulse Inversion: Inverts the polarity of VSP
D6	
0	No inversion, raising edge is sync reference
1	VSP inverted, falling edge is sync reference

Table 3–28: VSPNSRQ

VSPNSRQ	Vertical Sync Pulse Noise Reduction: Activates automatic V insertion that generates vertical sync pulses in case of missing external VSP
D5	
0	On
1	Off

Table 3–29: VSPDEL

VSPDEL					Vertical Sync Pulse Delay: Delay of the vertical sync pulse in steps of 128 parent clocks	Note
D4	D3	D2	D1	D0		
0	0	0	0	0	No delay (0)	Delay depends on HZOOM
...						
1	1	1	1	1	Maximum delay, 4096 clocks of parent frequency	

Subaddress 07h**Table 3–30: FRSEL**

FRSEL	Frame Select: Selects between the normal frame and the shaded frame
D7	
0	Normal frame
1	Shaded frame with 3D impression

Table 3–31: INFRM

INFRM	Inner Frame Activation: Activates inner frame (4 pixel width, 2 lines height) for multi-PIP display)
D6	
0	Inner frame off
1	Inner frame on

Table 3–32: VPSRED

VPSRED	Vertical Picture Size Reduction: Reduces vertical picture size to suppress black bars in 16:9 programs
D5	
0	No reduction
1	Reduction on

Table 3–33: FRWIDH

FRWIDH			Frame Width Horizontal: Adjusts the horizontal width of the PIP frame in steps of one pixel
D4	D3	D2	
0	0	0	No horizontal frame
...			
1	1	1	7 pixel

Table 3–34: FRWIDV

FRWIDV		Frame Width Vertical: Adjusts the vertical width of the PIP frame in steps of one line
D1	D0	
0	0	No vertical frame
...		
1	1	3 lines

Subaddress 08h**Table 3–35: RGBINS**

RGBINS		RGB Insertion: Controls the insertion of external RGB/YUV sources
D7	D6	
0	0	No external insertion possible, FSW input inactive
0	1	External insertion forced (FSW = 1)
1	0	External insertion with FSW possible (priority of FSW input)
1	1	External insertion with FSW possible (priority of PIP)

Table 3–36: VERBLK

VERBLK	Vertical Blanking: Switches the vertical blanking mode
D5	
0	Blanking level at DAC outputs only during line-blanking intervals
1	Blanking level at DAC outputs during line-blanking intervals and field-blanking intervals, 16 lines following the parent vertical synchronization pulse are blanked

Table 3–37: SELDOWN

SELDOWN		Select Down: Switches the driver type at the output of the SEL pin
D4		
0		Open source output
1		TTL output

Table 3–38: SELDEL

SELDEL				Select Delay: Adjusts the delay of select signal
D3	D2	D1	D0	
1	0	0	0	-8 clock periods of display clock
...				
0	0	0	0	0 clock periods of display clock
...				
0	1	1	1	+7 clock cycles of display clock

Subaddress 09h**Table 3–39: DISPMOD**

DISPMOD		Display Mode: Selects display modes with equal pictures
D6	D5	
0	0	Single PIP mode
0	1	3 x1/9 PIP (same content)
1	0	4 x1/16 PIP (same content)
1	1	(Reserved)

Table 3–40: CLPDEL

CLPDEL					Clamping Delay: Delay of the clamping pulse for the external RGB/YUV inputs in steps of 8 parent clock periods
D4	D3	D2	D1	D0	
0	0	0	0	0	No delay (0)
...					
1	1	1	1	1	Maximum delay, 256 clock periods of parent frequency

Subaddress 0Ah**Table 3–41: AGCRES**

AGCRES	Automatic Gain Control Reset: Resets AGC
D7	
0	Normal operation
1	Reset of AGC

Table 3–42: AGCMD

AGCMD		AGC Mode: Controls the AGC operation
D6	D5	
0	0	Evaluation of sync height and ADC overflow
0	1	Evaluation of sync height only
1	0	Evaluation of ADC overflow only
1	1	AGC fixed (gain depends on AGCVAl)

Table 3–43: AGCVAL

AGCVAL				Automatic Gain Control Value: AGC value for fixed mode (AGCMD='11')
D4	D3	D2	D1	
0	0	0	0	Input voltage 0.5 Vpp
...				
1	0	0	0	Input voltage 1 Vpp
...				
1	1	1	1	Input voltage 1.5 Vpp

Table 3–44: NOSIGB

NOSIGB	No Signal Behavior: Controls behavior if synchronization is not possible (no source applied)
D0	
0	Noisy picture
1	Colored background

Subaddress 0Bh**Table 3–45: CVBSEL**

CVBSEL		CVBS Select: Select CVBS source
D7	D6	
0	0	CVBS1
0	1	CVBS2
1	0	Y/C (Y@CVBS2 / C@CVBS3)
1	1	CVBS3

Table 3–46: CLMPID

CLMPID		Clamping Duration: Adjusts duration of clamping pulse for ADC (inset channel)
D5	D4	
0	0	1.28 μ s
0	1	1.77 μ s
1	0	2.27 μ s
1	1	2.96 μ s

Table 3–47: BLKVCHYS

BLKVCHYS	Blankvalue Hysteresis: Blankvalue generation ... (sync-tip clamping only)
D3	
0	Without hysteresis
1	With hysteresis

Table 3–48: BLKVCVAL

BLKVCVAL	Clamping Correction Offset: (Back-porch clamping only)
D2	
0	0
1	-1

Table 3–49: LMOFST

LMOFST		Luminance Offset: Modifies black to blank level offset
D1	D0	
0	0	No offset
0	1	Offset of 16 LSB
1	0	Offset of -8 LSB
1	1	Offset of -16 LSB

Subaddress 0Ch

Table 3–50: PLLITC

PLLITC		Inset PLL Time Constant: Switches the time constant of the inset PLL
D7	D6	
0	0	VCR1 (very fast)
0	1	VCR2
1	0	TV1
1	1	TV2 (very slow)

Table 3–51: BLKVCFIL

BLKVCFIL	Blankvalue Filtering: (Sync-tip clamping only)
D5	
0	Lowpass filter off
1	Lowpass filter on

Table 3–52: YCDEL

YCDEL				Y/C Delay: Adjusts the delay between luminance and chrominance
D3	D2	D1	D0	
1	0	0	0	–8 pixel (–0.4 μs with respect to undecimated picture)
...				
0	0	0	0	0 pixel
...				
0	1	1	1	+7 pixel (0.35 μs)

Subaddress 0Dh

Table 3–53: C STAND

C STAND			Color Standard: Forces the desired color standard
D7	D6	D5	
0	0	0	Automatic standard identification
0	0	1	NTSC-M
0	1	0	PAL-N (Argentina)
0	1	1	PAL-M
1	0	0	NTSC44
1	0	1	PAL-B/G/H/I/D
1	1	0	SECAM
1	1	1	PAL60

Table 3–54: CSTDEX

CSTDEX		Color Standard Exclusion: Excludes standards from automatic standard identification
D4	D3	
0	0	Ignore PAL-M / PAL-N
0	1	Ignore SECAM, PAL B/G, PAL60, NTSC4.4
1	0	Ignore PAL-M / PAL-N / NTSC-M
1	1	Ignore PAL-M / PAL-N / NTSC4.4 / PAL60

Table 3–55: CKILL

CKILL		Color Killer Threshold: Damping of color carrier to switch color off	Note
D1	D0		
0	0	–30 dB	Only valid if color killer active (COLON='0'), Values are approximative
0	1	–18 dB	
1	0	–24 dB	
1	1	Color always off	

Subaddress 0Eh

Table 3–56: BGPOS

BGPOS	Burst Gate Position: Adjusts position of burst gate (SECAM only)
D7	
0	Normal position
1	0.5 μ s delayed

Table 3–57: DEEMP

DEEMP		Deemphase Selection: Adjusts SECAM deemphase filter
D5	D4	
0	0	Filter1
0	1	ITU recommendation
1	0	Filter2
1	1	Filter3

Table 3–58: COLON

COLON	Color On: Disable color killer
D3	
0	Color killer active
1	Color forced on

Table 3–59: ACCFIX

ACCFIX	Disable Automatic Chroma Control: Disables the automatic chroma control (ACC)
D2	
0	ACC active
1	ACC fixed (ACC set to nominal value)

Table 3–60: CHRWB

CHRWB		Chroma Bandwidth	
D1	D0	PAL	SECAM
0	0	Wide	Small
0	1	Medium	Medium
1	0	Reserved	
1	1	Small	Wide

Subaddress 0Fh

Table 3–61: IFCOMP

IFCOMP		IF-Compensation Filter: Equalizes the IF-stage characteristic
D7	D6	
0	0	No filtering
0	1	Chroma bandpass active
1	0	IF-compensation bandpass (6 dB/octave)
1	1	Reserved

Table 3–62: HUE

HUE						Hue Control: Phase of color subcarrier for NTSC	Note
D5	D4	D3	D2	D1	D0		
1	0	0	0	0	0	-44.8 °	Skin color becomes greenish
...							
0	0	0	0	0	0	0°	
...							
0	1	1	1	1	1	43.4 °	Skin color becomes redish

Subaddress 10h

Table 3–63: SATNR

SATNR	Satellite Noise Reduction: Stabilizes the horizontal PLL for bad satellite signals (“fishes”)
D7	
0	Disabled
1	Enabled

Table 3–64: FMACTI

FMACTI	Frame Mode Activation Inset: Sets the inset condition for the activation of the frame mode
D6	
0	Frame mode only active for standard inset video sources
1	Enhanced frame mode activation range

Table 3–65: CPLLOF

CPLLOF	Chroma PLL Off: Opens loop of chroma PLL (only for test and servicing)
D5	
0	Chroma PLL active
1	Chroma PLL opened (free running oscillator)

Table 3–66: SCADJ

SCADJ					Color Subcarrier Adjustment: Color subcarrier frequency fine adjustment
D4	D3	D2	D1	D0	
0	0	0	0	0	Max. negative deviation (–150 ppm)
...					
0	0	1	1	1	Default (for nominal crystal frequency)
...					
1	1	1	1	1	Max. positive deviation (+310 ppm)

Subaddress 11h

Table 3–67: CONADJ

CONADJ				Contrast Adjustment: Adjusts the contrast of the picture, acts on OUT1-OUT3
D7	D6	D5	D4	
0	0	0	0	Nominal contrast
...				
1	1	1	1	+30 % contrast increase

Table 3–68: BLKLR

BLKLR				Blanking Level Red: Adjusts the pedestal level of the OUT1 channel in steps of 0.5 LSB
D3	D2	D1	D0	
0	0	0	0	No pedestal
...				
1	1	1	1	+7.5 LSB offset

Subaddress 12h

Table 3–69: BRTADJ

BRTADJ				Brightness Adjustment: Adjusts the brightness of the picture, acts on OUT1-OUT3 in RGB mode (YUVFOR = '0') and on OUT1 in YUV mode (YUVFOR = '1')
D7	D6	D5	D4	
0	0	0	0	Nominal brightness
...				
1	1	1	1	+20 % brightness increase

Table 3–70: BLKLG

BLKLG				Blanking Level Green: Adjusts the pedestal level of the OUT2 channel in steps of 0.5 LSB
D3	D2	D1	D0	
0	0	0	0	No pedestal
...				
1	1	1	1	+7.5 LSB offset

Subaddress 13h

Table 3–71: TRIOUT

TRIOUT	Tri-state Output:
D7	Sets OUT1-OUT3 to tristate mode (high resistance)
0	Normal operation, outputs are active
1	Pins OUT1-3 are in tri-state mode

Table 3–72: REFINT

REFINT	Refresh Interval:	Note
D6	Changes the refresh rate of eDRAM	
0	Normal refresh	Keep it at '0'
1	Fast refresh	

Table 3–73: BLKINVR

BLKINVR	Blanking Inversion Red:
D5	Inverts the sign of the OUT1 channel offset (BLKLR)
0	Offset added during the active picture
1	Offset added during blanking

Table 3–74: BLKINVB

BLKINVB	Blanking Inversion Blue:
D4	Inverts the sign of the OUT3 channel offset (BLKLB)
0	Offset added during the active picture
1	Offset added during blanking

Table 3–75: BLKLB

BLKLB				Blanking Level Blue: Adjusts the pedestal level of the OUT3 channel in steps of 0.5 LSB
D3	D2	D1	D0	
0	0	0	0	No pedestal
...				
1	1	1	1	+7.5 LSB offset

Subaddress 14h

Table 3–76: PKLR

PKLR								Peak Level Red: Peak to peak output voltage of the OUT1 channel	Note
D7	D6	D5	D4	D3	D2	D1	D0		
0	0	0	0	0	0	0	0	0.3 V _{pp}	Values refer to contrast (CONADJ) and bright- ness (BRTADJ) at mini- mum
...									
1	1	0	0	0	0	0	0	1 V _{pp}	
...									
1	1	1	1	1	1	1	1	1.2 V _{pp}	

Subaddress 15h

Table 3–77: PKLG

PKLG								Peak Level Green: Peak to peak output voltage of the OUT2 channel	Note
D7	D6	D5	D4	D3	D2	D1	D0		
0	0	0	0	0	0	0	0	0.3 V _{pp}	Values refer to contrast (CONADJ) and brightness (BRTADJ) at minimum
...									
1	1	0	0	0	0	0	0	1 V _{pp}	
...									
1	1	1	1	1	1	1	1	1.2 V _{pp}	

Subaddress 16h

Table 3–78: PKLB

PKLB								Peak Level Blue: Peak to peak output voltage of the OUT2 channel	Note
D7	D6	D5	D4	D3	D2	D1	D0		
0	0	0	0	0	0	0	0	0.3 V _{pp}	Values refer to contrast (CONADJ) and brightness (BRTADJ) at minimum
...									
1	1	0	0	0	0	0	0	1 V _{pp}	
...									
1	1	1	1	1	1	1	1	1.2 V _{pp}	

Subaddress 17h

Table 3–79: MAT

MAT		RGB Matrix Select: Selects the RGB matrix coefficients for YUV to RGB conversion
D7	D6	
0	0	EBU- Matrix
0	1	NTSC-Japan Matrix
1	0	NTSC-USA Matrix
1	1	(Reserved)

Table 3–80: BGY

BGY	Background Color Y: Adjusts the Y background color component the values gives the two MSBs of the Y background signal
D5-D4	

Table 3–81: FRY

FRY	Frame Color Y: Adjusts the Y frame color component the value gives the 4 MSBs of the Y frame signal
D3-D0	

Subaddress 18h

Table 3–82: OUTFOR

OUTFOR	Output Format: Switches between RGB output and YUV output
D7	
0	RGB output signals, matrix active
1	YUV output signals

Table 3–83: UVPOLAR

UVPOLAR	UV Polarity: Switches between UV or inverted UV output, has no influence in RGB mode
D6	
0	+U / +V output
1	–U / –V output

Table 3–84: BGU

BGU	Background Color U: Adjusts the U background color component the values gives the two MSBs of the U background signal
D5-D4	

Table 3–85: FRU

FRU	Frame Color U: Adjusts the U frame color component the value gives the 4 MSBs of the U frame signal
D3-D0	

Subaddress 19h**Table 3–86: BGFRC**

BGFRC	Background Frame Color: Selects background color table or frame color table for background color
D6	
0	Background color according to BGY, BGU, BGV
1	Background color according to FRY, FRU, FRV

Table 3–87: BGV

BGV	Background Color V: Adjusts the V background color component the values gives the two MSBs of the V background signal
D5-D4	

Table 3–88: FRV

FRV	Frame Color V: Adjusts the V frame color component the value gives the 4 MSBs of the V frame signal
D3-D0	

Subaddress 1Ah

Table 3–89: SATADJ

SATADJ				Color Saturation Adjustment: Adjusts the color saturation in steps of x/8
D7	D6	D5	D4	
0	0	0	0	No color
...				
1	0	0	0	Nominal saturation
...				
1	1	1	1	1.875 times saturation

Table 3–90: YPEAK

YPEAK			Y Peaking Adjustment: Adjusts luminance peaking
D3	D2	D1	
0	0	0	No peaking
...			
0	1	1	Recommended value
...			
1	1	1	Strongest peaking

Table 3–91: YCOR

YCOR	Y Coring Enable: Suppresses noise introduced by peaking
D0	
0	Coring off
1	1 LSB coring

Subaddress 1Bh

Table 3–92: XDSCLS

XDSCLS					XDS Class Select: Closed Caption XDS-Primary Filter (Class)
D7	D6	D5	D4	D3	
0	0	0	0	0	Transparent, no filtering
1	X	X	X	X	'Current' class selected
X	1	X	X	X	'Future' class selected
X	X	1	X	X	'Channel' class selected
X	X	X	1	X	'Miscellaneous' class selected
X	X	X	X	1	'Public Services' class selected

Table 3–93: XDSTPE

XDSTPE			XDS Type Select/WSS Field Select			
D2	D1	D0	XDS-Secondary Filter Type	Meaning	WSS field	Note
0	0	0	All	No filtering	0	Behavior of these bits depends on selected data-service
0	0	1	05h	Program rating	1	
0	1	0	01h, 04h	Time information only	0/1	
0	1	1	40h	Out of band only	0/1	
1	0	0	01h, 02h, 03h, 04h, 0Dh, 40h	VCR information	0/1	
1	0	1	01h, 04h, 05h	Time information and program rating	0/1	
1	1	0	05h, 40h	Out of band and program rating	0/1	
1	1	1	01h, 02h, 03h, 04h, 05h, 0Dh, 40h	VCR information and program rating	0/1	

Subaddress 1Ch

Table 3–94: UVSEQ

UVSEQ	UV Sequence:	Note
D7	Changes the UV multiplex sequence	
0	U and V are correct	Valid only if YUVSEL= '1'
1	U and V are exchanged	

Table 3–95: MPIPBG

MPIPBG	Multi-PIP Background:
D6	Selects the background color for multi-PIP mode
0	Black
1	Same as background color

Table 3–96: SERVICE

SERVICE	Data Service Select:
D5	Selects data service for slicing
0	Closed Caption
1	Widescreen Signalling (WSS)

Table 3–97: SELLNR

SELLNR		Select Line Number:	Note
D4	D3	Line number of data service field 0 (field1)	
0	0	[NTSC] 20 (283), [PAL M] 17 (280)	WSS
0	1	[NTSC] 21 (284), [PAL M] 18 (281)	Closed Caption
1	0	[PAL B/G] 22 (329)	Closed Caption
1	1	[PAL B/G] 23 (330)	WSS

Table 3–98: IRQCON

IRQCON			Interrupt Request Pin Configuration: Output of INT pin is:	Note
D2	D1	D0		
0	0	0	Tri-state (high-Z)	
0	0	1	Interrupt, when new data received (neg. polarity)	Pulse length is approximately 2 μ s
0	1	0	Interrupt, when new data received (pos. polarity)	
0	1	1	Equivalent to DATAV for both registers (neg. polarity)	
1	0	0	Equivalent to DATAV for both registers (pos. polarity)	
1	0	1	Inset V-pulse (neg. polarity)	Pulse length is 50 ns
1	1	0	Inset field	High = first field, low = second field,
1	1	1	Inset clamping pulse (neg. polarity)	Only for test purpose

Subaddress 1Dh**Table 3–99: PALIDL2**

PALIDL2	PAL/NTSC identifikation level 2 : Sensitivity of identification of PAL/NTSC signals
D5	
0	1/2 or 1/4
1	1/8 or 1/16

Table 3–100: PALIDL1

PALIDL1		PAL/NTSC identifikation level 1: Sensitivity of identification of PAL/NTSC signals
D4	D3	
0	0	+0
0	1	+32
1	0	+64
1	1	+128

Table 3–101: PIPBLK

PIPBLK	PIP Blank:
D2	Blanks the current picture by setting it to background color
0	No blank
1	Blanks the current selected (WRPOS) PIP

Table 3–102: PALIDL

PALIDL	PAL ID Level:
D0	Sensitivity of identification of PAL/NTSC signals
0	High rejection of PAL/NTSC
1	Low rejection of PAL/NTSC

Subaddress 1Eh

Table 3–103: POSOFV

POSOFV			Position Offset Vertical:
D7	D6	D5	Vertical position offset in steps of 4 lines
1	0	0	–16 lines
...			
0	0	0	0 lines
...			
0	1	1	+12 lines

Table 3–104: POSOFH

POSOFH					Position Offset Horizontal: Horizontal position offset in steps of 16 pixel
D4	D3	D2	D1	D0	
1	0	0	0	0	-256 pixel
...					
0	0	0	0	0	0 pixel
...					
0	1	1	1	1	+240 pixel

Subaddress 1Fh

Table 3–105: VSHRNK

VSHRNK					Vertical Shrink: Changes the vertical size in steps of 2 lines	Note
D4	D3	D2	D1	D0		
0	0	0	0	0	No shrink, picture size according to SIZEVER	Max. usable value depends on SIZEVER
...						
1	1	1	1	1	Max. possible shrink	

Subaddress 20h

Table 3–106: HSHRNK

HSHRNK					Horizontal Shrink: Changes the horizontal size in steps of 4 pixel	Note
D4	D3	D2	D1	D0		
0	0	0	0	0	No shrink, picture size according to SIZEHOR	Max. usable value depends on SIZEVER
...						
1	1	1	1	1	Max. possible shrink	

Subaddress 21h

Table 3–107: DWCOR

DWCOR	Test only
D3	
0	(Reserved)
1	Normal operation

Table 3–108: PKBOOST

PKBOOST	Peaking Boost: Influences peaking of <i>YPEAK</i> (A2h)
D2	
0	Use normal peaking values
1	Double peaking values

Table 3–109: CLPLEN

CLPLEN		Clamping Pulse Length		
D1	D0	Clamping Pulse Length	Blanking Duration	Note
0	0	5 μ s	10.5 μ s	The clamping pulse length and the blanking is also influenced by the setting of READD and HZOOM
0	1	3.75 μ s	7.9 μ s	
1	0	2.5 μ s	5.2 μ s	
1	1	1.25 μ s	2.6 μ s	

Subaddress 22h

Table 3–110: PIPHLT

PIPHLT	PIP Highlighting: Highlights the current selected (WRPOS) PIPr
D7	
0	No highlighting
1	Highlighting the PIP

Table 3–111: ABRTHD

ABRTHD				Automatic Brightness Reduction Threshold: Threshold adjustment for reduction of luminance magnitude
D6	D5	D4	D3	
0	0	0	0	ABR off
0	0	0	1	ABR threshold at luminance value of 240
...				
1	1	1	1	ABR threshold at luminance value of 180

Table 3–112: ABRSPD

ABRSPD			Automatic Brightness Reduction Speed: Speed adjustment for reduction of luminance magnitude
D2	D1	D0	
0	0	0	2 fields
...			
1	1	1	16 fields

Subaddress 23h

Table 3–113: INFRMOD

INFRMOD	Inner Frame Modification: Modifies the look of the frame for dual-PIP applications
D7	
0	Inner frame suited for usage of single PIP applications
1	Inner frame suited for usage of dual PIP applications

Table 3–114: DISPMOD

DISPMOD					Display Mode: Selects the single PIP modes, multi-PIP modes or double-window mode	Note
D6	D5	D4	D3	D2		
0	0	0	0	0	Single PIP mode	See Table 2–9 on page 15 for description of modes
...						
1	0	0	1	0	OSD only mode	

Table 3–115: WIPESP

WIPESP		Wipe Speed: Selects the period for opening/closing the PIP window
D1	D0	
0	0	Wipe off
0	1	1/3 second
1	0	2/3 second
1	1	1 second

Subaddress 24h

Table 3–116: CZMEN

CZMEN	Continuos Zoom Enable: Controls the update of the picture size
D7	
0	Delayed execution of HDEC/VDEC/HSRKNK/VSHRKNK update
1	Picture size will be updated

Table 3–117: CZMSP

CZMSP		Continuos Zoom Speed: Speed setting for continous zooming	Note
D6	D5		
0	0	No zoom	1 step means 20 pixel and 8 lines (PAL) or 6 lines (NTSC) decrement or increment
0	1	1 step per 1 fields	
1	0	1 step per 2 fields	
1	1	1 step per 4 fields	

Table 3–118: WRPOS

WRPOS				Write Position: Position of the current written picture	Note
D3	D2	D1	D0		
0	0	0	0	First writing position = first picture	Number of last valid writing position depends on display mode (DISPMOD)
0	0	0	1	Second writing position	
...					
1	0	0	1	Maximum writing position	

Subaddress 25h

Table 3–119: CHRFRFC

CHRFRFC	Character Frame Color: Modifies the character color
D7	
0	Character luminance table used
1	Frame color table used

Table 3–120: CHRDPHW

CHRDPHW	Character Double Height and Width: Doubles the characters' height and width
D6	
0	Normal height and width
1	Double height and width

Table 3–121: CHRY

CHRY		Character Luminance: Character luminance level (IRE)	Note
D5	D4		
0	0	60	Valid only if CHRFRFC = '0', character chrominance is 0 IRE
0	1	70	
1	0	80	
1	1	90	

Table 3–122: CHRBGY

CHRBGY		Character Background Luminance: Character background luminance level (IRE)
D3	D2	
0	0	10
0	1	20
1	0	30
1	1	40

Table 3–123: CHRBGON

CHRBGON		Character Background On: Defines the characters' background	Note
D1	D0		
0	0	No character background (transparent mode)	
0	1	Character background (dependent on CHRBGY)	
1	0	Semi-transparent mode (black&white)	Not possible in case of active background in PIP
1	1	Semi-transparent mode (colored)	

Subaddress 26h

Table 3–124: OSDON

OSDON	OSD On: Switches OSD on
D7	
0	OSD off
1	OSD on

Table 3–125: CHRADR

CHRADR							Character Address			
D6	D5	D4	D3	D2	D1	D0	No. Picture	No. Character	Note	
0	0	0	0	0	0	0	0	0	Will be auto-incremented with every write access to CHR-COD	
0	0	0	0	0	0	1	0	1		
...										
0	0	0	0	1	0	0	0	4		
0	0	0	1	0	0	1	1	1		
...										
1	0	1	1	1	0	0	11	4		

Subaddress 27h

Table 3–126: CHRCLR

CHRCLR	Character Clear:
D7	Resets all characters to 'blank' character
0	No blank
1	Character reset

Table 3–127: CHRCOD

CHRCOD	Character Code:
D6-D0	Character code, see Appendix

Subaddress 28h

Table 3–128: FRMMD

FRMMD	Frame Mode Indication: PIP displays field or frame mode
D7	
0	Field mode, one field is repeated twice
1	Frame mode, both fields are displayed

Table 3–129: PIPSTAT

PIPSTAT	PIP Status: Indication of visibility of PIP, corresponds to PIPON
D6	
0	PIP off
1	PIP on

Table 3–130: SYSNCST

SYNCST		Inset Synchronization Status: Inset synchronization PLL is
D5	D4	
0	0	Not locked to CVBS signal
0	1	
1	0	Locked to CVBS signal (60 Hz)
1	1	Locked to CVBS signal (50 Hz)

Table 3–131: CKSTAT

CKSTAT	Color Killer Status: Chroma is
D3	
0	Off
1	On

Table 3–132: STDET

STDET			Standard Detection: Detected color standard
D2	D1	D0	
0	0	0	Non-standard or standard not detected
0	0	1	NTSC-M
0	1	0	PAL-M
0	1	1	NTSC44
1	0	0	PAL60
1	0	1	PAL-N
1	1	0	SECAM
1	1	1	PAL-B/G

Subaddress 2Ah**Table 3–133: DATAA**

DATAA	First Data Byte: First word of sliced data, D7 = MSB, D0 = LSB
D7-D0	

Subaddress 2Bh**Table 3–134: DATAB**

DATAB	Second Data Byte: Second word of sliced data, D7 = MSB, D0 = LSB
D7-D0	

Subaddress 2Ch

Table 3–135: PALDET

PALDET	PAL identification:
D7	PAL identification (algorithm B)
0	Not PAL
1	PAL

Table 3–136: DEVICE

DEVICE		Device Identification:
D5	D4	Micronas PIP IC
0	0	SDA 9488X (PIP IV Basic)
0	1	SDA 9489X (PIP IV Advanced)
1	0	SDA 9588X (OCTOPUS)
1	1	SDA 9589X (SOPHISTICUS) / PVP 9390A (see Table 3–202 on page 89).

Table 3–137: PRNSTD

PRNSTD	Parent Standard Detection:
D3	Status of parent (display) standard detection
0	60 Hz field frequency detected
1	50 Hz field frequency detected

Table 3–138: PALID

PALID	PAL Identification:	Note
D2	Identification of PAL signal (algorithm A)	
0	NTSC signal	Not valid if STDET= '000'
1	PAL signal	

Table 3–139: DATAV

DATAV	Data Valid: New data indication, used for data flow control (polling mode)
D1	
0	Data read via I ² C or no data available
1	New data received and available in DATAA and DATAB

Table 3–140: SLFIELD

SLFIELD	Sliced Data Field Number: DATAA and DATAB are from
D0	
0	First field
1	Second field

Subaddress 2Eh**Table 3–141: SCMREL**

SCMREL		Secam Rejection Level
D7	D6	
0	0	320
0	1	384
1	0	352
1	1	1024

Table 3–142: SCMIDL

SCMIDL			SECAM Identifikation Level
D5	D4	D3	
0	0	0	128
0	0	1	64
0	1	0	96
0	1	1	80

Table 3–142: SCMIDL, continued

SCMIDL			SECAM Identifikation Level
D5	D4	D3	
1	0	0	70
1	0	1	76
1	1	0	84
1	1	1	90

Table 3–143: SCCDIV

SCCDIV	Secam Divider
D2	
0	Divide by 4
1	Divide by 2

Table 3–144: BELLIIR

BELLIIR	Bellfilter Adjustment
D0	
0	17/64
1	12/64

Subaddress 2Fh

Table 3–145: PALINC1

PALINC1	PAL increment 1: PAL/NTSC identification
D7	
0	+3
1	+2

Table 3–146: PALINC2

PALINC2		PAL increment 2: PAL/NTSC identification
D6		
0		–1
1		–2

Table 3–147: LOCKSP

LOCKSP		Locking Speed: Duration of chroma PLL search
D5	D4	
0	0	25 fields
0	1	20 fields
1	0	17 fields
1	1	15 fields

Table 3–148: SECACCL

SECACCL			Secam Acceptance Level
D3	D2	D1	
0	0	0	100
0	0	1	84
0	1	0	64
0	1	1	32
1	0	0	70
1	0	1	76
1	1	0	90
1	1	1	(Reserved)

Table 3–149: SECACC

SECACC	Secam Acceptance
D0	
0	Disabled
1	Enabled

Subaddress 30h

Table 3–150: ADLCK

ADLCK	Additional Lock-detection
D7	
0	Do not use lock signal
1	Use lock-signal

Table 3–151: ADLCKSEL

ADLCKSEL	Additional Lock-detection Selection
D6	
0	PALID
1	PALDET

Table 3–152: ADLCKCC

ADLCKCC	Additional Lock-detection Color-killer
D5	
0	Do not use lock signal
1	Use lock-signal

Table 3–153: CLRANGE

CLRANGE		Chroma Lock-range
D4	D3	
0	0	± 425 Hz
0	1	± 463 Hz
1	0	± 505 Hz
1	1	± 550 Hz

Table 3–154: NADJ

NADJ			Notch Adjustment: Color-carrier notch adjustment
D2	D1	D0	
0	0	0	Broadest notch
...			
1	1	1	Steepest notch

Subaddress 31h

Table 3–155: NSRED

NSRED			Noise Reduction for Horizontal PLL
D7	D6	D5	
0	0	0	1/16
0	0	1	1/8
0	1	0	1/4
0	1	1	1/2
1	0	0	1
1	0	1	2
1	1	0	4
1	1	1	8

Table 3–156: SLLTHD

SLLTHD		Slicing Level Threshold H
D4	D3	
0	0	No offset
0	1	Adaptive negative (limited to ± 4)
1	0	Adaptive positive (limited to ± 4)
1	1	Adaptive positive (limited to ± 8)

Table 3–157: ISHFT

ISHFT		I-Adjustment for Horizontal PLL
D2	D1	
0	0	*1
0	1	*2
1	0	*4
1	1	*8

Table 3–158: ENLIM

ENLIM	Enable Limiter
D0	
0	Disabled
1	Enabled

Subaddress 32h

Table 3–159: DETECT5060

DETECT5060	Detection of 50 and 60 Hz Signals
D7	
0	Immediately
1	Delayed

Table 3–160: VTHRL50

VTHRL50	Vertical Window Noise Suppression Opening 50 Hz	Note
D6-D0		
0000000	Opening in first line	Opening=4* <i>VTHRL50</i>
...		
1111111	Opening in line 508	

Subaddress 33h

Table 3–161: BCOROFF

BCOROFF	Blanklevel Coring Off: Blanklevel generation coring (for sync-tip clamping only)
D7	
0	Coring on
1	Coring off

Table 3–162: VTHRL60

VTHRL60	Vertical Window Noise Suppression Opening 60 Hz	Note
D6-D0		
0000000	Opening in first line	Opening=4* <i>VTHRL60</i>
...		
1111111	Opening in line 508	

Subaddress 34h

Table 3–163: VTHRH60

VTHRH60	Vertical Window Noise Suppression Closing 60 Hz	Note
D3-D0		
0000	Closing in line 262	Closing=262+4* <i>VTHRH60</i>
...		
1111	Closing in line 262+60	

Table 3–164: VTHR50

VTHR50	Vertical Window Noise Suppression Closing 50 Hz	Note
D7-D4		
0000	Closing in line 312	Closing=312+4* VTHR50
	...	
1111	Closing in line 312+60	

Subaddress 35h

Table 3–165: CLMPSTGY

CLMPSTGY	Clamping Strategy
D7	
0	Back-porch clamping
1	Sync-tip-clamping

Table 3–166: SLLTHDVP

SLLTHDVP	Slicing Level Threshold V Polarity
D6	
0	Positive
1	Negative

Table 3–167: SLLTHDV

SLLTHDV			Slicing Level Threshold V
D5	D4	D3	
0	0	0	No offset
0	0	1	4
0	1	0	8
0	1	1	12
1	0	0	(Reserved)
1	0	1	Adaptive (limited to ± 4)
1	1	0	Adaptive (limited to ± 8)
1	1	1	Adaptive (limited to ± 12)

Table 3–168: VFLYWHLMD

VFLYWHLMD		Vertical Flywheel Mode
D2	D1	
0	0	Check for correct standard
0	1	3 lines deviation allowed
1	0	4 lines deviation allowed, no check for interlace
1	1	5 lines deviation allowed, no check for interlace

Table 3–169: VFLYWHL

VFLYWHL	Vertical Flywheel
D0	
0	Disabled
1	Enabled

Subaddress 36h

Table 3–170: FLNSTRD

FLNSTRD		Force Line Standard at CVBS/RGB Front-end
D7	D6	
0	0	Automatic
0	1	Force 50 Hz
1	0	Force 60 Hz
1	1	(Reserved)

Table 3–171: CLMPCHARY

CLMPCHARY		Clamping Characteristic Y/CVBS: Characteristic of clamping error vs. clamping current
D5	D4	
0	0	High gain
0	1	Medium gain 1
1	0	Medium gain 2
1	1	Low gain

Table 3–172: VDETIFS

VDETIFS	Vertical Detection Slope
D3	
0	Normal
1	Slow

Table 3–173: VDETITC

VDETITC	Vertical Detection Integration Time Constant
D2	
0	Long
1	Short

Table 3–174: VLP

VLP		Lowpass for Vertical Sync-separation
D1	D0	
0	0	None
0	1	Weak
1	0	Medium
1	1	Strong

Subaddress 37h

Table 3–175: LATENCY

LATENCY		Clamping Latency: ... additional idle-states
D7	D6	
0	0	0
0	1	2
1	0	4
1	1	6

Table 3–176: FILTBRST

FILTBRST	Burst filter for Y/CVBS ADC
D5	
0	Disabled
1	Enabled

Table 3–177: CLMPIST

CLMPIST	Start of Clamping Pulse	Note
D4-D0		
00000	0.5 μ s	START=0.5 μ s+ CLMPIST *0.25 μ s
...		
11111	8.25 μ s	

Subaddress 38h

Table 3–178: CLKP_INV

CLKP_INV	Parent Clock Inversion:
D3	Controls the inversion of the parent clock
0	Not inverted
1	Inverted

Table 3–179: INCRSEL

INCRSEL	Increment Select
D3	
0	Select display clock according to HZOOM
1	Adjust display clock with DTOINCR

Table 3–180: FINECLMP

FINECLMP	Fine clamping enable
D2	
0	Use default clamping for ADC
1	Use fine clamping for ADC

Table 3–181: INSEL

INSEL		Input select
D1	D0	
0	0	Select input by CVBSEL, YUVSEL
0	1	CVBS4
1	0	Y (CVBS1), C (CVBS2)
1	1	YUV

Subaddress 39h**Table 3–182: DTOINCR**

DTOINCR	DTO increment
D7-D0	
0000000	20.25 MHz
	...
1111111	40.42 MHz

Subaddress 3Ah**Table 3–183: GPO**

GPO	GPO0-2 Pin Output Level
D4-D2	
001	GPO0 = 1, GPO1 = 0, GPO2 = 0

Table 3–184: GPOEN

GPOEN	GPO Pin Enable
D1	
0	GPO0-2 = 'Z'
1	See GPO

Table 3–185: CLKOUTEN

CLKOUTEN	Enable Clock Output CLKOUT
D0	
0	Disabled
1	Enabled

Subaddress 3Bh

Table 3–186: YSYNCOFS

YSYNCOFS	Sync Offset Enable
D0	
0	Disabled, Y or G without sync at IN2
1	Enabled, Y or G with sync at IN2

Subaddress 3Ch

Table 3–187: AFIL_OFF

AFILOFF	Anti-alias Filter Off
D5	
0	Anti-alias filter for ADCs enabled
1	Anti-alias filter for ADCs disabled

Table 3–188: STBY_REF

STBY_REF	Standby ADC Reference
D4	
0	Reference active
1	Standby

Table 3–189: STBY_OTA

STBY_OTA	Standby OTA
D3	
0	OTA active
1	Standby

Table 3–190: STBY_ADC1

STBY_ADC1	Standby ADC1
D2	
0	ADC1 active
1	Standby

Table 3–191: STBY_ADC2

STBY_ADC2	Standby ADC2
D1	
0	ADC2 active
1	Standby

Table 3–192: STBY_ADC3

STBY_ADC3	Standby ADC3
D0	
0	ADC3 active
1	Standby

Subaddress 3Dh**Table 3–193: STBY_BUFFER**

STBY_BUFFER	Standby Buffer
D7	
0	Buffer active
1	Standby

Table 3–194: STBY_CLAMP

STBY_CLAMP	Standby Clamping
D6	
0	Clamping active
1	Standby

Table 3–195: STBY_DAC1

STBY_DAC1	Standby DAC1
D5	
0	DAC1 active
1	Standby

Table 3–196: STBY_DAC2

STBY_DAC2	Standby DAC2
D4	
0	DAC2 active
1	Standby

Table 3–197: STBY_DAC3

STBY_DAC3	Standby DAC3
D3	
0	DAC3 active
1	Standby

Table 3–198: STBY_GAIN

STBY_GAIN	Standby Gain DAC
D2	
0	Gain DAC active
1	Standby

Table 3–199: STBY_OFFSET

STBY_OFFSET	Standby Offset DAC
D1	
0	Offset DAC active
1	Standby

Table 3–200: STBY_REF

STBY_REF	Standby DAC reference
D0	
0	Reference active
1	Standby

Subaddress 3Eh**Table 3–201: TRIM_BGP**

TRIM_BGP	Trim Bandgap
D7-D0	

Subaddress 3Fh**Table 3–202: PVPREV**

PVPREV		PVPA Revision
D1	D0	
0	0	Old devices
0	1	PVPA 9390
1	0	Reserved for future use
1	1	Reserved for future use

4. Specifications

4.1. Outline Dimensions

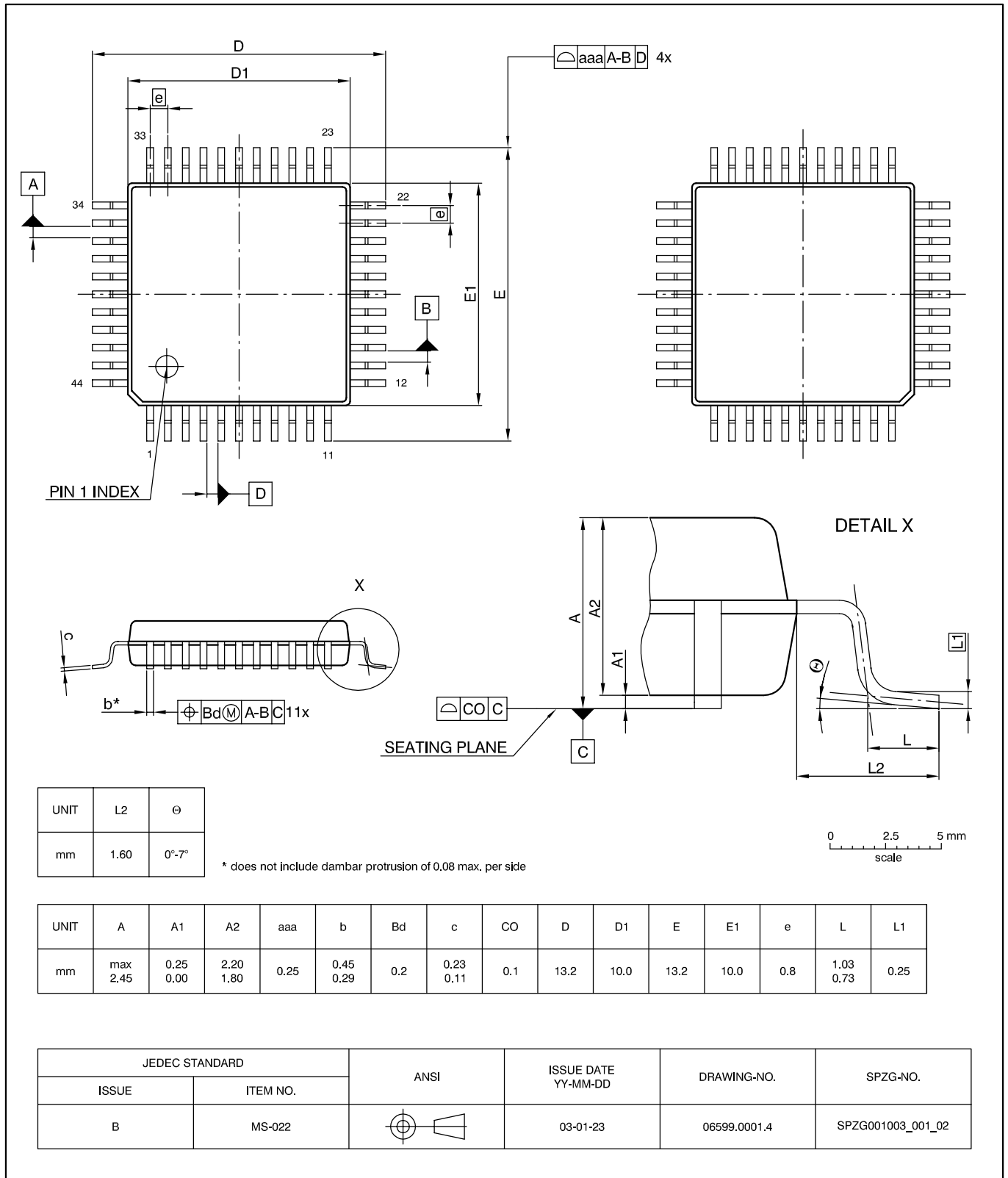

Fig. 4-1:
PMQFP44-1: Plastic Metric Quad Flat Package, 44 leads, 10 × 10 × 2 mm³
 Ordering code: QG
 Weight approximately 0.5 g

4.2. Pin Connections and Short Descriptions

NC = not connected, leave vacant

LV = if not used, leave vacant

STG = short to GND

OBL = obligatory; connect as described in circuit diagram

Pin No.	Pin Name	Type	Connection (If not used)	Short Description
1	XOUT	O	OBL	Crystal oscillator (output)
2	XIN	I	OBL	Crystal oscillator (input) or external clock input
3	VSS18	Supply	OBL	1.8 V digital core ground
4	VDD18	Supply	OBL	1.8 V digital core supply
5	GPO0	I/O	LV	General purpose output
6	SEL	O	OBL	Fast blanking output for PIP
7	OUT3	O/Analog	OBL	Analogue output: chrominance signal +(B-Y) or -(B-Y) or B
8	OUT2	O/Analog	OBL	Analogue output: luminance signal Y or G
9	OUT1	O/Analog	OBL	Analogue output: chrominance signal +(R-Y) or -(R-Y) or R
10	VSS33DAC	Supply	OBL	3.3 V DAC analog ground
11	VDD33DAC	Supply	OBL	3.3 V DAC analog supply
12	FSW	I	LV	Fast switch input for YUV/RGB switch
13	IN3	I/Analog	LV	U/B input for external YUV/RGB source
14	IN2	I/Analog	LV	Y/G input for external YUV/RGB source
15	IN1	I/Analog	LV	V/R input for external YUV/RGB source
16	VDD18ADC	Supply	OBL	1.8 V ADC analog supply
17	VSS18ADC	Supply	OBL	1.8 V ADC analog ground
18	CVBS1	I/Analog	LV	CVBS1 or Y (from YUV) input
19	TEST	I/O	STG	Reserved (tie to VSS)
20	CVBS2	I/Analog	LV	CVBS2 or U or Y (from Y/C) input
21	TM	I	STG	Test mode (tie to VSS)
22	CVBS3	I/Analog	LV	CVBS3 or V or C Input
23	CVBS4	I/Analog	LV	CVBS4
24	VSS33ADC	Supply	OBL	3.3 V ADC analog ground
25	VDD33ADC	Supply	OBL	3.3 V ADC analog supply
26	YIN	I/Analog	LV	Y input
27	UIN	I/Analog	LV	U input

Pin No.	Pin Name	Type	Connection (If not used)	Short Description
28	VIN	I/Analog	LV	V input
29	RESET	I	OBL	Asynchronous reset input
30	VDD18	Supply	OBL	1.8 V digital core supply
31	VSS18	Supply	OBL	1.8 V digital core ground
32	POR	O	LV	Reserved (open)
33	GPO2	I/O	LV	General purpose output
34	I2C1	I	OBL	I ² C Address 1
35	I2C2	I	OBL	I ² C Address 2
36	SDA	I/O	OBL	I ² C-bus data
37	SCL	I	OBL	I ² C-bus clock
38	INTR	O	LV	Interrupt output
39	VDD33PAD	Supply	OBL	3.3 V digital pad supply
40	VSS33PAD	Supply	OBL	3.3 V digital pad ground
41	VSP	I	OBL	Vertical sync for parent channel
42	HSP	I	OBL	Horizontal sync for parent channel
43	GPO1	I/O	LV	General purpose output
44	CLKOUT	O	LV	Clock output

4.3. Pin Configurations

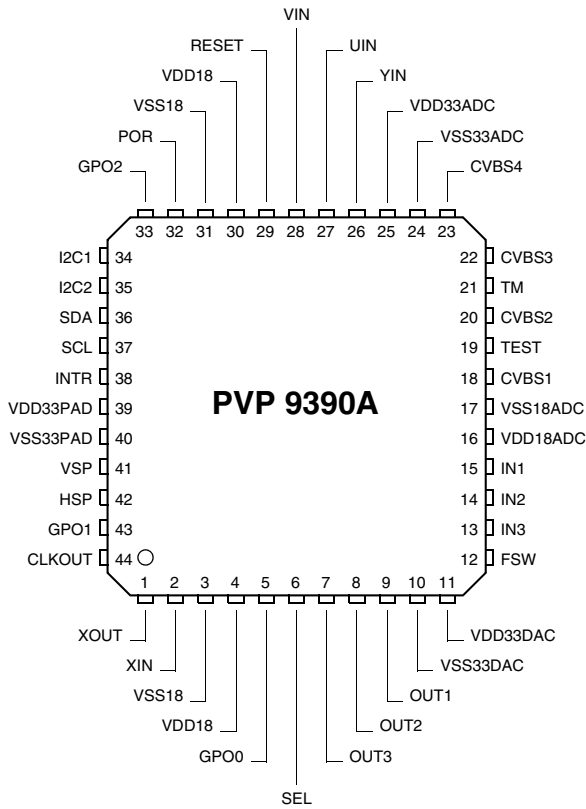

Fig. 4-2: PMQFP44-1 Package

4.4. Electrical Characteristics

Abbreviations:

tbd = to be defined

vacant = not applicable

positive current values mean current flowing into the chip

4.4.1. Absolute Maximum Ratings

Stresses beyond those listed in the “Absolute Maximum Ratings” may cause permanent damage to the device. This is a stress rating only. Functional operation of the device at these conditions is not implied. Exposure to absolute maximum rating conditions for extended periods will affect device reliability.

This device contains circuitry to protect the inputs and outputs against damage due to high static voltages or electric fields; however, it is advised that normal precautions be taken to avoid application of any voltage higher than absolute maximum-rated voltages to this high-impedance circuit.

All voltages listed are referenced to ground (VSS18, VSS33PAD, VSS33DAC, VSS18ADC, VSS33ADC) except where noted.

All GND pins must be connected to a low-resistive ground plane close to the IC.

Table 4–1: Absolute Maximum Ratings

Symbol	Parameter	Pin Name	Limit Values		Unit
			Min.	Max.	
T_A ¹⁾	Ambient Operating Temperature PMQFP44-1		-10	70 ²⁾	°C
T_C	Case Operating Temperature PMQFP44-1		-10	115	°C
T_S	Storage Temperature		-40	125	°C
P_{max}	Maximum Power Dissipation Package PMQFP44-1			750	mW
V_{SUP1}	Supply Voltage 1	VDD33DAC, VDD33ADC, VDD33PAD	-0.3	3.63	V
V_{SUP2}	Supply Voltage 2	VDD18, VDD18ADC	-0.3	1.98	V
ΔV_{SUP}	Voltage Differences within Supply Domains		-0.25	0.25	V
V_I	Input Voltage	All except power supply	-0.3	$V_{SUP1}+0.3$ V	V
V_O	Output Voltage	All except power supply	-0.3	$V_{SUP1}+0.3$ V	V

¹⁾ Measured on Micronas typical 2-layer (1s1p) board based on JESD - 51.2 Standard with maximum power consumption allowed for this package.

²⁾ A power-optimized board layout is recommended. The Case Operating Temperature mentioned in the Absolute Maximum Ratings must not be exceeded at worst case conditions of the application

4.4.2. Recommended Operating Conditions

Functional operation of the device beyond those indicated in the “Recommended Operating Conditions/Characteristics” is not implied and may result in unpredictable behavior, reduce reliability and lifetime of the device.

All voltages listed are referenced to ground (VSS18, VSS33PAD, VSS33DAC, VSS18ADC, VSS33ADC) except where noted.

All GND pins must be connected to a low-resistive ground plane close to the IC.

Do not insert the device into a live socket. Instead, apply power by switching on the external power supply.

Symbol	Parameter	Pin Name	Limit Values			Unit
			Min.	Typ.	Max.	
T_A	Ambient Operating Temperature Package PMQFP44-1		0	25	70 ¹⁾	°C
T_C	Case Operating Temperature Package PMQFP44-1		5 ²⁾	45 ³⁾	95 ⁴⁾	°C
P_{max}	Maximum Power Dissipation Package PMQFP44-1				400	mW
V_{SUP1}	Supply Voltage 1	VDD33DAC, VDD33ADC, VDD33PAD	3.13	3.3	3.46	V
V_{SUP2}	Supply Voltage 2	VDD18, VDD18ADC	1.71	1.8	1.89	V
ΔV_{SUP}	Voltage Differences within Supply Domains		-0.25		0.25	V
V_{IL}	Input Voltage Low				0.8	V
V_{IH}	Input Voltage High		2.0			V
<p>¹⁾ A power-optimized board layout is recommended. The Case Operating Temperatures mentioned in the “Recommended Operating Conditions” must not be exceeded at worst case conditions of the application.</p> <p>²⁾ By T_{Amin} and 300 mW</p> <p>³⁾ By $T_A=25^\circ\text{C}$ and 350 mW</p> <p>⁴⁾ By T_{Amax} and 400 mW</p>						

4.4.3. Recommended Crystal Characteristics

Symbol	Parameter	Pin Name	Limit Values		Unit
			Min.	Max.	
f_{xtal}	Frequency (Deviation outside this range will cause color decoding failures)	XIN, XOUT	20.248	20.25	20.252
$\Delta f_{\text{max}}/f_{\text{xtal}}$	Maximum Permissible Frequency Deviation (Deviation outside this range will cause color decoding failures)		-100		100
$\Delta f/f_{\text{xtal}}$	Recommended Permissible Frequency Deviation		-40	0	40
C_L	Load Capacitance		12	27	39
R_S	Series Resonance Resistance			25	
C_1	Motional Capacitance			27	
C_0	Parallel Capacitance			7	
In the operating range the function given in the circuit description are fulfilled.					

5. Application

5.1. Application Circuit

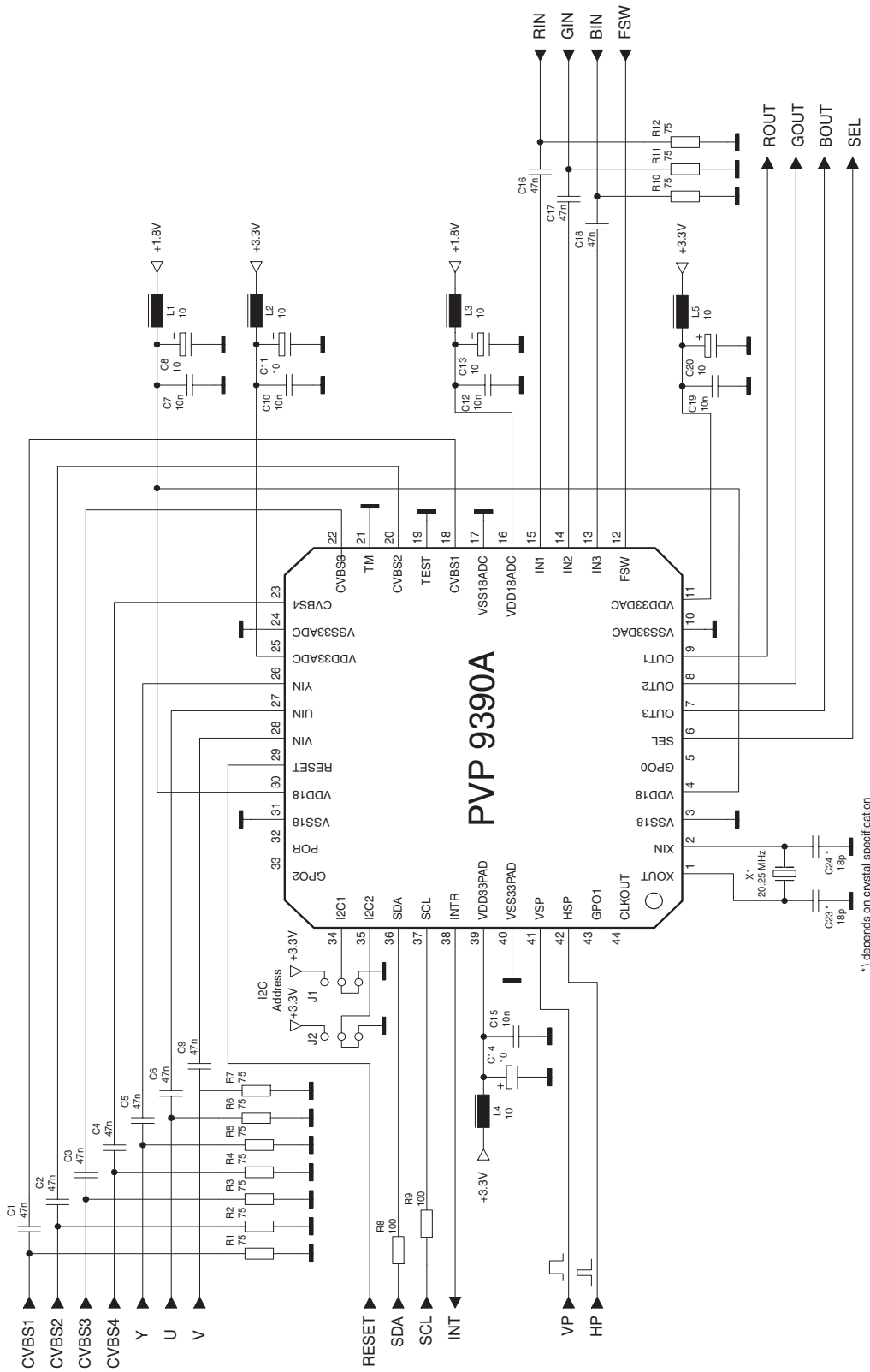

*) depends on crystal specification

Fig. 5-1: Application Circuit

6. Data Sheet History

1. Advance Information: "PVP 9390A Picture-in-Picture IC", May 3, 2004, 6251-633-1AI. First release of the advance information.

Micronas GmbH
Hans-Bunte-Strasse 19
D-79108 Freiburg (Germany)
P.O. Box 840
D-79008 Freiburg (Germany)
Tel. +49-761-517-0
Fax +49-761-517-2174
E-mail: docservice@micronas.com
Internet: www.micronas.com

Printed in Germany
Order No. 6251-633-1AI

All information and data contained in this data sheet are without any commitment, are not to be considered as an offer for conclusion of a contract, nor shall they be construed as to create any liability. Any new issue of this data sheet invalidates previous issues. Product availability and delivery are exclusively subject to our respective order confirmation form; the same applies to orders based on development samples delivered. By this publication, Micronas GmbH does not assume responsibility for patent infringements or other rights of third parties which may result from its use.

Further, Micronas GmbH reserves the right to revise this publication and to make changes to its content, at any time, without obligation to notify any person or entity of such revisions or changes.

No part of this publication may be reproduced, photocopied, stored on a retrieval system, or transmitted without the express written consent of Micronas GmbH.