

FEATURES

- Low Noise:** 80 nV p-p (0.1 Hz to 10 Hz), $3 \text{ nV}/\sqrt{\text{Hz}}$
- Low Drift:** $0.2 \mu\text{V}/^\circ\text{C}$
- High Speed:** $2.8 \text{ V}/\mu\text{s}$ Slew Rate, 8 MHz Gain Bandwidth
- Low V_{OS} :** $10 \mu\text{V}$
- Excellent CMRR:** 126 dB at V_{CM} of $\pm 11 \text{ V}$
- High Open-Loop Gain:** 1.8 Million
- Fits 725, OP07, 5534A Sockets**
- Available in Die Form**

GENERAL DESCRIPTION

The OP27 precision operational amplifier combines the low offset and drift of the OP07 with both high speed and low noise. Offsets down to $25 \mu\text{V}$ and drift of $0.6 \mu\text{V}/^\circ\text{C}$ maximum make the OP27 ideal for precision instrumentation applications. Exceptionally low noise, $e_n = 3.5 \text{ nV}/\sqrt{\text{Hz}}$, at 10 Hz, a low $1/f$ noise corner frequency of 2.7 Hz, and high gain (1.8 million), allow accurate high-gain amplification of low-level signals. A gain-bandwidth product of 8 MHz and a $2.8 \text{ V}/\mu\text{sec}$ slew rate provides excellent dynamic accuracy in high-speed, data-acquisition systems.

A low input bias current of $\pm 10 \text{ nA}$ is achieved by use of a bias-current-cancellation circuit. Over the military temperature range, this circuit typically holds I_B and I_{OS} to $\pm 20 \text{ nA}$ and 15 nA , respectively.

The output stage has good load driving capability. A guaranteed swing of $\pm 10 \text{ V}$ into 600Ω and low output distortion make the OP27 an excellent choice for professional audio applications.

(Continued on page 7)

PIN CONNECTIONS

TO-99
(J-Suffix)

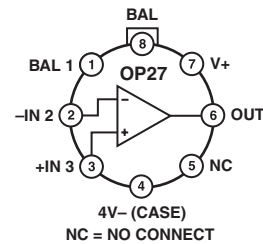

8-Pin Hermetic DIP
(Z-Suffix)
Epoxy Mini-DIP
(P-Suffix)
8-Pin SO
(S-Suffix)

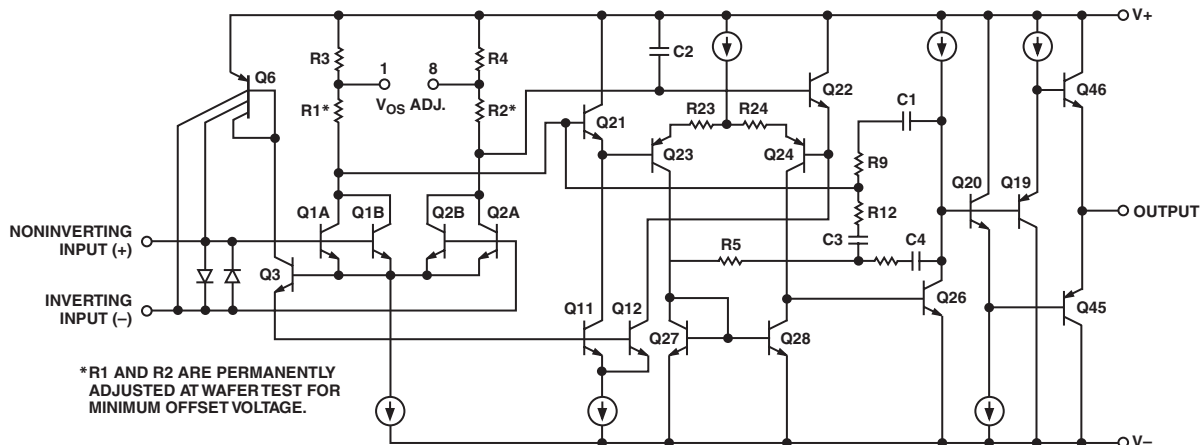
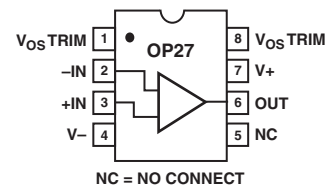

Figure 1. Simplified Schematic

REV. A

Information furnished by Analog Devices is believed to be accurate and reliable. However, no responsibility is assumed by Analog Devices for its use, nor for any infringements of patents or other rights of third parties that may result from its use. No license is granted by implication or otherwise under any patent or patent rights of Analog Devices.

OP27—SPECIFICATIONS

ELECTRICAL CHARACTERISTICS (@ $V_S = \pm 15\text{ V}$, $T_A = 25^\circ\text{C}$, unless otherwise noted.)

Parameter	Symbol	Conditions	OP27A/E			OP27F			OP27C/G			Unit
			Min	Typ	Max	Min	Typ	Max	Min	Typ	Max	
INPUT OFFSET VOLTAGE ¹	V_{OS}		10	25		20	60		30	100	μV	
LONG-TERM V_{OS} STABILITY ^{2,3}	V_{OS}/Time		0.2	1.0		0.3	1.5		0.4	2.0	$\mu\text{V}/\text{M}_O$	
INPUT OFFSET CURRENT	I_{OS}		7	35		9	50		12	75	nA	
INPUT BIAS CURRENT	I_B		± 10	± 40		± 12	± 55		± 15	± 80	nA	
INPUT NOISE VOLTAGE ^{3,4}	$e_{n\text{ p-p}}$	0.1 Hz to 10 Hz	0.08	0.18		0.08	0.18		0.09	0.25	$\mu\text{V p-p}$	
INPUT NOISE Voltage Density ³	e_n	$f_o = 10\text{ Hz}$ $f_o = 30\text{ Hz}$ $f_o = 1000\text{ Hz}$	3.5 3.1 3.0	5.5 4.5 3.8		3.5 3.1 3.0	5.5 4.5 3.8		3.8 3.3 3.2	8.0 5.6 4.5	$\text{nV}/\sqrt{\text{Hz}}$ $\text{nV}/\sqrt{\text{Hz}}$ $\text{nV}/\sqrt{\text{Hz}}$	
INPUT NOISE Current Density ^{3,5}	i_n	$f_o = 10\text{ Hz}$ $f_o = 30\text{ Hz}$ $f_o = 1000\text{ Hz}$	1.7 1.0 0.4	4.0 2.3 0.6		1.7 1.0 0.4	4.0 2.3 0.6		1.7 1.0 0.4	0.6	$\text{pA}/\sqrt{\text{Hz}}$ $\text{pA}/\sqrt{\text{Hz}}$ $\text{pA}/\sqrt{\text{Hz}}$	
INPUT RESISTANCE Differential-Mode ⁶ Common-Mode	R_{IN} R_{INCM}		1.3 3	6		0.94 2.5	5		0.7 2	4	$\text{M}\Omega$ $\text{G}\Omega$	
INPUT VOLTAGE RANGE	IVR		± 11.0	± 12.3		± 11.0	± 12.3		± 11.0	± 12.3	V	
COMMON-MODE REJECTION RATIO	CMRR	$V_{CM} = \pm 11\text{ V}$	114	126		106	123		100	120	dB	
POWER SUPPLY REJECTION RATIO	PSRR	$V_S = \pm 4\text{ V}$ to $\pm 18\text{ V}$	1	10		1	10		2	20	$\mu\text{V}/\text{V}$	
LARGE-SIGNAL VOLTAGE GAIN	A_{VO}	$R_L \geq 2\text{ k}\Omega$, $V_O = \pm 10\text{ V}$ $R_L \geq 600\ \Omega$, $V_O = \pm 10\text{ V}$	1000 800	1800 1500		1000 800	1800 1500		700 600	1500 1500	V/mV V/mV	
OUTPUT VOLTAGE SWING	V_O	$R_L \geq 2\text{ k}\Omega$ $R_L \geq 600\ \Omega$	± 12.0 ± 10.0	± 13.8 ± 11.5		± 12.0 ± 10.0	± 13.8 ± 11.5		± 11.5 ± 10.0	± 13.5 ± 11.5	V V	
SLEW RATE ⁷	SR	$R_L \geq 2\text{ k}\Omega$	1.7	2.8		1.7	2.8		1.7	2.8	V/ μs	
GAIN BANDWIDTH PRODUCT ⁷	GBW		5.0	8.0		5.0	8.0		5.0	8.0	MHz	
OPEN-LOOP OUTPUT RESISTANCE	R_O	$V_O = 0$, $I_O = 0$	70			70			70		Ω	
POWER CONSUMPTION	P_d	V_O	90	140		90	140		100	170	mW	
OFFSET ADJUSTMENT RANGE		$R_p = 10\text{ k}\Omega$	± 4.0			± 4.0			± 4.0		mV	

NOTES

¹Input offset voltage measurements are performed ~ 0.5 seconds after application of power. A/E grades guaranteed fully warmed up.

²Long-term input offset voltage stability refers to the average trend line of V_{OS} versus. Time over extended periods after the first 30 days of operation. Excluding the initial hour of operation, changes in V_{OS} during the first 30 days are typically $2.5\ \mu\text{V}$. Refer to typical performance curve.

³Sample tested.

⁴See test circuit and frequency response curve for 0.1 Hz to 10 Hz tester.

⁵See test circuit for current noise measurement.

⁶Guaranteed by input bias current.

⁷Guaranteed by design.

ELECTRICAL CHARACTERISTICS (@ $V_S = \pm 15\text{ V}$, $-55^\circ\text{C} \leq T_A \leq 125^\circ\text{C}$, unless otherwise noted.)

Parameter	Symbol	Conditions	OP27A			OP27C			Unit
			Min	Typ	Max	Min	Typ	Max	
INPUT OFFSET VOLTAGE ¹	V_{OS}			30	60		70	300	μV
AVERAGE INPUT OFFSET DRIFT	TCV_{OS}^2 TCV_{OSn}^3			0.2	0.6		4	1.8	$\mu\text{V}/^\circ\text{C}$
INPUT OFFSET CURRENT	I_{OS}			15	50		30	135	nA
INPUT BIAS CURRENT	I_B			± 20	± 60		± 35	± 150	nA
INPUT VOLTAGE RANGE	IVR		± 10.3	± 11.5		± 10.2	± 11.5		V
COMMON-MODE REJECTION RATIO	CMRR	$V_{CM} = \pm 10\text{ V}$	108	122		94	118		dB
POWER SUPPLY REJECTION RATIO	PSRR	$V_S = \pm 4.5\text{ V}$ to $\pm 18\text{ V}$		2	16		4	51	$\mu\text{V}/\text{V}$
LARGE-SIGNAL VOLTAGE GAIN	A_{VO}	$R_L \geq 2\text{ k}\Omega$, $V_O = \pm 10\text{ V}$	600	1200		300	800		V/mV
OUTPUT VOLTAGE SWING	V_O	$R_L \geq 2\text{ k}\Omega$	± 11.5	± 13.5		± 10.5	± 13.0		V

NOTES

¹Input offset voltage measurements are performed by automated test equipment approximately 0.5 seconds after application of power. A/E grades guaranteed fully warmed up.

²The TCV_{OS} performance is within the specifications unnullled or when nullled with $R_P = 8\text{ k}\Omega$ to $20\text{ k}\Omega$. TCV_{OS} is 100% tested for A/E grades, sample tested for C/F/G grades.

³Guaranteed by design.

OP27

ELECTRICAL CHARACTERISTICS

(@ $V_S = \pm 15\text{ V}$, $-25^\circ\text{C} \leq T_A \leq 85^\circ\text{C}$ for OP27J, OP27Z, $0^\circ\text{C} \leq T_A \leq 70^\circ\text{C}$ for OP27EP, OP27FP, and $-40^\circ\text{C} \leq T_A \leq 85^\circ\text{C}$ for OP27GP, OP27GS, unless otherwise noted.)

Parameter	Symbol	Conditions	OP27E			OP27F			OP27G			Unit
			Min	Typ	Max	Min	Typ	Max	Min	Typ	Max	
INPUT ONSET VOLTAGE	V_{OS}			20	50		40	140		55	220	μV
AVERAGE INPUT OFFSET DRIFT	TCV_{OS}^1 TCV_{OSn}^2			0.2	0.6		0.3	1.3		0.4	1.8	$\mu\text{V}/^\circ\text{C}$
				0.2	0.6		0.3	1.3		0.4	1.8	$\mu\text{V}/^\circ\text{C}$
INPUT OFFSET CURRENT	I_{OS}			10	50		14	85		20	135	nA
INPUT BIAS CURRENT	I_B			± 14	± 60		± 18	± 95		± 25	± 150	nA
INPUT VOLTAGE RANGE	IVR		± 10.5	± 11.8		± 10.5	± 11.8		± 10.5	± 11.8		V
COMMON-MODE REJECTION RATIO	CMRR	$V_{CM} = \pm 10\text{ V}$	110	124		102	121		96	118		dB
POWER SUPPLY REJECTION RATIO	PSRR	$V_S = \pm 4.5\text{ V}$ to $\pm 18\text{ V}$		2	15		2	16		2	32	$\mu\text{V}/\text{V}$
LARGE-SIGNAL VOLTAGE GAIN	A_{VO}	$R_L \geq 2\text{ k}\Omega$, $V_O = \pm 10\text{ V}$	750	1500		700	1300		450	1000		V/mV
OUTPUT VOLTAGE SWING	V_O	$R_L \geq 2\text{ k}\Omega$	± 11.7	± 13.6		± 11.4	± 13.5		± 11.0	± 13.3		V

NOTES

¹The TCV_{OS} performance is within the specifications unnullled or when nullled with $R_p = 8\text{ k}\Omega$ to $20\text{ k}\Omega$. TCV_{OS} is 100% tested for A/E grades, sample tested for C/F/G grades.

²Guaranteed by design.

DICE CHARACTERISTICS

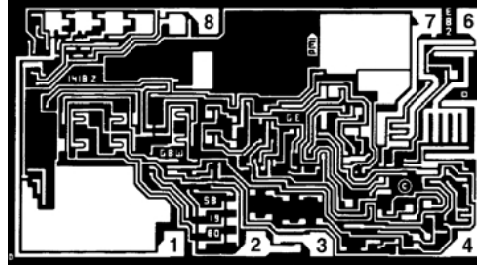

- 1. NULL
- 2. (-) INPUT
- 3. (+) INPUT
- 4. V-
- 6. OUTPUT
- 7. V+
- 8. NULL

DIE SIZE 0.109 × 0.055 INCH, 5995 SQ. MILS
(2.77 × 1.40mm, 3.88 SQ. mm)

WAFER TEST LIMITS (@ $V_S = \pm 15\text{ V}$, $T_A = 25^\circ\text{C}$ unless otherwise noted.)

Parameter	Symbol	Conditions	OP27N Limit	OP27G Limit	OP27GR Limit	Unit
INPUT OFFSET VOLTAGE*	V_{OS}		35	60	100	μV Max
INPUT OFFSET CURRENT	I_{OS}		35	50	75	nA Max
INPUT BIAS CURRENT	IB		± 40	± 55	± 80	nA Max
INPUT VOLTAGE RANGE	IVR		± 11	± 11	± 11	V Min
COMMON-MODE REJECTION RATIO	CMRR	$V_{CM} = \text{IVR}$	114	106	100	dB Min
POWER SUPPLY	PSRR	$V_S = \pm 4\text{ V}$ to $\pm 18\text{ V}$	10	10	20	$\mu\text{V/V}$ Max
LARGE-SIGNAL VOLTAGE GAIN	A_{VO}	$R_L \geq 2\text{ k}\Omega$, $V_O = \pm 10\text{ V}$	1000	1000	700	V/mV Min
	A_{VO}	$R_L \geq 600\ \Omega$, $V_O = \pm 10\text{ V}$	800	800	600	V/mV Min
OUTPUT VOLTAGE SWING	V_O	$R_L \geq 2\text{ k}\Omega$	± 12.0	± 12.0	+11.5	V Min
	V_O	RL2600n	± 10.0	± 10.0	± 10.0	V Min
POWER CONSUMPTION	P_d	$V_O = 0$	140	140	170	mW Max

NOTE

*Electrical tests are performed at wafer probe to the limits shown. Due to variations in assembly methods and normal yield loss, yield after packaging is not guaranteed for standard product dice. Consult factory to negotiate specifications based on dice lot qualification through sample lot assembly and testing.

OP27

TYPICAL ELECTRICAL CHARACTERISTICS (@ $V_S = \pm 15\text{ V}$, $T_A = 25^\circ\text{C}$ unless otherwise noted.)

Parameter	Symbol	Conditions	OP27N Typical	OP27G Typical	OP27GR Typical	Unit
AVERAGE INPUT OFFSET VOLTAGE DRIFT*	TCV_{OS} or TCV_{OSn}	Nulled or Unnulled $R_P = 8\text{ k}\Omega$ to $20\text{ k}\Omega$	0.2	0.3	0.4	$\mu\text{V}/^\circ\text{C}$
AVERAGE INPUT OFFSET CURRENT DRIFT	TCI_{OS}		80	130	180	$\text{pA}/^\circ\text{C}$
AVERAGE INPUT BIAS CURRENT DRIFT	TCI_B		100	160	200	$\text{pA}/^\circ\text{C}$
INPUT NOISE VOLTAGE DENSITY	e_n	$f_O = 10\text{ Hz}$	3.5	3.5	3.8	$\text{nV}/\sqrt{\text{Hz}}$
	e_n	$f_O = 30\text{ Hz}$	3.1	3.1	3.3	$\text{nV}/\sqrt{\text{Hz}}$
	e_n	$f_O = 1000\text{ Hz}$	3.0	3.0	3.2	$\text{nV}/\sqrt{\text{Hz}}$
INPUT NOISE CURRENT DENSITY	i_n	$f_O = 10\text{ Hz}$	1.7	1.7	1.7	$\text{pA}/\sqrt{\text{Hz}}$
	i_n	$f_O = 30\text{ Hz}$	1.0	1.0	1.0	$\text{pA}/\sqrt{\text{Hz}}$
	i_n	$f_O = 1000\text{ Hz}$	0.4	0.4	0.4	$\text{pA}/\sqrt{\text{Hz}}$
INPUT NOISE VOLTAGE SLEW RATE	e_{np-p}	0.1 Hz to 10 Hz	0.08	0.08	0.09	$\mu\text{V p-p}$
	SR	$R_L \geq 2\text{ k}\Omega$	2.8	2.8	2.8	$\text{V}/\mu\text{s}$
GAIN BANDWIDTH PRODUCT	GBW		8	8	8	MHz

NOTE

*Input offset voltage measurements are performed by automated test equipment approximately 0.5 seconds after application of power.

(Continued from page 1)

PSRR and CMRR exceed 120 dB. These characteristics, coupled with long-term drift of 0.2 $\mu\text{V}/\text{month}$, allow the circuit designer to achieve performance levels previously attained only by discrete designs.

Low-cost, high-volume production of OP27 is achieved by using an on-chip Zener zap-trimming network. This reliable and stable offset trimming scheme has proved its effectiveness over many years of production history.

The OP27 provides excellent performance in low-noise, high-accuracy amplification of low-level signals. Applications include stable integrators, precision summing amplifiers, precision voltage-threshold detectors, comparators, and professional audio circuits such as tape-head and microphone preamplifiers.

The OP27 is a direct replacement for 725, OP06, OP07, and OP45 amplifiers; 741 types may be directly replaced by removing the 741's nulling potentiometer.

ABSOLUTE MAXIMUM RATINGS⁴

Supply Voltage	$\pm 22\text{ V}$
Input Voltage ¹	$\pm 22\text{ V}$
Output Short-Circuit Duration	Indefinite
Differential Input Voltage ²	$\pm 0.7\text{ V}$
Differential Input Current ²	$\pm 25\text{ mA}$
Storage Temperature Range	-65°C to $+150^\circ\text{C}$
Operating Temperature Range	
OP27A, OP27C (J, Z)	-55°C to $+125^\circ\text{C}$
OP27E, OP27F (J, Z)	-25°C to $+85^\circ\text{C}$
OP27E, OP27F (P)	0°C to 70°C
OP27G (P, S, J, Z)	-40°C to $+85^\circ\text{C}$
Lead Temperature Range (Soldering, 60 sec)	300°C
Junction Temperature	-65°C to $+150^\circ\text{C}$

Package Type	θ_{JA} ³	θ_{JC}	Unit
TO 99 (J)	150	18	$^\circ\text{C}/\text{W}$
8-Lead Hermetic DIP (Z)	148	16	$^\circ\text{C}/\text{W}$
8-Lead Plastic DIP (P)	103	43	$^\circ\text{C}/\text{W}$
20-Contact LCC (RC)	98	38	$^\circ\text{C}/\text{W}$
8-Lead SO (S)	158	43	$^\circ\text{C}/\text{W}$

NOTES

¹For supply voltages less than $\pm 22\text{ V}$, the absolute maximum input voltage is equal to the supply voltage.

²The OP27's inputs are protected by back-to-back diodes. Current limiting resistors are not used in order to achieve low noise. If differential input voltage exceeds $\pm 0.7\text{ V}$, the input current should be limited to 25 mA.

³ θ_{JA} is specified for worst-case mounting conditions, i.e., θ_{JA} is specified for device in socket for TO, Cerdip, and P-DIP packages; θ_{JA} is specified for device soldered to printed circuit board for SO package.

⁴Absolute Maximum Ratings apply to both DICE and packaged parts, unless otherwise noted.

ORDERING INFORMATION¹

$T_A = 25^\circ\text{C}$ $V_{OS\text{ Max}}$ (μV)	Package			Operating Temperature Range
	TO-99	CERDIP 8-Lead	Plastic 8-Lead	
25	OP27AJ ^{2,3}	OP27AZ ²		MIL
25	OP27EJ ^{2,3}	OP27EZ	OP27EP	IND/COM
60			OP27FP ³	IND/COM
100		OP27CZ ³		MIL
100	OP27GJ	OP27GZ	OP27GP	XIND
100			OP27GS ⁴	XIND

NOTES

¹Burn-in is available on commercial and industrial temperature range parts in CERDIP, plastic DIP, and TO-can packages.

²For devices processed in total compliance to MIL-STD-883, add /883 after part number. Consult factory for 883 data sheet.

³Not for new design; obsolete April 2002.

⁴For availability and burn-in information on SO and PLCC packages, contact your local sales office.

CAUTION

ESD (electrostatic discharge) sensitive device. Electrostatic charges as high as 4000 V readily accumulate on the human body and test equipment and can discharge without detection. Although the OP27 features proprietary ESD protection circuitry, permanent damage may occur on devices subjected to high-energy electrostatic discharges. Therefore, proper ESD precautions are recommended to avoid performance degradation or loss of functionality.



OP27—Typical Performance Characteristics

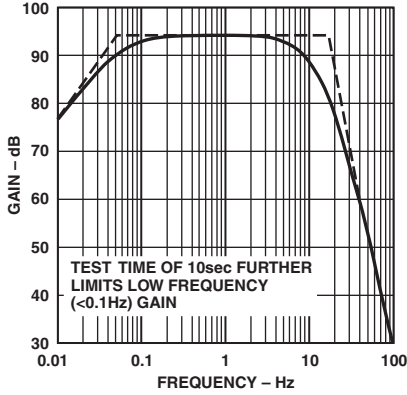

TPC 1. 0.1 Hz to 10 Hz_{p-p} Noise Tester Frequency Response

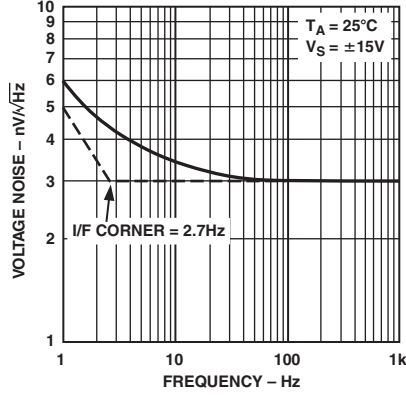

TPC 2. Voltage Noise Density vs. Frequency

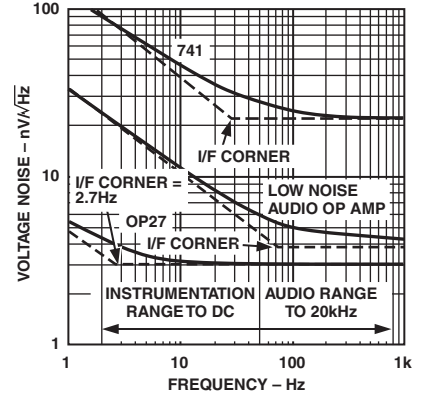

TPC 3. A Comparison of Op Amp Voltage Noise Spectra

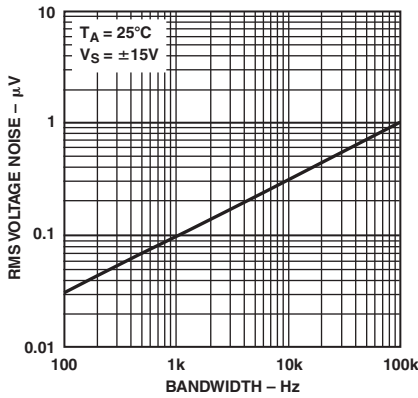

TPC 4. Input Wideband Voltage Noise vs. Bandwidth (0.1 Hz to Frequency Indicated)

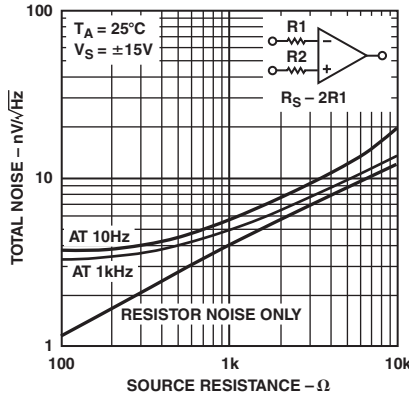

TPC 5. Total Noise vs. Sourced Resistance

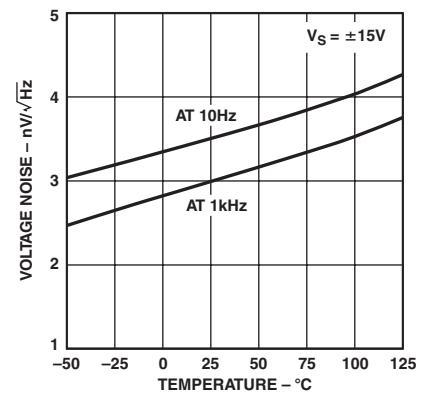

TPC 6. Voltage Noise Density vs. Temperature

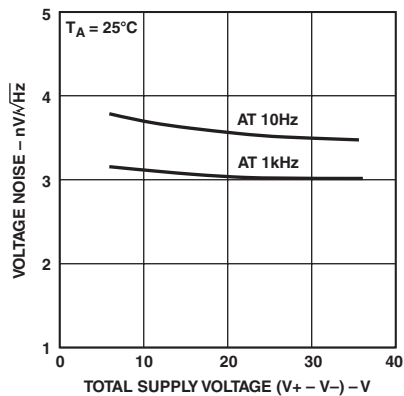

TPC 7. Voltage Noise Density vs. Supply Voltage

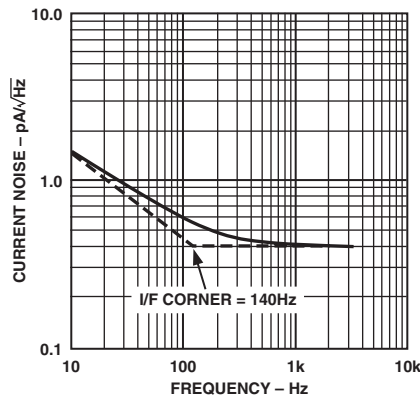

TPC 8. Current Noise Density vs. Frequency

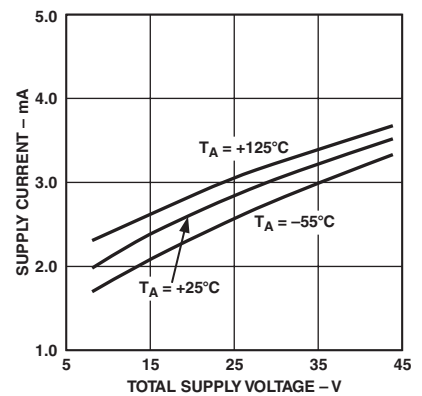

TPC 9. Supply Current vs. Supply Voltage

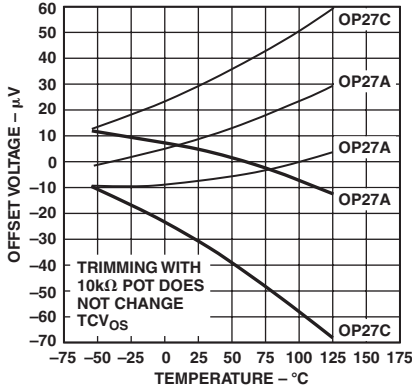

TPC 10. Offset Voltage Drift of Five Representative Units vs. Temperature

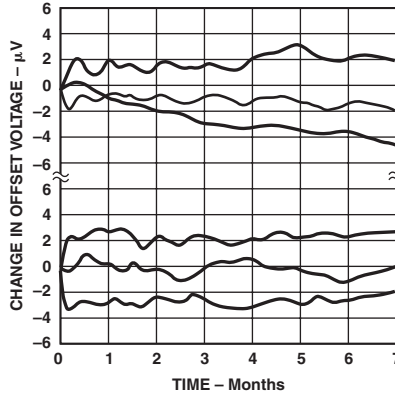

TPC 11. Long-Term Offset Voltage Drift of Six Representative Units

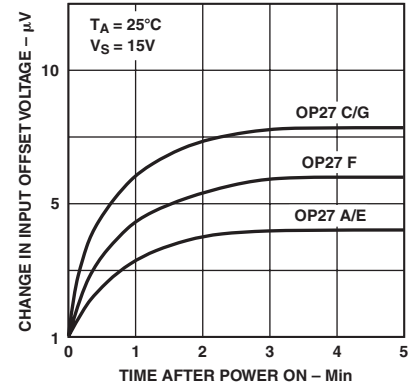

TPC 12. Warm-Up Offset Voltage Drift

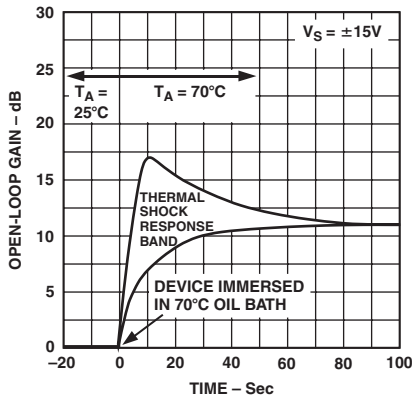

TPC 13. Offset Voltage Change Due to Thermal Shock

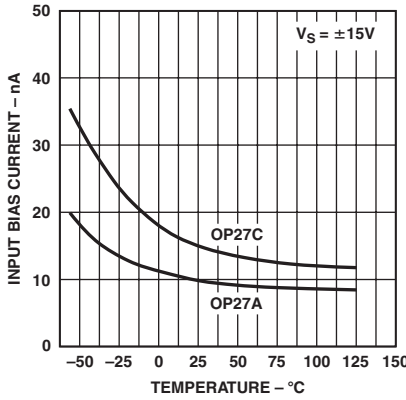

TPC 14. Input Bias Current vs. Temperature

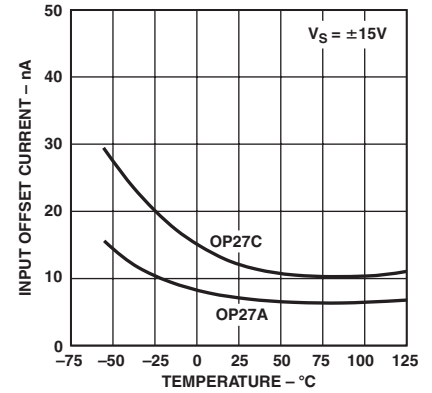

TPC 15. Input Offset Current vs. Temperature

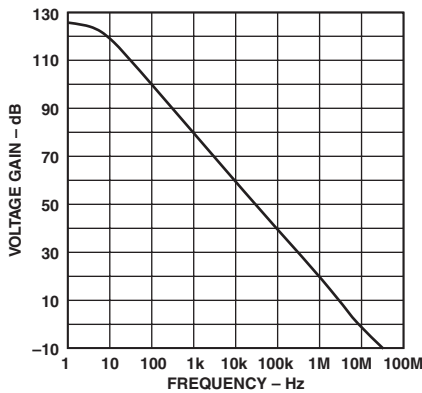

TPC 16. Open-Loop Gain vs. Frequency

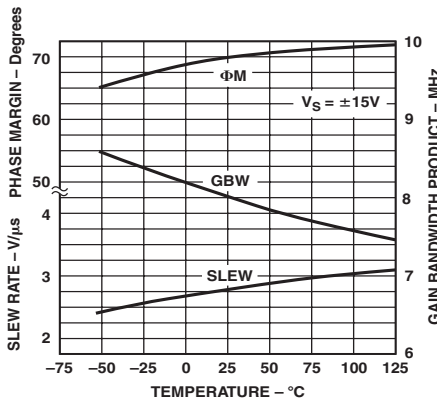

TPC 17. Slew Rate, Gain-Bandwidth Product, Phase Margin vs. Temperature

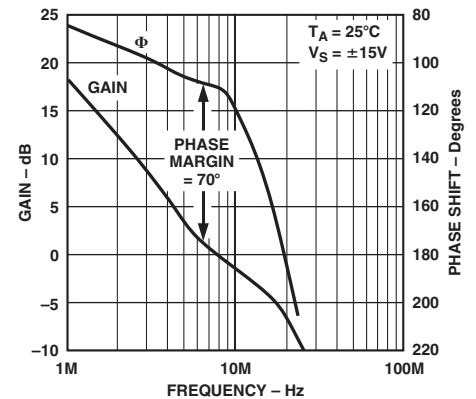

TPC 18. Gain, Phase Shift vs. Frequency

OP27

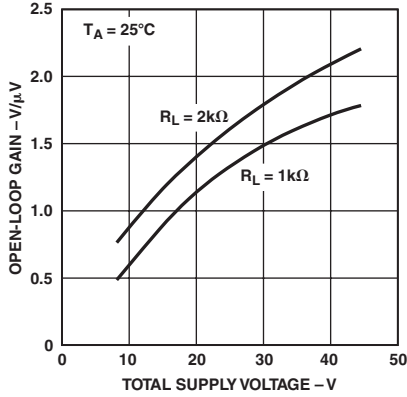

TPC 19. Open-Loop Voltage Gain vs. Supply Voltage

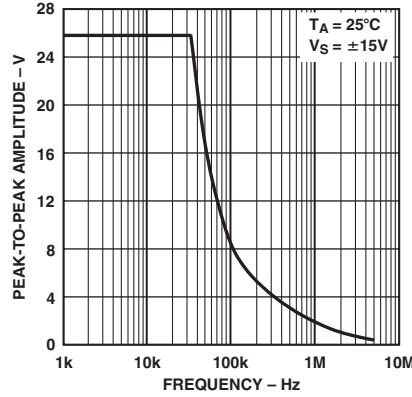

TPC 20. Maximum Output Swing vs. Frequency

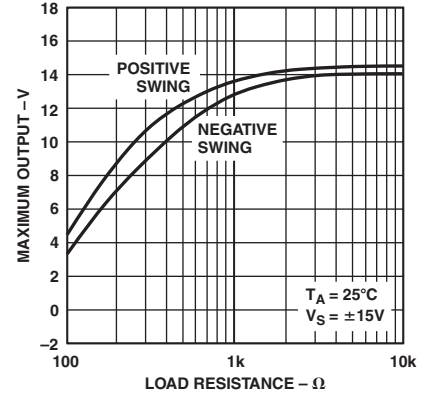

TPC 21. Maximum Output Voltage vs. Load Resistance

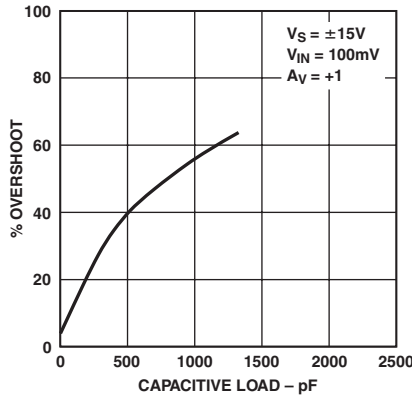

TPC 22. Small-Signal Overshoot vs. Capacitive Load

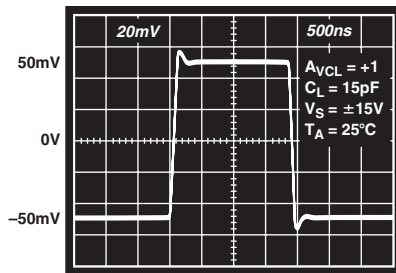

TPC 23. Small-Signal Transient Response

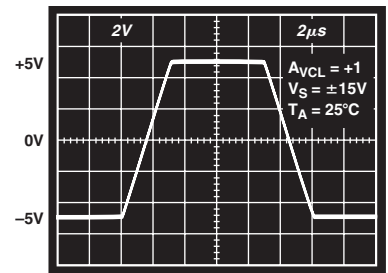

TPC 24. Large-Signal Transient Response

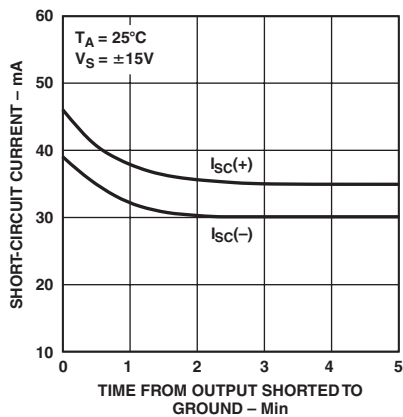

TPC 25. Short-Circuit Current vs. Time

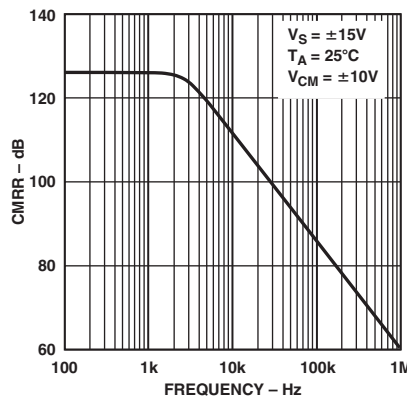

TPC 26. CMRR vs. Frequency

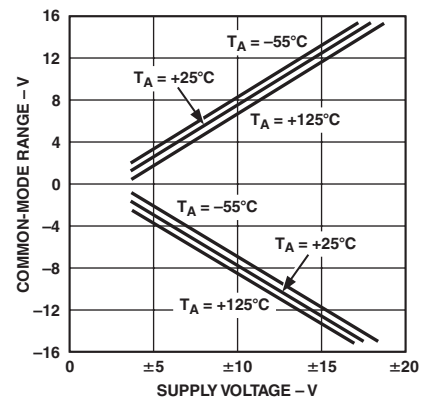

TPC 27. Common-Mode Input Range vs. Supply Voltage

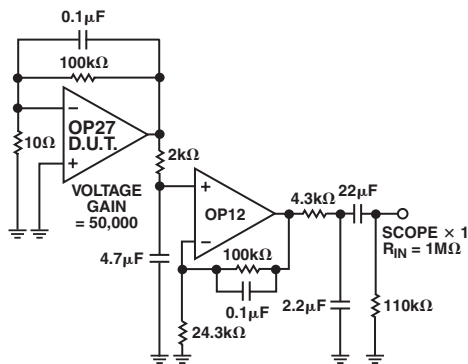

TPC 28. Voltage Noise Test Circuit (0.1 Hz to 10 Hz)

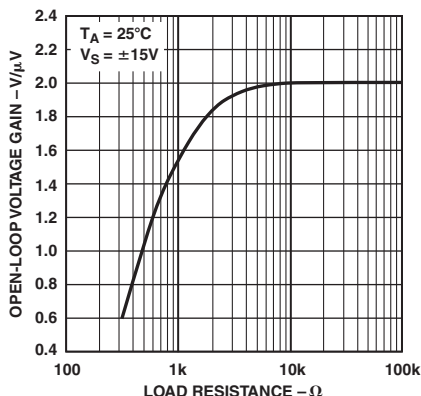

TPC 29. Open-Loop Voltage Gain vs. Load Resistance

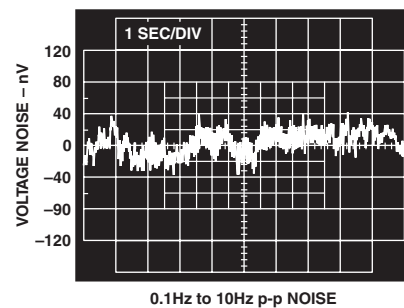

TPC 30. Low-Frequency Noise

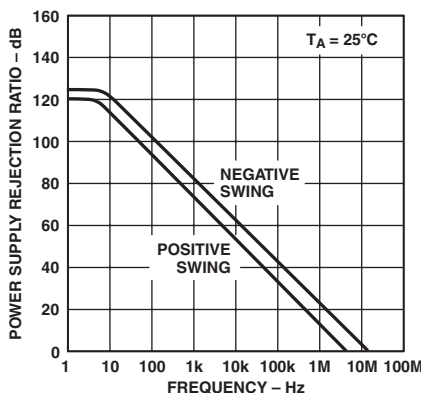

TPC 31. PSRR vs. Frequency

APPLICATION INFORMATION

OP27 series units may be inserted directly into 725 and OP07 sockets with or without removal of external compensation or nulling components. Additionally, the OP27 may be fitted to unnulling 741-type sockets; however, if conventional 741 nulling circuitry is in use, it should be modified or removed to ensure correct OP27 operation. OP27 offset voltage may be nulled to zero (or another desired setting) using a potentiometer (see Offset Nulling Circuit).

The OP27 provides stable operation with load capacitances of up to 2000 pF and ± 10 V swings; larger capacitances should be decoupled with a 50 Ω resistor inside the feedback loop. The OP27 is unity-gain stable.

Thermoelectric voltages generated by dissimilar metals at the input terminal contacts can degrade the drift performance. Best operation will be obtained when both input contacts are maintained at the same temperature.

OFFSET VOLTAGE ADJUSTMENT

The input offset voltage of the OP27 is trimmed at wafer level. However, if further adjustment of V_{OS} is necessary, a 10 k Ω trim potentiometer can be used. TCV_{OS} is not degraded (see Offset Nulling Circuit). Other potentiometer values from 1 k Ω to 1 M Ω can be used with a slight degradation (0.1 $\mu V/^{\circ}C$ to 0.2 $\mu V/^{\circ}C$) of TCV_{OS} . Trimming to a value other than zero creates a drift of

approximately $(V_{OS}/300)$ $\mu V/^{\circ}C$. For example, the change in TCV_{OS} will be 0.33 $\mu V/^{\circ}C$ if V_{OS} is adjusted to 100 μV . The offset voltage adjustment range with a 10 k Ω potentiometer is ± 4 mV. If smaller adjustment range is required, the nulling sensitivity can be reduced by using a smaller pot in conjunction with fixed resistors. For example, the network below will have a ± 280 μV adjustment range.

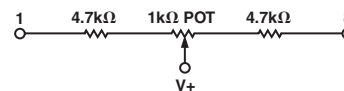

Figure 2.

NOISE MEASUREMENTS

To measure the 80 nV peak-to-peak noise specification of the OP27 in the 0.1 Hz to 10 Hz range, the following precautions must be observed:

1. The device must be warmed up for at least five minutes. As shown in the warm-up drift curve, the offset voltage typically changes 4 μV due to increasing chip temperature after power-up. In the 10-second measurement interval, these temperature-induced effects can exceed tens-of-nanovolts.
2. For similar reasons, the device has to be well-shielded from air currents. Shielding minimizes thermocouple effects.

OP27

3. Sudden motion in the vicinity of the device can also “feedthrough” to increase the observed noise.
4. The test time to measure 0.1 Hz to 10 Hz noise should not exceed 10 seconds. As shown in the noise-tester frequency response curve, the 0.1 Hz corner is defined by only one zero. The test time of 10 seconds acts as an additional zero to eliminate noise contributions from the frequency band below 0.1 Hz.
5. A noise-voltage-density test is recommended when measuring noise on a large number of units. A 10 Hz noise-voltage-density measurement will correlate well with a 0.1 Hz to 10 Hz peak-to-peak noise reading, since both results are determined by the white noise and the location of the 1/f corner frequency.

UNITY-GAIN BUFFER APPLICATIONS

When $R_f \leq 100 \Omega$ and the input is driven with a fast, large signal pulse ($>1 \text{ V}$), the output waveform will look as shown in the pulsed operation diagram (Figure 3).

During the fast feedthrough-like portion of the output, the input protection diodes effectively short the output to the input and a current, limited only by the output short-circuit protection, will be drawn by the signal generator. With $R_f \geq 500 \Omega$, the output is capable of handling the current requirements ($I_L \leq 20 \text{ mA}$ at 10 V); the amplifier will stay in its active mode and a smooth transition will occur.

When $R_f > 2 \text{ k}\Omega$, a pole will be created with R_f and the amplifier’s input capacitance (8 pF) that creates additional phase shift and reduces phase margin. A small capacitor (20 pF to 50 pF) in parallel with R_f will eliminate this problem.

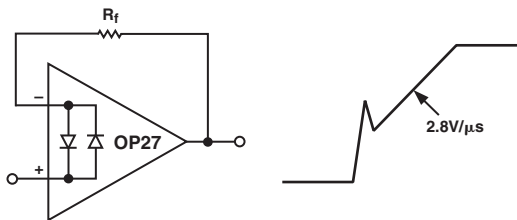

Figure 3. Pulsed Operation

COMMENTS ON NOISE

The OP27 is a very low-noise monolithic op amp. The outstanding input voltage noise characteristics of the OP27 are achieved mainly by operating the input stage at a high quiescent current. The input bias and offset currents, which would normally increase, are held to reasonable values by the input bias-current cancellation circuit. The OP27A/E has I_B and I_{OS} of only $\pm 40 \text{ nA}$ and 35 nA at 25°C respectively. This is particularly important when the input has a high source resistance. In addition, many audio amplifier designers prefer to use direct coupling. The high I_B , V_{OS} , and TCV_{OS} of previous designs have made direct coupling difficult, if not impossible, to use.

Voltage noise is inversely proportional to the square root of bias current, but current noise is proportional to the square root of bias current. The OP27’s noise advantage disappears when high source-resistors are used. Figures 4, 5, and 6 compare OP27’s observed total noise with the noise performance of other devices in different circuit applications.

$$\text{Total Noise} = \left[\begin{aligned} &(\text{Voltage Noise})^2 + \\ &(\text{Current Noise} \times R_S)^2 + \\ &(\text{Resistor Noise})^2 \end{aligned} \right]^{1/2}$$

Figure 4 shows noise versus source-resistance at 1000 Hz. The same plot applies to wideband noise. To use this plot, multiply the vertical scale by the square root of the bandwidth.

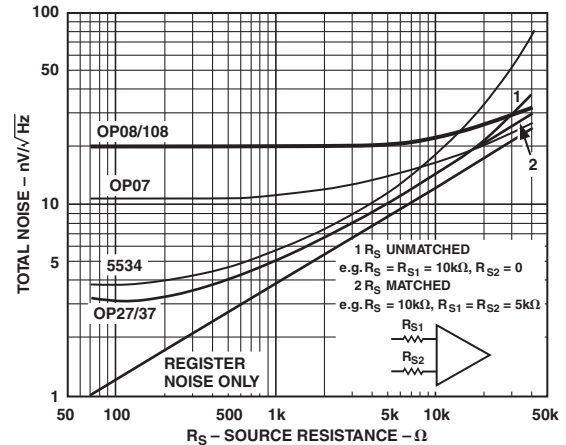

Figure 4. Noise vs. Source Resistance (Including Resistor Noise) at 1000 Hz

At $R_S < 1 \text{ k}\Omega$, the OP27’s low voltage noise is maintained. With $R_S < 1 \text{ k}\Omega$, total noise increases, but is dominated by the resistor noise rather than current or voltage noise. It is only beyond R_S of $20 \text{ k}\Omega$ that current noise starts to dominate. The argument can be made that current noise is not important for applications with low to moderate source resistances. The crossover between the OP27, OP07, and OP08 noise occurs in the $15 \text{ k}\Omega$ to $40 \text{ k}\Omega$ region.

Figure 5 shows the 0.1 Hz to 10 Hz peak-to-peak noise. Here the picture is less favorable; resistor noise is negligible and current noise becomes important because it is inversely proportional to the square root of frequency. The crossover with the OP07 occurs in the $3 \text{ k}\Omega$ to $5 \text{ k}\Omega$ range depending on whether balanced or unbalanced source resistors are used (at $3 \text{ k}\Omega$ the I_B and I_{OS} error also can be three times the V_{OS} spec.).

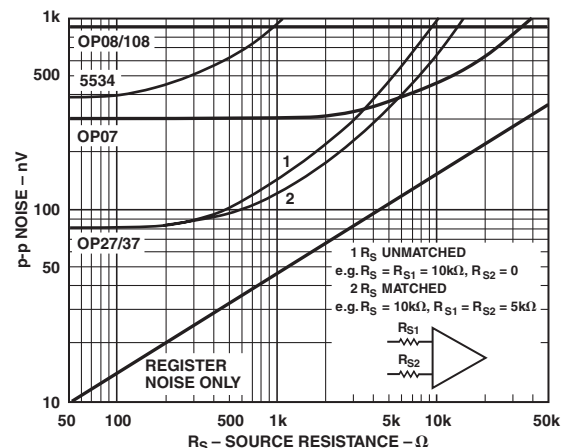

Figure 5. Peak-to-Peak Noise (0.1 Hz to 10 Hz) as Source Resistance (Includes Resistor Noise)

Therefore, for low-frequency applications, the OP07 is better than the OP27/OP37 when $R_S > 3 \text{ k}\Omega$. The only exception is when gain error is important. Figure 6 illustrates the 10 Hz noise. As expected, the results are between the previous two figures.

For reference, typical source resistances of some signal sources are listed in Table I.

Table I.

Device	Source Impedance	Comments
Strain Gauge	<500 Ω	Typically used in low-frequency applications.
Magnetic Tapehead	<1500 Ω	Low is very important to reduce self-magnetization problems when direct coupling is used. OP27 I_B can be neglected.
Magnetic Phonograph Cartridges	<1500 Ω	Similar need for low I_B in direct coupled applications. OP27 will not introduce any self-magnetization problem.
Linear Variable Differential Transformer	<1500 Ω	Used in rugged servo-feedback applications. Bandwidth of interest is 400 Hz to 5 kHz.

Open-Loop Gain

Frequency at	OP07	OP27	OP37
3 Hz	100 dB	124 dB	125 dB
10 Hz	100 dB	120 dB	125 dB
30 Hz	90 dB	110 dB	124 dB

For further information regarding noise calculations, see "Minimization of Noise in Op Amp Applications," Application Note AN-15.

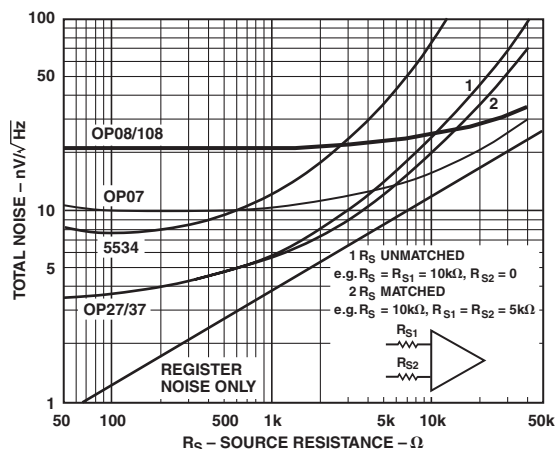

Figure 6. 10 Hz Noise vs. Source Resistance (Includes Resistor Noise)

AUDIO APPLICATIONS

The following applications information has been abstracted from a PMI article in the 12/20180 issue of Electronic Design magazine and updated.

Figure 7 is an example of a phono pre-amplifier circuit using the OP27 for A1; R1-R2-C1-C2 form a very accurate RIAA network with standard component values. The popular method to accomplish RIAA phono equalization is to employ frequency-dependent feedback around a high-quality gain block. Properly chosen, an RC network can provide the three necessary time constants of 3180, 318, and 75 μs .¹

For initial equalization accuracy and stability, precision metal film resistors and film capacitors of polystyrene or polypropylene are recommended since they have low voltage coefficients, dissipation factors, and dielectric absorption.⁴ (High-K ceramic capacitors should be avoided here, though low-K ceramics—such as NPO types, which have excellent dissipation factors and somewhat lower dielectric absorption—can be considered for small values.)

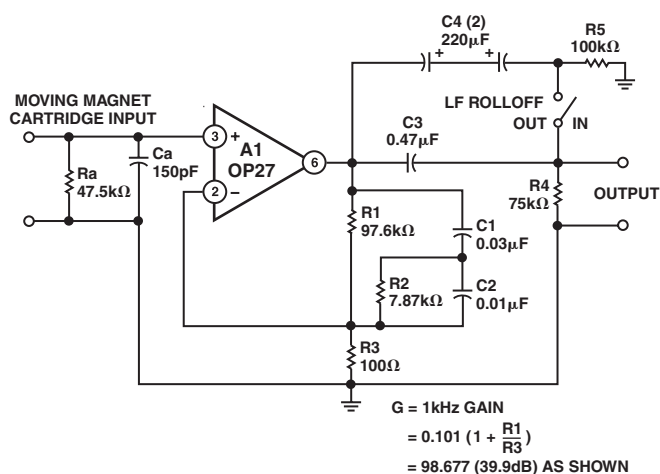

Figure 7.

The OP27 brings a $3.2 \text{ nV}/\sqrt{\text{Hz}}$ voltage noise and $0.45 \text{ pA}/\sqrt{\text{Hz}}$ current noise to this circuit. To minimize noise from other sources, R3 is set to a value of 100 Ω , which generates a voltage noise of $1.3 \text{ nV}/\sqrt{\text{Hz}}$. The noise increases the $3.2 \text{ nV}/\sqrt{\text{Hz}}$ of the amplifier by only 0.7 dB. With a 1 k Ω source, the circuit noise measures 63 dB below a 1 mV reference level, unweighted, in a 20 kHz noise bandwidth.

Gain (G) of the circuit at 1 kHz can be calculated by the expression:

$$G = 0.101 \left(1 + \frac{R1}{R3} \right)$$

For the values shown, the gain is just under 100 (or 40 dB). Lower gains can be accommodated by increasing R3, but gains higher than 40 dB will show more equalization errors because of the 8 MHz gain-bandwidth of the OP27.

This circuit is capable of very low distortion over its entire range, generally below 0.01% at levels up to 7 V rms. At 3 V output levels, it will produce less than 0.03% total harmonic distortion at frequencies up to 20 kHz.

Capacitor C3 and resistor R4 form a simple -6 dB-per-octave rumble filter, with a corner at 22 Hz. As an option, the switch-selected shunt capacitor C4, a nonpolarized electrolytic, bypasses the low-frequency rolloff. Placing the rumble filter's high-pass action after the preamp has the desirable result of discriminating

OP27

against the RIAA-amplified low-frequency noise components and pickup-produced low-frequency disturbances.

A preamplifier for NAB tape playback is similar to an RIAA phono preamp, though more gain is typically demanded, along with equalization requiring a heavy low-frequency boost. The circuit in Figure 7 can be readily modified for tape use, as shown by Figure 8.

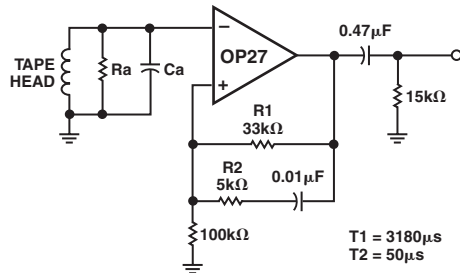

Figure 8.

While the tape-equalization requirement has a flat high-frequency gain above 3 kHz ($T_2 = 50 \mu s$), the amplifier need not be stabilized for unity gain. The decompensated OP37 provides a greater bandwidth and slew rate. For many applications, the idealized time constants shown may require trimming of R1 and R2 to optimize frequency response for nonideal tapehead performance and other factors.⁵

The network values of the configuration yield a 50 dB gain at 1 kHz, and the dc gain is greater than 70 dB. Thus, the worst-case output offset is just over 500 mV. A single 0.47 μF output capacitor can block this level without affecting the dynamic range.

The tapehead can be coupled directly to the amplifier input, since the worst-case bias current of 80 nA with a 400 mH, 100 μ inch head (such as the PRB2H7K) will not be troublesome.

One potential tapehead problem is presented by amplifier bias-current transients which can magnetize a head. The OP27 and OP37 are free of bias-current transients upon power-up or power-down. However, it is always advantageous to control the speed of power supply rise and fall, to eliminate transients.

In addition, the dc resistance of the head should be carefully controlled, and preferably below 1 k Ω . For this configuration, the bias-current-induced offset voltage can be greater than the 100pV maximum offset if the head resistance is not sufficiently controlled.

A simple, but effective, fixed-gain transformerless microphone preamp (Figure 9) amplifies differential signals from low impedance microphones by 50 dB, and has an input impedance of 2 k Ω . Because of the high working gain of the circuit, an OP37 helps to preserve bandwidth, which will be 110 kHz. As the OP37 is a decompensated device (minimum stable gain of 5), a dummy resistor, Rp, may be necessary, if the microphone is to be unplugged. Otherwise the 100% feedback from the open input may cause the amplifier to oscillate.

Common-mode input-noise rejection will depend upon the match of the bridge-resistor ratios. Either close-tolerance (0.1%) types should be used, or R4 should be trimmed for best CMRR. All resistors should be metal film types for best stability and low noise.

Noise performance of this circuit is limited more by the input resistors R1 and R2 than by the op amp, as R1 and R2 each generate a $4 \text{ nV}/\sqrt{\text{Hz}}$ noise, while the op amp generates a $3.2 \text{ nV}/\sqrt{\text{Hz}}$

noise. The rms sum of these predominant noise sources will be about $6 \text{ nV}/\sqrt{\text{Hz}}$, equivalent to 0.9 μV in a 20 kHz noise bandwidth, or nearly 61 dB below a 1 mV input signal. Measurements confirm this predicted performance.

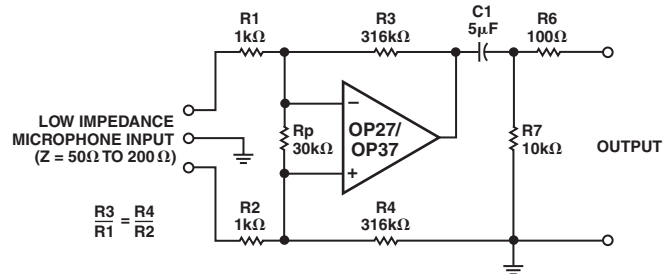

Figure 9.

For applications demanding appreciably lower noise, a high quality microphone transformer-coupled preamp (Figure 10) incorporates the internally compensated OP27. T1 is a JE-115K-E 150 Ω /15 k Ω transformer which provides an optimum source resistance for the OP27 device. The circuit has an overall gain of 40 dB, the product of the transformer's voltage setup and the op amp's voltage gain.

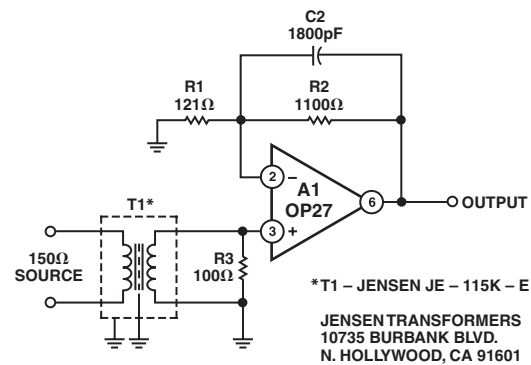

Figure 10.

Gain may be trimmed to other levels, if desired, by adjusting R2 or R1. Because of the low offset voltage of the OP27, the output offset of this circuit will be very low, 1.7 mV or less, for a 40 dB gain. The typical output blocking capacitor can be eliminated in such cases, but is desirable for higher gains to eliminate switching transients.

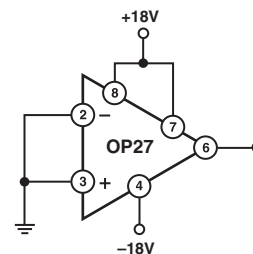

Figure 11. Burn-In Circuit

Capacitor C2 and resistor R2 form a 2 μs time constant in this circuit, as recommended for optimum transient response by the transformer manufacturer. With C2 in use, A1 must have unity-gain stability. For situations where the 2 μs time constant is not necessary, C2 can be deleted, allowing the faster OP37 to be employed.

Some comment on noise is appropriate to understand the capability of this circuit. A 150 Ω resistor and R1 and R2 gain resistors connected to a noiseless amplifier will generate 220 nV of noise in a 20 kHz bandwidth, or 73 dB below a 1 mV reference level. Any practical amplifier can only approach this noise level; it can never exceed it. With the OP27 and T1 specified, the additional noise degradation will be close to 3.6 dB (or -69.5 referenced to 1 mV).

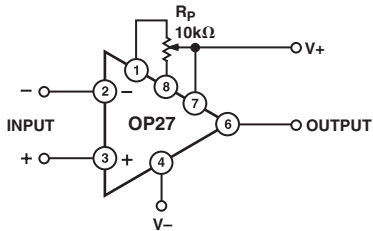

Figure 12. Offset Nulling Circuit

References

1. Lipshitz, S.R., "On RIAA Equalization Networks," JAES, Vol. 27, June 1979, p. 458-481.
2. Jung, W.G., *IC Op Amp Cookbook*, 2nd. Ed., H.W. Sams and Company, 1980.
3. Jung, W.G., *Audio IC Op Amp Applications*, 2nd. Ed., H.W. Sams and Company, 1978.
4. Jung, W.G., and Marsh, R.M., "Picking Capacitors," *Audio*, February and March, 1980.
5. Ojala, M., "Feedback-Generated Phase Nonlinearity in Audio Amplifiers," London AES Convention, March 1980, preprint 1976.
6. Stout, D.F., and Kautman, M., *Handbook of Operational Amplifier Circuit Design*, New York, McGraw-Hill, 1976.

OUTLINE DIMENSIONS

Dimensions shown in inches and (mm).

8-Lead PDIP Package (P-Suffix)

(N-8)

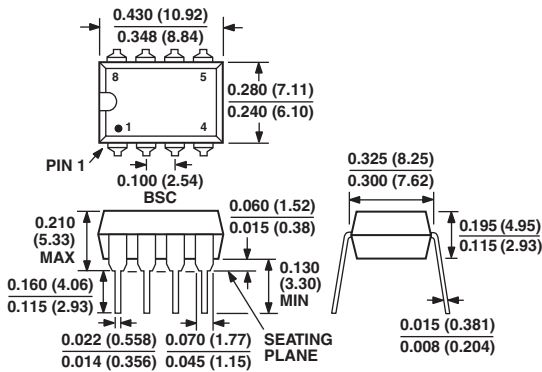

8-Lead SOIC Package (S-Suffix)

(R-8)

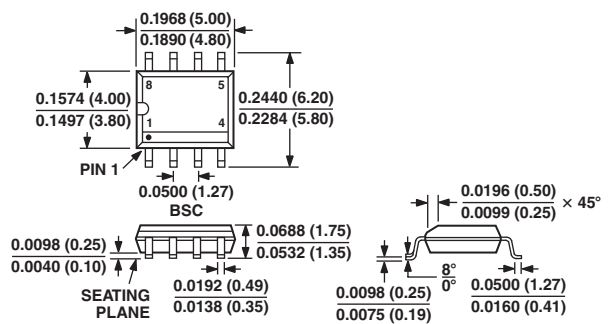

8-Lead CERDIP Package (Z-Suffix)

(Q-8)

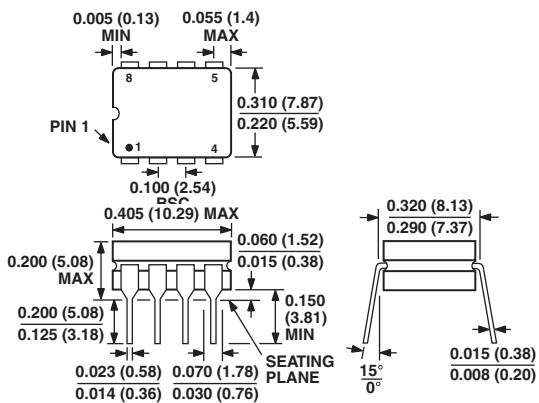

8-Pin (TO-99) Header Package (J-Suffix)

(H-8A)

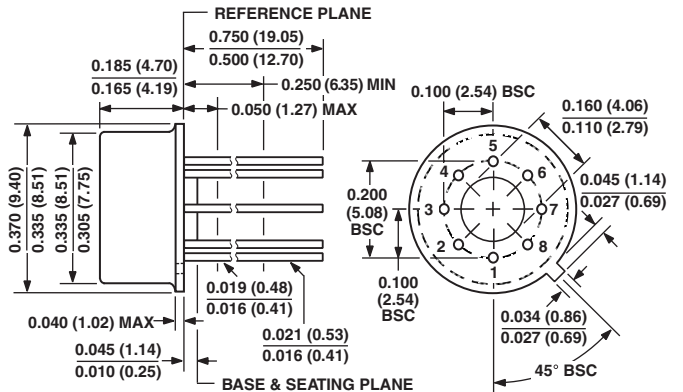

Revision History

Location	Page
9/01—Data Sheet changed from REV. 0 to REV. A.	
Edits to ORDERING INFORMATION	1
Edits to PIN CONNECTIONS	1
Edits to ABSOLUTE MAXIMUM RATINGS	2
Edits to PACKAGE TYPE	2
Edits to ELECTRICAL CHARACTERISTICS	2, 3
Edits to WAFER TEST LIMITS	4
Deleted TYPICAL ELECTRICAL CHARACTERISTICS	4
Edits to BURN-IN CIRCUIT figure	7
Edits to APPLICATION INFORMATION	8

C00317-0-1/02(A)

PRINTED IN U.S.A.