

## AD7895

### FEATURES

**Fast 12-Bit ADC with 3.8  $\mu$ s Conversion Time**  
**8-Pin Mini-DIP and SOIC**  
**Single 5 V Supply Operation**  
**High Speed, Easy-to-Use, Serial Interface**  
**On-Chip Track/Hold Amplifier**  
**Selection of Input Ranges**  
 $\pm 10$  V for AD7895-10  
 $\pm 2.5$  V for AD7895-3  
 0 V to +2.5 V for AD7895-2  
**High Input Impedance**  
**Low Power: 20 mW max**  
**14-Bit Pin Compatible Upgrade (AD7894)**

### GENERAL DESCRIPTION

The AD7895 is a fast 12-bit ADC that operates from a single +5 V supply and is housed in a small 8-pin mini-DIP and 8-pin SOIC. The part contains a 3.8  $\mu$ s successive approximation A/D converter, an on-chip track/hold amplifier, an on-chip clock and a high speed serial interface.

Output data from the AD7895 is provided via a high speed, serial interface port. This two-wire serial interface has a serial clock input and a serial data output with the external serial clock accessing the serial data from the part.

In addition to the traditional dc accuracy specifications such as linearity and full-scale and offset errors, the AD7895 is specified for dynamic performance parameters, including harmonic distortion and signal-to-noise ratio.

The part accepts an analog input range of  $\pm 10$  V (AD7895-10),  $\pm 2.5$  V (AD7895-3), 0 V to 2.5 V (AD7895-2) and operates from a single +5 V supply, consuming only 20 mW max.

The AD7895 features a high sampling rate mode and, for low power applications, a proprietary automatic power-down mode where the part automatically goes into power down once conversion is complete and "wakes up" before the next conversion cycle.

The part is available in a small, 8-pin, 0.3" wide, plastic dual-in-line package (mini-DIP) and in an 8-pin, small outline IC (SOIC).

### FUNCTIONAL BLOCK DIAGRAM

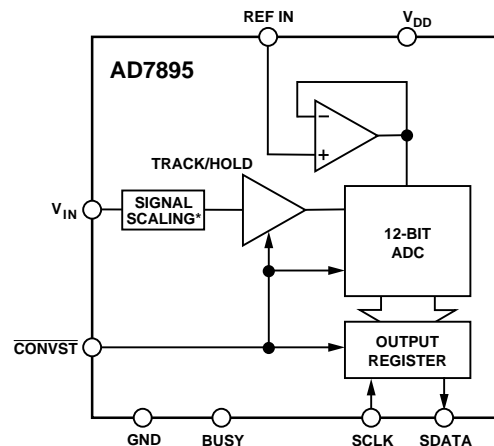

\*AD7895-10, AD7895-3

### PRODUCT HIGHLIGHTS

- Fast, 12-Bit ADC in 8-Pin Package**  
 The AD7895 contains a 3.8  $\mu$ s ADC, a track/hold amplifier, control logic and a high speed serial interface, all in an 8-pin package. This offers considerable space saving over alternative solutions.
- Low Power, Single Supply Operation**  
 The AD7895 operates from a single +5 V supply and consumes only 20 mW. The automatic power-down mode, where the part goes into power-down once conversion is complete and "wakes up" before the next conversion cycle, makes the AD7895 ideal for battery-powered or portable applications.
- High Speed Serial Interface**  
 The part provides high speed serial data and serial clock lines allowing for an easy, two-wire serial interface arrangement.

### REV. 0

Information furnished by Analog Devices is believed to be accurate and reliable. However, no responsibility is assumed by Analog Devices for its use, nor for any infringements of patents or other rights of third parties which may result from its use. No license is granted by implication or otherwise under any patent or patent rights of Analog Devices.

# AD7895—SPECIFICATIONS

( $V_{DD} = +5\text{ V}$ ,  $GND = 0\text{ V}$ ,  $REF\ IN = +2.5\text{ V}$ .)

All specifications  $T_{MIN}$  to  $T_{MAX}$  unless otherwise noted)

| Parameter                                                          | A Versions <sup>1</sup>   | B Versions  | Units       | Test Conditions/Comments                                                                |
|--------------------------------------------------------------------|---------------------------|-------------|-------------|-----------------------------------------------------------------------------------------|
| <b>DYNAMIC PERFORMANCE<sup>2</sup></b>                             |                           |             |             |                                                                                         |
| Signal to (Noise + Distortion) Ratio <sup>3</sup><br>@ +25°C       | 70                        | 70          | dB min      | $f_{IN} = 50\text{ kHz}$ Sine Wave, $f_{SAMPLE} = 200\text{ kHz}$                       |
| $T_{MIN}$ to $T_{MAX}$                                             | 70                        | 70          | dB min      |                                                                                         |
| Total Harmonic Distortion (THD) <sup>3</sup>                       | -78                       | -78         | dB max      | $f_{IN} = 50\text{ kHz}$ Sine Wave, $f_{SAMPLE} = 200\text{ kHz}$ ,<br>Typically -87 dB |
| Peak Harmonic or Spurious Noise <sup>3</sup>                       | -89                       | -89         | dB typ      | $f_{IN} = 50\text{ kHz}$ Sine Wave, $f_{SAMPLE} = 200\text{ kHz}$                       |
| Intermodulation Distortion (IMD) <sup>3</sup>                      |                           |             |             | $f_a = 9\text{ kHz}$ , $f_b = 9.5\text{ kHz}$ , $f_{SAMPLE} = 200\text{ kHz}$           |
| 2nd Order Terms                                                    | -87                       | -87         | dB typ      |                                                                                         |
| 3rd Order Terms                                                    | -87                       | -87         | dB typ      |                                                                                         |
| <b>DC ACCURACY</b>                                                 |                           |             |             |                                                                                         |
| Resolution                                                         | 12                        | 12          | Bits        |                                                                                         |
| Minimum Resolution for which<br>No Missing Codes are Guaranteed    | 12                        | 12          | Bits        |                                                                                         |
| Relative Accuracy <sup>3</sup>                                     | ±1                        | ±1          | LSB max     | Typically 0.4 LSB                                                                       |
| Differential Nonlinearity <sup>3</sup>                             | ±1                        | ±1          | LSB max     |                                                                                         |
| Positive Full-Scale Error <sup>3</sup>                             | ±3                        | ±2          | LSB max     |                                                                                         |
| AD7895-2<br>Unipolar Offset Error                                  | ±3                        | ±2          | LSB max     |                                                                                         |
| AD7895-10, AD7895-3 Only<br>Negative Full-Scale Error <sup>3</sup> | ±3                        | ±2          | LSB max     |                                                                                         |
| Bipolar Zero Error                                                 | ±4                        | ±3          | LSB max     |                                                                                         |
| <b>ANALOG INPUT</b>                                                |                           |             |             |                                                                                         |
| AD7895-10                                                          |                           |             |             |                                                                                         |
| Input Voltage Range                                                | ±10                       | ±10         | Volts       |                                                                                         |
| Input Resistance                                                   | 24                        | 24          | kΩ min      |                                                                                         |
| AD7895-3                                                           |                           |             |             |                                                                                         |
| Input Voltage Range                                                | ±2.5                      | ±2.5        | Volts       |                                                                                         |
| Input Resistance                                                   | 9                         | 9           | kΩ min      |                                                                                         |
| AD7895-2                                                           |                           |             |             |                                                                                         |
| Input Voltage Range                                                | 0 to +2.5                 | 0 to +2.5   | Volts       |                                                                                         |
| Input Current                                                      | 500                       | 500         | nA max      |                                                                                         |
| <b>REFERENCE INPUT</b>                                             |                           |             |             |                                                                                         |
| REF IN Input Voltage Range                                         | 2.375/2.625               | 2.375/2.625 | V min/V max | 2.5 V ± 5%                                                                              |
| Input Current                                                      | 1                         | 1           | μA max      |                                                                                         |
| Input Capacitance <sup>3</sup>                                     | 10                        | 10          | pF max      |                                                                                         |
| <b>LOGIC INPUTS</b>                                                |                           |             |             |                                                                                         |
| Input High Voltage, $V_{INH}$                                      | 2.4                       | 2.4         | V min       | $V_{DD} = 5\text{ V} \pm 5\%$                                                           |
| Input Low Voltage, $V_{INL}$                                       | 0.8                       | 0.8         | V max       | $V_{DD} = 5\text{ V} \pm 5\%$                                                           |
| Input Current, $I_{IN}$                                            | ±10                       | ±10         | μA max      | $V_{IN} = 0\text{ V}$ to $V_{DD}$                                                       |
| Input Capacitance, $C_{IN}$ <sup>4</sup>                           | 10                        | 10          | pF ax       |                                                                                         |
| <b>LOGIC OUTPUTS</b>                                               |                           |             |             |                                                                                         |
| Output High Voltage, $V_{OH}$                                      | 4.0                       | 4.0         | V min       | $I_{SOURCE} = 200\text{ μA}$                                                            |
| Output Low Voltage, $V_{OL}$                                       | 0.4                       | 0.4         | V max       | $I_{SINK} = 1.6\text{ mA}$                                                              |
| Output Coding                                                      |                           |             |             |                                                                                         |
| AD7895-10, AD7895-3                                                | 2s Complement             |             |             |                                                                                         |
| AD7895-2                                                           | Straight (Natural) Binary |             |             |                                                                                         |
| <b>CONVERSION RATE</b>                                             |                           |             |             |                                                                                         |
| Conversion Time                                                    |                           |             |             |                                                                                         |
| Mode 1 Operation                                                   | 3.8                       | 3.8         | μs max      |                                                                                         |
| Mode 2 Operation <sup>5</sup>                                      | 9.8                       | 9.8         | μs max      |                                                                                         |
| Track/Hold Acquisition Time <sup>3</sup>                           | 0.5                       | 0.5         | μs max      |                                                                                         |
| <b>POWER REQUIREMENTS</b>                                          |                           |             |             |                                                                                         |
| $V_{DD}$                                                           | +5                        | +5          | V nom       | ±5% for Specified Performance                                                           |
| $I_{DD}$                                                           | 4                         | 4           | mA max      | Digital Inputs @ $V_{DD}$ , $V_{DD} = 5\text{ V} \pm 5\%$                               |
| Power Dissipation                                                  | 20                        | 20          | mW max      | Typically 16 mW                                                                         |
| Power-Down Mode                                                    |                           |             |             |                                                                                         |
| $I_{DD}$ @ +25°C                                                   | 5                         | 5           | μA max      | Digital Inputs @ GND, $V_{DD} = 5\text{ V} \pm 5\%$                                     |
| $T_{MIN}$ to $T_{MAX}$                                             | 10                        | 10          | μA max      | Digital Inputs @ GND, $V_{DD} = 5\text{ V} \pm 5\%$                                     |
| Power Dissipation @ +25°C                                          | 25                        | 25          | μW max      |                                                                                         |

## NOTES

<sup>1</sup>Temperature ranges are as follows: A, B Versions: -40°C to +85°C.

<sup>2</sup>Applies to Mode 1 operation. See section on "Operating Modes."

<sup>3</sup>See Terminology.

<sup>4</sup>Sample tested @ +25°C to ensure compliance.

<sup>5</sup>This 9.8 μs includes the "wake-up" time from standby. This "wake-up" time is timed from the rising edge of  $\overline{CONVST}$ , whereas conversion is timed from the falling edge of  $\overline{CONVST}$ , for narrow  $\overline{CONVST}$  pulse width the conversion time is effectively the "wake-up" time plus conversion time hence 9.8 μs. This can be seen from Figure 3. Note that if the  $\overline{CONVST}$  pulse width is greater than 6 μs then the effective conversion time will increase beyond 9.8 μs.

Specifications subject to change without notice.

## TIMING CHARACTERISTICS<sup>1, 2</sup> ( $V_{DD} = +5\text{ V}$ , $GND = 0\text{ V}$ , $REF\ IN = +2.5\text{ V}$ )

| Parameter | A, B Versions   | Units  | Test Conditions/Comments                                                   |
|-----------|-----------------|--------|----------------------------------------------------------------------------|
| $t_1$     | 40              | ns min | $\overline{CONVST}$ Pulse Width                                            |
| $t_2$     | 35 <sup>2</sup> | ns min | SCLK High Pulse Width                                                      |
| $t_3$     | 35 <sup>2</sup> | ns min | SCLK Low Pulse Width                                                       |
| $t_4$     | 60 <sup>3</sup> | ns max | Data Access Time after Falling Edge of SCLK, $V_{DD} = 5\text{ V} \pm 5\%$ |
| $t_5$     | 10              | ns min | Data Hold Time after Falling Edge of SCLK                                  |
| $t_6$     | 50 <sup>4</sup> | ns max | Bus Relinquish Time after Falling Edge of SCLK                             |

### NOTES

<sup>1</sup> Sample tested at +25°C to ensure compliance. All input signals are measured with  $t_r = t_f = 1\text{ ns}$  (10% to 90% of +5 V) and timed from a voltage level of +1.4 V.

<sup>2</sup> The SCLK maximum frequency is 15 MHz. Care must be taken when interfacing to account for the data access time,  $t_4$ , and the setup time required for the user's processor. These two times will determine the maximum SCLK frequency that the user's system can operate with. See "Serial Interface" section for more information.

<sup>3</sup> Measured with the load circuit of Figure 1 and defined as the time required for an output to cross 0.8 V or 2.0 V.

<sup>4</sup> Derived from the measured time taken by the data outputs to change 0.5 V when loaded with the circuit of Figure 1. The measured number is then extrapolated back to remove the effects of charging or discharging the 50 pF capacitor. This means that the time,  $t_6$ , quoted in the timing characteristics is the true bus relinquish time of the part and, as such, is independent of external bus loading capacitances.

### ABSOLUTE MAXIMUM RATINGS\*

( $T_A = +25^\circ\text{C}$  unless otherwise noted)

$V_{DD}$  to GND . . . . . -0.3 V to +7 V

Analog Input Voltage to GND

AD7895-10 . . . . .  $\pm 17\text{ V}$

AD7895-2, AD7895-3 . . . . . -5 V, +10 V

Reference Input Voltage to GND . . . . -0.3 V to  $V_{DD} + 0.3\text{ V}$

Digital Input Voltage to GND . . . . . -0.3 V to  $V_{DD} + 0.3\text{ V}$

Digital Output Voltage to GND . . . . . -0.3 V to  $V_{DD} + 0.3\text{ V}$

Operating Temperature Range

Commercial (A, B Versions) . . . . . -40°C to +85°C

Storage Temperature Range . . . . . -65°C to +150°C

Junction Temperature . . . . . +150°C

Plastic DIP Package, Power Dissipation . . . . . 450 mW

$\theta_{JA}$  Thermal Impedance . . . . . 130°C/W

Lead Temperature (Soldering, 10 sec) . . . . . +260°C

SOIC Package, Power Dissipation . . . . . 450 mW

$\theta_{JA}$  Thermal Impedance . . . . . 170°C/W

Lead Temperature, Soldering

Vapor Phase (60 sec) . . . . . +215°C

Infrared (15 sec) . . . . . +220°C

\*Stresses above those listed under "Absolute Maximum Ratings" may cause permanent damage to the device. This is a stress rating only and functional operation of the device at these or any other conditions above those listed in the operational sections of this specification is not implied. Exposure to absolute maximum rating conditions for extended periods may affect device reliability.

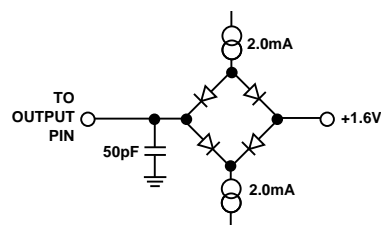

Figure 1. Load Circuit for Access Time and Bus Relinquish Time

### ORDERING GUIDE

| Model       | Temperature Range | Linearity Error (LSB) | SNR (dB) | Package Option* |
|-------------|-------------------|-----------------------|----------|-----------------|
| AD7895AN-2  | -40°C to +85°C    | $\pm 1$ LSB           | 70 dB    | N-8             |
| AD7895AR-2  | -40°C to +85°C    | $\pm 1$ LSB           | 70 dB    | SO-8            |
| AD7895BR-2  | -40°C to +85°C    | $\pm 1$ LSB           | 70 dB    | SO-8            |
| AD7895AN-10 | -40°C to +85°C    | $\pm 1$ LSB           | 70 dB    | N-8             |
| AD7895AR-10 | -40°C to +85°C    | $\pm 1$ LSB           | 70 dB    | SO-8            |
| AD7895BR-10 | -40°C to +85°C    | $\pm 1$ LSB           | 70 dB    | SO-8            |
| AD7895AN-3  | -40°C to +125°C   | $\pm 1$ LSB           | 70 dB    | N-8             |
| AD7895AR-3  | -40°C to +85°C    | $\pm 1$ LSB           | 70 dB    | SO-8            |

\*N = Plastic DIP, SO = SOIC.

### CAUTION

ESD (electrostatic discharge) sensitive device. Electrostatic charges as high as 4000 V readily accumulate on the human body and test equipment and can discharge without detection. Although the AD7895 features proprietary ESD protection circuitry, permanent damage may occur on devices subjected to high energy electrostatic discharges. Therefore, proper ESD precautions are recommended to avoid performance degradation or loss of functionality.



# AD7895

## PIN FUNCTION DESCRIPTION

| Pin No. | Pin Mnemonic               | Description                                                                                                                                                                                                                                                                                                                                                                                                                                                                                                                                                                                                                                                                       |
|---------|----------------------------|-----------------------------------------------------------------------------------------------------------------------------------------------------------------------------------------------------------------------------------------------------------------------------------------------------------------------------------------------------------------------------------------------------------------------------------------------------------------------------------------------------------------------------------------------------------------------------------------------------------------------------------------------------------------------------------|
| 1       | REF IN                     | Voltage Reference Input. An external reference source should be connected to this pin to provide the reference voltage for the AD7895's conversion process. The REF IN input is buffered on chip. The nominal reference voltage for correct operation of the AD7895 is +2.5 V.                                                                                                                                                                                                                                                                                                                                                                                                    |
| 2       | V <sub>IN</sub>            | Analog Input Channel. The analog input range is ±10 V (AD7895-10), ±2.5 V (AD7895-3) and 0 V to +2.5 V (AD7895-2).                                                                                                                                                                                                                                                                                                                                                                                                                                                                                                                                                                |
| 3       | GND                        | Analog Ground. Ground reference for track/hold, comparator, digital circuitry and DAC.                                                                                                                                                                                                                                                                                                                                                                                                                                                                                                                                                                                            |
| 4       | SCLK                       | Serial Clock Input. An external serial clock is applied to this input to obtain serial data from the AD7895. A new serial data bit is clocked out on the falling edge of this serial clock. Data is guaranteed valid for 10 ns after this falling edge so that data can be accepted on the falling edge when a fast serial clock is used. The serial clock input should be taken low at the end of the serial data transmission.                                                                                                                                                                                                                                                  |
| 5       | SDATA                      | Serial Data Output. Serial data from the AD7895 is provided at this output. The serial data is clocked out by the falling edge of SCLK, but the data can also be read on the falling edge of SCLK. This is possible because data bit N is valid for a specified time after the falling edge of SCLK (data hold time) (see Figure 4). Sixteen bits of serial data are provided with four leading zeros followed by the 12 bits of conversion data. On the sixteenth falling edge of SCLK, the SDATA line is held for the data hold time and then is disabled (three-stated). Output data coding is 2s complement for the AD7895-10, AD7895-3 and straight binary for the AD7895-2. |
| 6       | BUSY                       | The BUSY pin is used to indicate when the part is doing a conversion. The BUSY pin will go high on the falling edge of $\overline{\text{CONVST}}$ and will return low when the conversion is complete.                                                                                                                                                                                                                                                                                                                                                                                                                                                                            |
| 7       | $\overline{\text{CONVST}}$ | Convert Start. Edge-triggered logic input. On the falling edge of this input, the track/hold goes into its hold mode, and conversion is initiated. If $\overline{\text{CONVST}}$ is low at the end of conversion, the part goes into power-down mode. In this case, the rising edge of $\overline{\text{CONVST}}$ "wakes up" the part.                                                                                                                                                                                                                                                                                                                                            |
| 8       | V <sub>DD</sub>            | Positive supply voltage, +5 V ± 5%.                                                                                                                                                                                                                                                                                                                                                                                                                                                                                                                                                                                                                                               |

## PIN CONFIGURATION DIP and SOIC

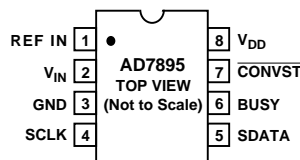

## TERMINOLOGY

### Signal to (Noise + Distortion) Ratio

This is the measured ratio of signal to (noise + distortion) at the output of the A/D converter. The signal is the rms amplitude of the fundamental. Noise is the rms sum of all nonfundamental signals up to half the sampling frequency ( $f_s/2$ ), excluding dc. The ratio is dependent upon the number of quantization levels in the digitization process; the more levels, the smaller the quantization noise. The theoretical signal to (noise + distortion) ratio for an ideal N-bit converter with a sine wave input is given by:

$$\text{Signal to (Noise + Distortion)} = (6.02N + 1.76) \text{ dB}$$

Thus for a 12-bit converter, this is 74 dB.

### Total Harmonic Distortion

Total harmonic distortion (THD) is the ratio of the rms sum of harmonics to the fundamental. For the AD7895, it is defined as:

$$\text{THD (dB)} = 20 \log \frac{\sqrt{V_2^2 + V_3^2 + V_4^2 + V_5^2 + V_6^2}}{V_1}$$

where  $V_1$  is the rms amplitude of the fundamental, and  $V_2$ ,  $V_3$ ,  $V_4$ ,  $V_5$  and  $V_6$  are the rms amplitudes of the second through the sixth harmonics.

### Peak Harmonic or Spurious Noise

Peak harmonic or spurious noise is defined as the ratio of the rms value of the next largest component in the ADC output spectrum (up to  $f_s/2$  and excluding dc) to the rms value of the fundamental. Normally, the value of this specification is determined by the largest harmonic in the spectrum, but for parts where the harmonics are buried in the noise floor, it will be a noise peak.

### Intermodulation Distortion

With inputs consisting of sine waves at two frequencies,  $f_a$  and  $f_b$ , any active device with nonlinearities will create distortion products at sum and difference frequencies of  $m f_a \pm n f_b$  where  $m, n = 0, 1, 2, 3$ , etc. Intermodulation terms are those for which neither  $m$  or  $n$  are equal to zero. For example, the second order terms include  $(f_a + f_b)$  and  $(f_a - f_b)$ , while the third order terms include  $(2 f_a + f_b)$ ,  $(2 f_a - f_b)$ ,  $(f_a + 2 f_b)$  and  $(f_a - 2 f_b)$ .

The AD7895 is tested using the CCIF standard where two input frequencies near the top end of the input bandwidth are used. In this case, the second and third order terms are of different significance. The second order terms are usually distanced in frequency from the original sine waves, while the third order terms are usually at a frequency close to the input frequencies. As a result, the second and third order terms are specified separately. The calculation of the intermodulation distortion is as per the THD specification where it is the ratio of the rms sum of the individual distortion products to the rms amplitude of the fundamental expressed in dBs.

### Relative Accuracy

Relative accuracy or endpoint nonlinearity is the maximum deviation from a straight line passing through the endpoints of the ADC transfer function.

### Differential Nonlinearity

This is the difference between the measured and the ideal 1 LSB change between any two adjacent codes in the ADC.

### Positive Full-Scale Error (AD7895-10)

This is the deviation of the last code transition (01 . . . 110 to 01 . . . 111) from the ideal ( $4 \times V_{REF} - 1 \text{ LSB}$ ) after the Bipolar Zero Error has been adjusted out.

### Positive Full-Scale Error (AD7895-3)

This is the deviation of the last code transition (01 . . . 110 to 01 . . . 111) from the ideal ( $V_{REF} - 1 \text{ LSB}$ ) after the Bipolar Zero Error has been adjusted out.

### Positive Full-Scale Error (AD7895-2)

This is the deviation of the last code transition (11 . . . 110 to 11 . . . 111) from the ideal ( $V_{REF} - 1 \text{ LSB}$ ) after the Unipolar Offset Error has been adjusted out.

### Bipolar Zero Error (AD7895-10, AD7895-3)

This is the deviation of the midscale transition (all 0s to all 1s) from the ideal 0 V (GND).

### Unipolar Offset Error (AD7895-2)

This is the deviation of the first code transition (00 . . . 000 to 00 . . . 001) from the ideal 1 LSB.

### Negative Full-Scale Error (AD7895-10)

This is the deviation of the first code transition (10 . . . 000 to 10 . . . 001) from the ideal ( $-4 \times V_{REF} + 1 \text{ LSB}$ ) after Bipolar Zero Error has been adjusted out.

### Negative Full-Scale Error (AD7895-3)

This is the deviation of the first code transition (10 . . . 000 to 10 . . . 001) from the ideal ( $-V_{REF} + 1 \text{ LSB}$ ) after Bipolar Zero Error has been adjusted out.

### Track/Hold Acquisition Time

Track/Hold acquisition time is the time required for the output of the track/hold amplifier to reach its final value, within  $\pm 1/2 \text{ LSB}$ , after the end of conversion (the point at which the track/hold returns to track mode). It also applies to situations where there is a step input change on the input voltage applied to the  $V_{IN}$  input of the AD7895. This means that the user must wait for the duration of the track/hold acquisition time after the end of conversion or after a step input change to  $V_{IN}$  before starting another conversion to ensure that the part operates to specification.

# AD7895

## CONVERTER DETAILS

The AD7895 is a fast, 12-bit single supply A/D converter. It provides the user with signal scaling, track/hold, A/D converter and serial interface logic functions on a single chip. The A/D converter section of the AD7895 consists of a conventional successive-approximation converter based around an R-2R ladder structure. The signal scaling on the AD7895-10 and AD7895-3 allows the part to handle  $\pm 10$  V and  $\pm 2.5$  V input signals, respectively, while operating from a single +5 V supply. The AD7895-2 accepts an analog input range of 0 V to +2.5 V. The part requires an external +2.5 V reference. The reference input to the part is buffered on-chip. The AD7895 has two operating modes, the high sampling mode and the auto sleep mode, where the part automatically goes into sleep after the end of conversion. These modes are discussed in more detail in the "Timing and Control" section.

A major advantage of the AD7895 is that it provides all of the above functions in an 8-pin package, either 8-pin mini-DIP or SOIC. This offers the user considerable spacing saving advantages over alternative solutions. The AD7895 consumes only 20 mW maximum, making it ideal for battery-powered applications.

Conversion is initiated on the AD7895 by pulsing the  $\overline{\text{CONVST}}$  input. On the falling edge of  $\overline{\text{CONVST}}$ , the on-chip track/hold goes from track to hold mode, and the conversion sequence is started. The conversion clock for the part is generated internally using a laser-trimmed clock oscillator circuit. Conversion time for the AD7895 is 3.8  $\mu\text{s}$  in the high sampling mode (9.8  $\mu\text{s}$  for the auto sleep mode), and the track/hold acquisition time is 0.3  $\mu\text{s}$ . To obtain optimum performance from the part, the read operation should not occur during the conversion or during 300 ns prior to the next conversion. This allows the part to operate at throughput rates up to 192 kHz and achieve data sheet specifications.

## CIRCUIT DESCRIPTION

### Analog Input Section

The AD7895 is offered as three part types: the AD7895-10, which handles a  $\pm 10$  V input voltage range; the AD7895-3, which handles input voltage range  $\pm 2.5$  V; and the AD7895-2, which handles a 0 V to +2.5 V input voltage range.

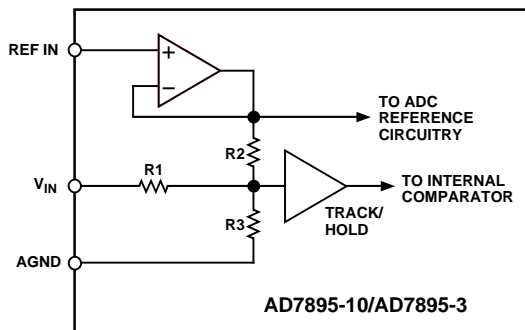

Figure 2. AD7895-10/AD7895-3 Analog Input Structure

Figure 2 shows the analog input section for the AD7895-10 and AD7895-3. The analog input range of the AD7895-10 is  $\pm 10$  V into an input resistance of typically 33 k $\Omega$ . The analog input range of the AD7895-3 is  $\pm 2.5$  V into an input resistance of typically 12 k $\Omega$ . This input is benign with no dynamic charging currents, as the resistor stage is followed by a high input imped-

ance stage of the track/hold amplifier. For the AD7895-10,  $R1 = 30$  k $\Omega$ ,  $R2 = 7.5$  k $\Omega$  and  $R3 = 10$  k $\Omega$ . For the AD7895-3,  $R1 = R2 = 6.5$  k $\Omega$  and  $R3$  is open circuit.

For the AD7895-10 and AD7895-3, the designed code transitions occur on successive integer LSB values (i.e., 1 LSB, 2 LSBs, 3 LSBs . . .). Output coding is 2s complement binary with 1 LSB =  $\text{FS}/4096$ . The ideal input/output transfer function for the AD7895-10 and AD7895-3 is shown in Table I.

Table I. Ideal Input/Output Code Table for the AD7895-10/-3 Digital Output

| Analog Input <sup>1</sup>   | Code Transition                |
|-----------------------------|--------------------------------|
| +FSR/2 – 1 LSB <sup>2</sup> | 011 . . . 110 to 011 . . . 111 |
| +FSR/2 – 2 LSBs             | 011 . . . 101 to 011 . . . 110 |
| +FSR/2 – 3 LSBs             | 011 . . . 100 to 011 . . . 101 |
| GND + 1 LSB                 | 000 . . . 000 to 000 . . . 001 |
| GND                         | 111 . . . 111 to 000 . . . 000 |
| GND – 1 LSB                 | 111 . . . 110 to 111 . . . 111 |
| –FSR/2 + 3 LSBs             | 100 . . . 010 to 100 . . . 011 |
| –FSR/2 + 2 LSBs             | 100 . . . 001 to 100 . . . 010 |
| –FSR/2 + 1 LSB              | 100 . . . 000 to 100 . . . 001 |

### NOTES

<sup>1</sup>FSR is full-scale range = 20 V (AD7895-10) and = 5 V (AD7895-3) with  $\text{REF IN} = +2.5$  V.

<sup>2</sup>1 LSB =  $\text{FSR}/4096 = 4.883$  mV (AD7895-10) and 1.22 mV (AD7895-3) with  $\text{REF IN} = +2.5$  V.

The analog input section for the AD7895-2 contains no biasing resistors, and the  $V_{\text{IN}}$  pin drives the input to the track/hold amplifier directly. The analog input range is 0 V to +2.5 V into a high impedance stage with an input current of less than 500 nA. This input is benign with no dynamic charging currents. Once again, the designed code transitions occur on successive integer LSB values. Output coding is straight (natural) binary with 1 LSB =  $\text{FS}/4096 = 2.5$  V/4096 = 0.61 mV. Table II shows the ideal input/output transfer function for the AD7895-2.

Table II. Ideal Input/Output Code Table for AD7895-2

| Analog Input <sup>1</sup> | Digital Output Code Transition |
|---------------------------|--------------------------------|
| +FSR – 1 LSB <sup>2</sup> | 111 . . . 110 to 111 . . . 111 |
| +FSR – 2 LSB              | 111 . . . 101 to 111 . . . 110 |
| +FSR – 3 LSB              | 111 . . . 100 to 111 . . . 101 |
| GND + 3 LSB               | 000 . . . 010 to 000 . . . 011 |
| GND + 2 LSB               | 000 . . . 001 to 000 . . . 010 |
| GND + 1 LSB               | 000 . . . 000 to 000 . . . 001 |

### NOTES

<sup>1</sup>FSR is full-scale range and is 2.5 V for AD7895-2 with  $V_{\text{REF}} = +2.5$  V.

<sup>2</sup>1 LSB =  $\text{FSR}/4096$  and is 0.61 mV for AD7895-2 with  $V_{\text{REF}} = +2.5$  V.

### Track/Hold Section

The track/hold amplifier on the analog input of the AD7895 allows the ADC to accurately convert an input sine wave of full-scale amplitude to 12-bit accuracy. The input bandwidth of the track/hold is greater than the Nyquist rate of the ADC even when the ADC is operated at its maximum throughput rate of 192 kHz (i.e., the track/hold can handle input frequencies in excess of 100 kHz).

The track/hold amplifier acquires an input signal to 12-bit accuracy in less than  $0.3\ \mu\text{s}$ . The operation of the track/hold is essentially transparent to the user. With the high sampling operating mode, the track/hold amplifier goes from its tracking mode to its hold mode at the start of conversion (i.e. the falling edge of  $\overline{\text{CONVST}}$ ). The aperture time for the track/hold (i.e. the delay time between the external  $\overline{\text{CONVST}}$  signal and the track/hold actually going into hold) is typically  $15\ \text{ns}$ . At the end of conversion (on the falling edge of  $\overline{\text{BUSY}}$ ), the part returns to its tracking mode. The acquisition time of the track/hold amplifier begins at this point. For the auto shut down mode, the rising edge of  $\overline{\text{CONVST}}$  wakes up the part and the track, and hold amplifier goes from its tracking mode to its hold mode  $6\ \mu\text{s}$  after the rising edge of  $\overline{\text{CONVST}}$  (provided that the  $\overline{\text{CONVST}}$  high time is less than  $6\ \mu\text{s}$ ). Once again, the part returns to its tracking mode at the end of conversion when the  $\overline{\text{BUSY}}$  signal goes low.

### Reference Input

The reference input to the AD7895 is buffered on-chip with a maximum reference input current of  $1\ \mu\text{A}$ . The part is specified with a  $+2.5\ \text{V}$  reference input voltage. Errors in the reference source will result in gain errors in the AD7895's transfer function and will add to the specified full-scale errors on the part. Suitable reference sources for the AD7895 include the AD780 and AD680 precision  $+2.5\ \text{V}$  references.

### Timing and Control Section

Figure 3 shows the timing and control sequence required to obtain optimum performance from the AD7895. In the sequence shown, conversion is initiated on the falling edge of  $\overline{\text{CONVST}}$ , and new data from this conversion is available in the output register of the AD7895  $3.8\ \mu\text{s}$  later. Once the read operation has taken place, a further  $300\ \text{ns}$  should be allowed before the next falling edge of  $\overline{\text{CONVST}}$  to optimize the settling of the track/hold amplifier before the next conversion is initiated. With the serial clock frequency at its maximum of  $15\ \text{MHz}$ , the achievable throughput rate for the part is  $3.8\ \mu\text{s}$  (conversion time) plus  $1.1\ \mu\text{s}$  (read time) plus  $0.3\ \mu\text{s}$  (acquisition time). This results in a minimum throughput time of  $8.2\ \mu\text{s}$  (equivalent to a throughput rate of  $192\ \text{kHz}$ ). A serial clock of less than  $15\ \text{MHz}$  can be used, but this will in turn mean that the throughput time will increase.

The read operation consists of sixteen serial clock pulses to the output shift register of the AD7895. After sixteen serial clock pulses, the shift register is reset, and the  $\overline{\text{SDATA}}$  line is three-

stated. If there are more serial clock pulses after the sixteenth clock, the shift register will be moved on past its reset state. However, the shift register will be reset again on the falling edge of the  $\overline{\text{CONVST}}$  signal to ensure that the part returns to a known state every conversion cycle. As a result, a read operation from the output register should not straddle across the falling edge of  $\overline{\text{CONVST}}$  as the output shift register will be reset in the middle of the read operation, and the data read back into the microprocessor will appear invalid.

## OPERATING MODES

### Mode 1 Operation (High Sampling Performance)

The timing diagram in Figure 3 is for optimum performance in operating Mode 1 where the falling edge of  $\overline{\text{CONVST}}$  starts conversion and puts the Track/Hold amplifier into its hold mode. This falling edge of  $\overline{\text{CONVST}}$  also causes the  $\overline{\text{BUSY}}$  signal to go high to indicate that a conversion is taking place. The  $\overline{\text{BUSY}}$  signal goes low when the conversion is complete, which is  $3.8\ \mu\text{s}$  max after the falling edge of  $\overline{\text{CONVST}}$ , and new data from this conversion is available in the output register of the AD7895. A read operation accesses this data. This read operation consists of 16 clock cycles, and the length of this read operation will depend on the serial clock frequency. For the fastest throughput rate (with a serial clock of  $15\ \text{MHz}$ ,  $5\ \text{V}$  operation) the read operation will take  $1.1\ \mu\text{s}$ . The read operation must be complete at least  $300\ \text{ns}$  before the falling edge of the next  $\overline{\text{CONVST}}$ , and this gives a total time of  $5.2\ \mu\text{s}$  for the full throughput time (equivalent to  $192\ \text{kHz}$ ). This mode of operation should be used for high sampling applications.

### Mode 2 Operation (Auto Sleep After Conversion)

The timing diagram in Figure 4 is for optimum performance in operating mode 2 where the part automatically goes into sleep mode once  $\overline{\text{BUSY}}$  goes low after conversion and "wakes-up" before the next conversion takes place. This is achieved by keeping  $\overline{\text{CONVST}}$  low at the end of conversion, whereas it was high at the end of conversion for Mode 1 Operation. The rising edge of  $\overline{\text{CONVST}}$  "wakes up" the part. This wake-up time is  $6\ \mu\text{s}$  at which point the Track/Hold amplifier goes into its hold mode, provided the  $\overline{\text{CONVST}}$  has gone low. The conversion takes  $3.8\ \mu\text{s}$  after this giving a total of  $9.8\ \mu\text{s}$  from the rising edge of  $\overline{\text{CONVST}}$  to the conversion being complete, which is indicated by the  $\overline{\text{BUSY}}$  going low. Note that since the wake-up time from the rising edge of  $\overline{\text{CONVST}}$  is  $6\ \mu\text{s}$ , when the  $\overline{\text{CONVST}}$  pulse width is greater than  $6\ \mu\text{s}$ , the conversion will take more

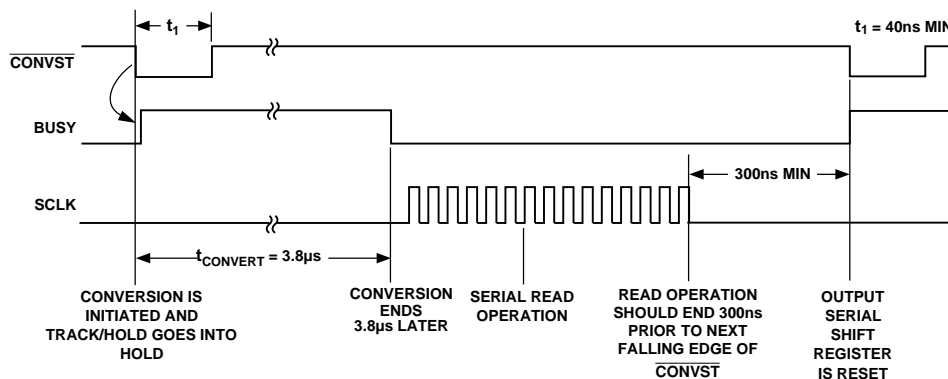

Figure 3. Mode 1 Timing Operation Diagram for High Sampling Performance

# AD7895

than the 9.8  $\mu\text{s}$  shown in diagram from the rising edge of  $\overline{\text{CONVST}}$ . This is because the Track/Hold amplifier goes into its hold mode on the falling edge of  $\overline{\text{CONVST}}$ , and the conversion will not be complete for a further 3.8  $\mu\text{s}$ . In this case, the  $\text{BUSY}$  will be the best indicator for when the conversion is complete. Even though the part is in sleep mode, data can still be read from the part. The read operation consists of 16 clock cycles as in Mode 1 Operation. For the fastest serial clock of 15 MHz, the read operation will take 1.1  $\mu\text{s}$  and this must be complete at least 300 ns before the falling edge of the next  $\overline{\text{CONVST}}$  to allow the Track/Hold amplifier to have enough time to settle. This mode is very useful when the part is converting at a slow rate as the power consumption will be significantly reduced from that of Mode 1 Operation.

## Serial Interface

The serial interface to the AD7895 consists of just three wires: a serial clock input (SCLK), the serial data output (SDATA) and a conversion status output ( $\text{BUSY}$ ). This allows for an easy-to-use interface to most microcontrollers, DSP processors and shift registers.

Figure 5 shows the timing diagram for the read operation to the AD7895. The serial clock input (SCLK) provides the clock source for the serial interface. Serial data is clocked out from the SDATA line on the falling edge of this clock and is valid on both the rising and falling edges of SCLK. The advantage of having the data valid on both the rising and falling edges of the SCLK is that it gives the user greater flexibility in interfacing to the part and allows a wider range of microprocessor and microcontroller interfaces to be accommodated. This also explains the two timing figures,  $t_4$  and  $t_5$ , that are quoted on the diagram. The time  $t_4$  specifies how long after the falling edge of the SCLK that the next data bit becomes valid, whereas the time  $t_5$  specifies how long after the falling edge of the SCLK that the current data bit is valid for. The first leading zero is clocked out on the first rising edge of SCLK. Note that the first zero will be

valid on the first falling edge of SCLK even though the data access time is specified at 60 ns for the other bits. The reason that the first bit will be clocked out faster than the other bits is due to the internal architecture of the part. Sixteen clock pulses must be provided to the part to access to full conversion result. The AD7895 provides four leading zeros, followed by the 12-bit conversion result starting with the MSB (DB11). The last data bit to be clocked out on the penultimate falling clock edge is the LSB (DB0). On the sixteenth falling edge of SCLK, the LSB (DB0) will be valid for a specified time to allow the bit to be read on the falling edge of the SCLK, then the SDATA line is disabled (three-stated). After this last bit has been clocked out, the SCLK input should return low and remain low until the next serial data read operation. If there are extra clock pulses after the sixteenth clock, the AD7895 will start over again with outputting data from its output register, and the data bus will no longer be three-stated even when the clock stops. Provided the serial clock has stopped before the next falling edge of  $\overline{\text{CONVST}}$ , the AD7895 will continue to operate correctly with the output shift register being reset on the falling edge of  $\overline{\text{CONVST}}$ . However, the SCLK line must be low when  $\overline{\text{CONVST}}$  goes low in order to reset the output shift register correctly.

The serial clock input does not have to be continuous during the serial read operation. The sixteen bits of data (four leading zeros and 12 bit conversion result) can be read from the AD7895 in a number of bytes.

The AD7895 counts the serial clock edges to know which bit from the output register should be placed on the SDATA output. To ensure that the part does not lose synchronization, the serial clock counter is reset on the falling edge of the  $\overline{\text{CONVST}}$  input, provided the SCLK line is low. The user should ensure that the SCLK line remains low until the end of the conversion. When the conversion is complete,  $\text{BUSY}$  goes low, the output register will be loaded with the new conversion result and can be read from with sixteen clock cycles of SCLK.

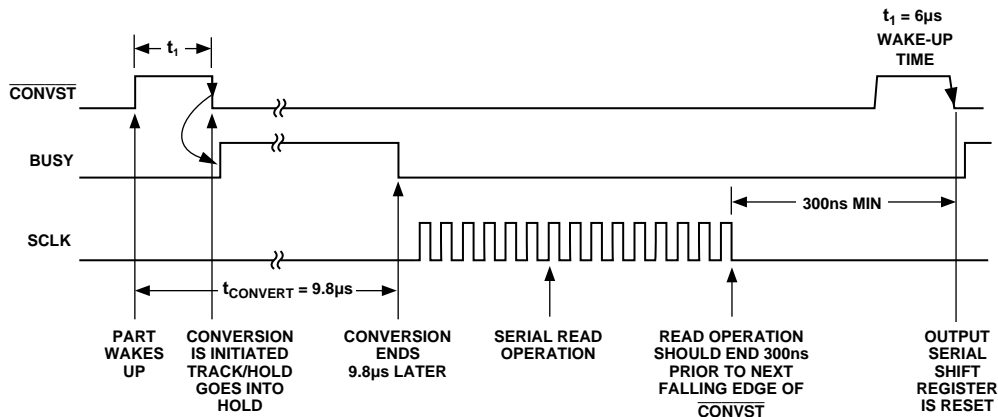

Figure 4. Mode 2 Timing Diagram Where Automatic Sleep Function Is Initiated

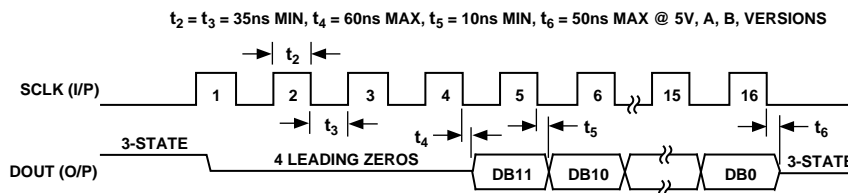

Figure 5. Data Read Operation



### MICROPROCESSOR/MICROCONTROLLER INTERFACE

The AD7895 provides a three-wire serial interface that can be used for connection to the serial ports of DSP processors and microcontrollers. Figures 6 through 9 show the AD7895 interfaced to a number of different microcontrollers and DSP processors. The AD7895 accepts an external serial clock, and as a result, in all interfaces shown here, the processor/controller is configured as the master, providing the serial clock with the AD7895 configured as the slave in the system.

#### AD7895–8051 Interface

Figure 6 shows an interface between the AD7895 and the 8XL51 microcontroller. The 8XL51 is configured for its Mode 0 serial interface mode. The diagram shows the simplest form of the interface where the AD7895 is the only part connected to the serial port of the 8XL51 and, therefore, no decoding of the serial read operations is required.

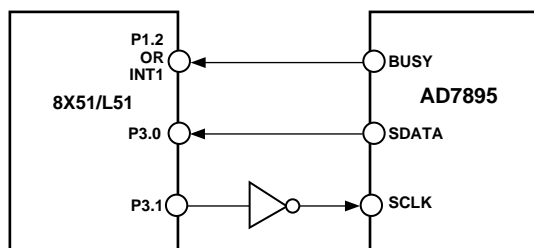

Figure 6. AD7895 to 8X51/L51 Interface

To chip select the AD7895 in systems where more than one device is connected to the 8XL51's serial port, a port bit configured as an output, from one of the 8XL51's parallel ports can be used to gate on or off the serial clock to the AD7895. A simple AND function on this port bit and the serial clock from the 8XL51 will provide this function. The port bit should be high to select the AD7895 and low when it is not selected.

The end of conversion is monitored by using the BUSY signal that is shown in the interface diagram of Figure 6. The BUSY line from the AD7895 is connected to the Port P1.2 of the 8XL51 so the BUSY line can be polled by the 8XL51. The BUSY line can be connected to the INT1 line of the 8XL51 if an interrupt driven system is preferred. These two options are shown in the diagram.

Note also that the AD7895 outputs the MSB first during a read operation, while the 8XL51 expects the LSB first. Therefore, the data which is read into the serial buffer needs to be rearranged before the correct data format from the AD7895 appears in the accumulator.

The serial clock rate from the 8XL51 is limited to significantly less than the allowable input serial clock frequency with which the AD7895 can operate. As a result, the time to read data from the part will actually be longer than the conversion time of the part. This means that the AD7895 cannot run at its maximum throughput rate when used with the 8XL51.

#### AD7895–68HC11/L11 Interface

An interface circuit between the AD7895 and the 68HC11/L11 microcontroller is shown in Figure 7. For the interface shown, the 68L11 SPI port is used, and the 68L11 is configured in its single-chip mode. The 68L11 is configured in the master mode with its CPOL bit set to a logic zero and its CPHA bit set to a logic one. As with the previous interface, the diagram shows the simplest form of the interface where the AD7895 is the only part connected to the serial port of the 68L11 and, therefore, no decoding of the serial read operations is required.

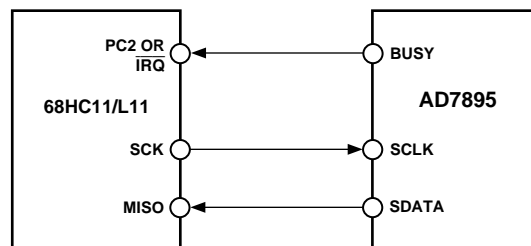

Figure 7. AD7895 to 68HC11/L11 Interface

Once again, to chip select the AD7895 in systems where more than one device is connected to the 68HC11's serial port, a port bit configured as an output from one of the 68HC11's parallel ports can be used to gate on or off the serial clock to the AD7895. A simple AND function on this port bit and the serial clock from the 68L11 will provide this function. The port bit should be high to select the AD7895 and low when it is not selected.

The end of conversion is monitored by using the BUSY signal that is shown in the interface diagram of Figure 7. With the BUSY line from the AD7895 connected to the Port PC0 of the 68HC11/L11, the BUSY line can be polled by the 68HC11/L11. The BUSY line can be connected to the  $\overline{\text{IRQ}}$  line of the 68HC11/L11 if an interrupt driven system is preferred. These two options are shown in the diagram.

The serial clock rate from the 68HC11/L11 is limited to significantly less than the allowable input serial clock frequency with which the AD7895 can operate. As a result, the time to read data from the part will actually be longer than the conversion time of the part. This means that the AD7895 cannot run at its maximum throughput rate when used with the 68HC11/L11.

#### AD7895–ADSP-2103/5 Interface

An interface circuit between the AD7895 and the ADSP-2103/5 DSP processor is shown in Figure 8. In the interface shown, the RFS1 output from the ADSP-2103/5s SPORT1 serial port is used to gate the serial clock (SCLK1) of the ADSP-2103/5 before it is applied to the SCLK input of the AD7895. The RFS1 output is configured for active high operation. The BUSY line from the AD7895 is connected to the  $\overline{\text{IRQ2}}$  line of the ADSP-2103/5 so that at the end of conversion an interrupt is generated telling the ADSP-2103/5 to initiate a read operation. The interface ensures a noncontinuous clock for the AD7895's serial clock input with only sixteen serial clock pulses provided and the serial clock line of the AD7895 remaining low between data transfers. The SDATA line from the AD7895 is connected to the DR1 line of the ADSP-2103/5's serial port.

# AD7895

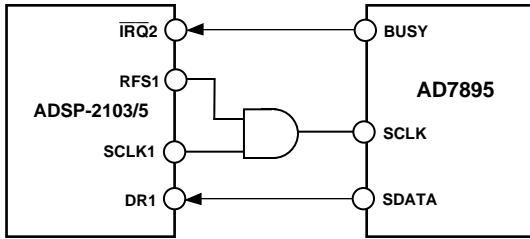

Figure 8. AD7895 to ADSP-2103/5 Interface

The timing relationship between the SCLK1 and RFS1 outputs of the ADSP-2103/5 are such that the delay between the rising edge of the SCLK1 and the rising edge of an active high RFS1 is up to 30 ns. There is also a requirement that data must be set up 10 ns prior to the falling edge of the SCLK1 to be read correctly by the ADSP-2103/5. The data access time for the AD7895 is 60 ns (5 V (A, B versions)) from the rising edge of its SCLK input. Assuming a 10 ns propagation delay through the external AND gate, the high time of the SCLK1 output of the ADSP-2105 must be  $\geq (30 + 60 + 10 + 10)$  ns, i.e.,  $\geq 110$  ns. This means that the serial clock frequency with which the interface of Figure 8 can work is limited to 4.5 MHz. However, there is an alternative method that allows for the ADSP-2105 SCLK1 to run at 5 MHz (the max serial clock frequency of the SCLK1 output). The arrangement occurs when the first leading zero of the data stream from the AD7895 cannot be guaranteed to be clocked into the ADSP-2105 due to the combined delay of the RFS signal and the data access time of the AD7895. In most cases, this is acceptable because there will still be three leading zeros followed by the 12 data bits. For the ADSP-2103, the SCLK1 frequency will need to be limited to  $< 4$  MHz to account for the 100 ns data access time of the AD7895. Another alternative scheme is to configure the ADSP-2103/5 so that it accepts an external noncontinuous serial clock. In this case, an external noncontinuous serial clock is provided that drives the serial clock inputs of both the ADSP-2103/5 and the AD7895. In this scheme, the serial clock frequency is limited to 15 MHz by the AD7895.

## AD7895–DSP56002/L002 Interface

Figure 9 shows an interface circuit between the AD7895 and the DSP56002/L002 DSP processor. The DSP56002/L002 is configured for normal mode asynchronous operation with gated clock. It is also set up for a 16-bit word with SCK as gated clock output. In this mode, the DSP56002/L002 provides sixteen serial clock pulses to the AD7895 in a serial read operation. Because the DSP56002/L002 assumes valid data on the first falling edge of SCK, the interface is simply two-wire as shown in Figure 9.

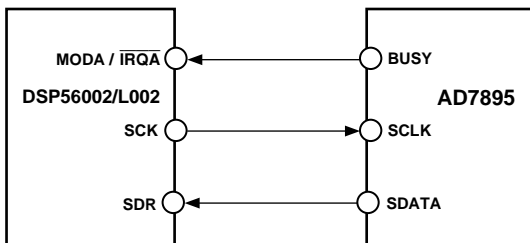

Figure 9. AD7895 to DSP56002/L002 Interface

Because the BUSY line from the AD7895 is connected to the MODA/IRQA input of the DSP56002/L002, an interrupt will be generated at the end of conversion. This ensures that the read operation will take place after conversion is finished.

## AD7895 PERFORMANCE

### Linearity

The linearity of the AD7895 is determined by the on-chip 12-bit D/A converter. This is a segmented DAC that is laser trimmed for 12-bit integral linearity and differential linearity. Typical relative accuracy numbers for the part are  $\pm 1/4$  LSB while the typical DNL errors are  $\pm 1/2$  LSB.

### Noise

In an A/D converter, noise exhibits itself as code uncertainty in dc applications and as the noise floor (in an FFT, for example) in ac applications. In a sampling A/D converter like the AD7895, all information about the analog input appears in the baseband from dc to 1/2 the sampling frequency. The input bandwidth of the track/hold exceeds the Nyquist bandwidth and, therefore, an antialiasing filter should be used to remove unwanted signals above  $f_s/2$  in the input signal in applications where such signals exist.

Figure 10 shows a histogram plot for 8192 conversions of a dc input using the AD7895. The analog input was set at the center of a code transition. It can be seen that almost all the codes appear in the one output bin, indicating very good noise performance from the ADC.

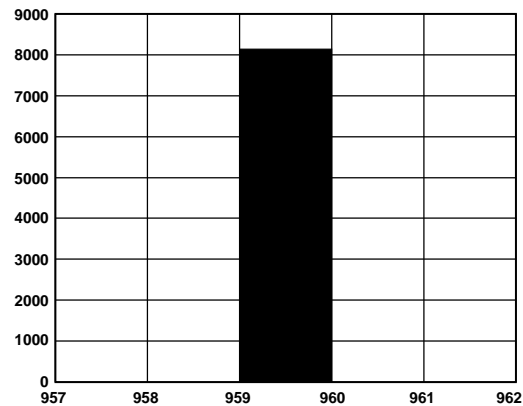

Figure 10. Histogram of 8192 Conversions of a DC Input

In this case where the output data read for the device occurs during conversion, this has the effect of injecting noise onto the die while bit decisions are being made, and this increases the noise generated by the AD7895. A histogram plot for 8192 conversions of the same dc input would show a larger spread of codes with the rms noise for the AD7895 increasing. This effect will vary depending on where the serial clock edges appear with respect to the bit trials of the conversion process. It is possible to achieve the same level of performance when reading during conversion as when reading after conversion, depending on the relationship of the serial clock edges to the bit trial points.

### Dynamic Performance (Mode 1 Only)

With a combined conversion and acquisition time of 4.1  $\mu\text{s}$ , the AD7895 is ideal for wide bandwidth signal processing applications. These applications require information on the ADC's effect on the spectral content of the input signal. Signal to (Noise + Distortion), Total Harmonic Distortion, Peak Harmonic or Spurious Noise, and Intermodulation Distortion are all specified. Figure 11 shows a typical FFT plot of a 10 kHz, 0 V to +5 V input after being digitized by the AD7895 operating at a 198.656 kHz sampling rate. The Signal to (Noise + Distortion) Ratio is 73.04 dB, and the Total Harmonic Distortion is -84.91 dB.

The formula for Signal to (Noise + Distortion) Ratio (see Terminology section) is related to the resolution or number of bits in the converter. Rewriting the formula, below, gives a measure of performance expressed in effective number of bits (N):

$$N = (\text{SNR} + 1.76)/6.02$$

where SNR is Signal to (Noise + Distortion) Ratio.

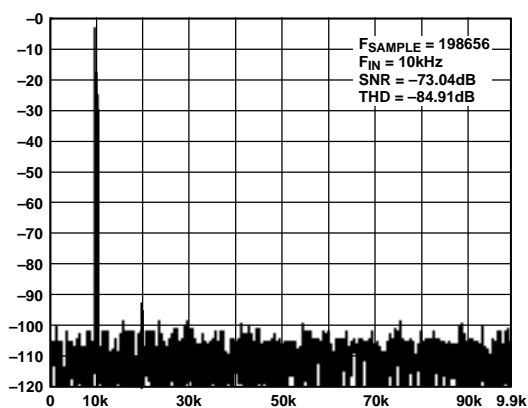

Figure 11. AD7895 FFT Plot Effective Number of Bits

The effective number of bits for a device can be calculated from its measured Signal to (Noise + Distortion) Ratio. Figure 12 shows a typical plot of effective number of bits versus frequency for the AD7895 from dc to  $f_{\text{SAMPLING}}/2$ . The sampling frequency is 198.656 kHz. The plot shows that the AD7895 converts an input sine wave of 10 kHz to an effective number of bits of 11.84, which equates to a Signal to (Noise + Distortion) level of 73.04 dB.

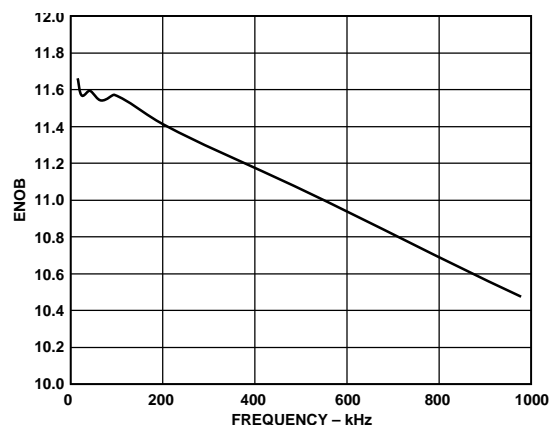

Figure 12. Effective Number of Bits vs. Frequency

### Power Considerations

In the automatic power-down mode, then, the part may be operated at a sample rate that is considerably less than 100 kHz. In this case, the power consumption will be reduced and will depend on the sample rate. Figure 13 shows a graph of the power consumption versus sampling rates from 100 Hz to 90 kHz in the automatic power-down mode. The conditions are 5 V supply 25°C, serial clock frequency of 8.33 MHz, and the data was read after conversion.

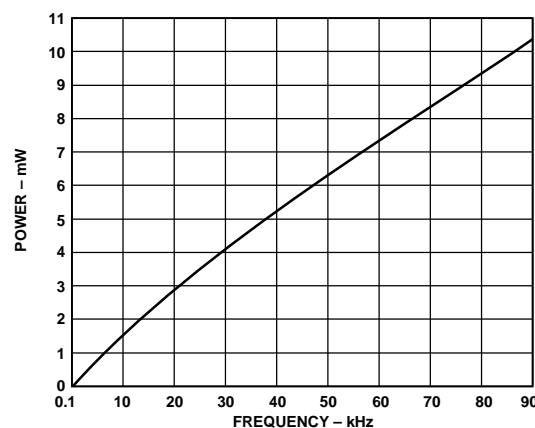
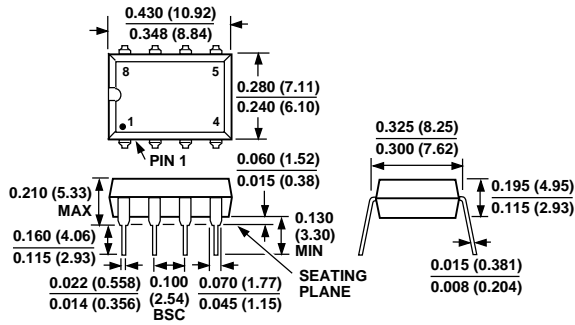

Figure 13. Power vs. Sample Rate in Auto Power-Down Mode

## OUTLINE DIMENSIONS

Dimensions shown in inches and (mm).

### Plastic DIP (N-8)



### SOIC (SO-8)

